

# jeremias

Chimney, Duct & Ventilation Systems

## CATÁLOGO LISTA DE PRECIOS 2026

Calefacción  
Resistencia al fuego  
Biomasa  
Chimeneas Industriales Autoportantes  
Silenciadores  
Ventilación Mecánica Controlada (VMC)



# Jeremias

+ de 50 años de trayectoria que nos han convertido en referente a nivel mundial.

**JEREMIAS** Grupo es un holding industrial de origen alemán, líder en la **fabricación de productos para la evacuación de humos y gases**, así como de soluciones que abarcan desde la Calefacción, Resistencia al fuego, Ventilación Residencial, Combustibles sólidos, Industrial.

Con **más de 50 años de historia**, Jeremias cuenta con una gran proyección internacional. Un grupo que se ha expandido por Europa y Norteamérica que cuenta con 10 plantas industriales y presentes en más de 60 países.

Para Jeremias la innovación, la vocación al servicio, el cliente, la calidad de sus productos y el respeto por el medio ambiente, son valores fundamentales.



**60**

Presencia en más de 60 países



**100K**

Más de 100K referencias



**11**

11 plantas de fabricación



**1.650**

Más de 1.650 personas





# SOLUCIONES SENCILLAS DECISIONES INTELIGENTES

**Jeremias España** pertenece a Jeremias Grupo, fundada en el 2007 tiene una de las plantas de fabricación más modernas de Europa en su sector.

Posee además un sistema de almacén automático que permite utilizar los sistemas más innovadores en logística y una gran capacidad de almacenamiento.

La calidad, la innovación, el diseño y la comercialización, han asegurado el éxito de Jeremias.

**Nuestra presencia mundial y nuestro amplio conocimiento sobre sistemas de evacuación de humos, nos permite ofrecerte las mejores soluciones en:**

- Chimeneas modulares metálicas para **calderas domesticas o industriales.**
- **Conductos resistentes al fuego EI** en cocinas industriales.
- Salidas de escape para **grupos electrógenos, cogeneración, incineradoras.**
- **Chimeneas industriales** para hornos y procesos industriales.
- Chimeneas **autoportantes.**
- Chimeneas **colectivas para la evacuación de gases** de calderas murales.
- Sistemas de Ventilación Mecánica Controlada - **VMC.**
- **Chimeneas para soluciones en Biomasa.**
- **Silenciadores** para el sector terciario e industrial.
- Conductos para **campanas extractoras domésticas.**
- Conductos para **bajantes de lavandería** y residuos en edificios.



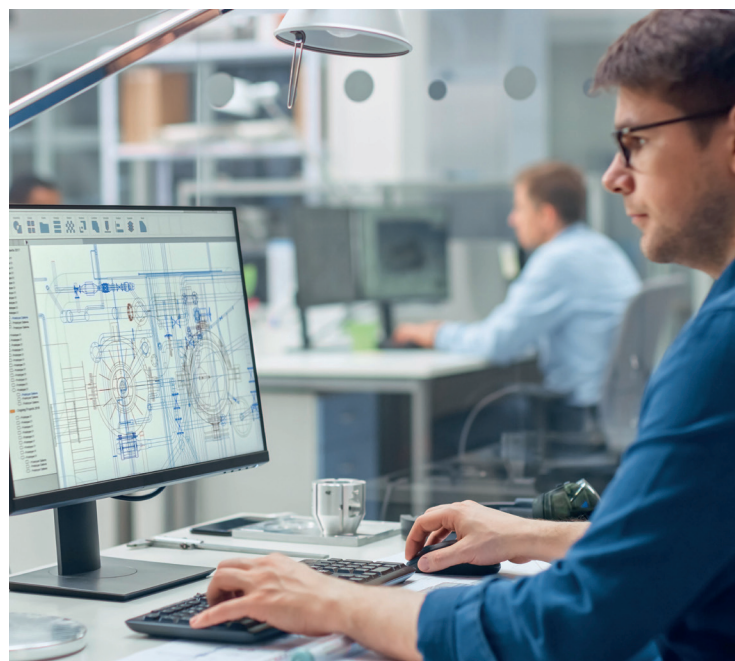

## Nuestro equipo

**Jeremias** cuenta con un equipo humano altamente cualificado formado por más de 250 profesionales repartidos entre la fábrica de Bilbao y las oficinas de Madrid, Barcelona y Coruña.

Amplia red de técnicos comerciales a nivel estatal que garantizan una asistencia rápida y eficaz en cualquier momento.

## Calidad

Nos acreditan como una empresa que cumple con los estándares de calidad, organización, gestión y desarrollo.

Los productos de **Jeremias** pasan estrictos controles de calidad para asegurar su correcto funcionamiento y durabilidad.

El compromiso que adquiere Jeremias con la calidad queda patente en la renovación de los certificados.

A día de hoy Jeremias cuenta con más de 100 sistemas certificados según las diferentes normativas (Europea CE, Americana UL, Británica HETAS, TUV, Francesa NF...) disponiendo además de Certificaciones específicas para cada país y consejos de instalación.

## Nuestros servicios



Consultoría



Diseño



Fabricación



Instalación



## Jeremias España



### Delegaciones

#### Madrid

C/ Azalea 1, Miniparc Bloque F  
28109 Alcobendas  
Tlf: +34 910 748 802  
madrid@jeremias.es

#### Barcelona

Carrer Porvenir, 48,  
08912 Badalona  
Tlf: +34 934 644 184  
catalunya@jeremias.es

#### Coruña

Tlf: +34 646 430 504  
coruna@jeremias.es

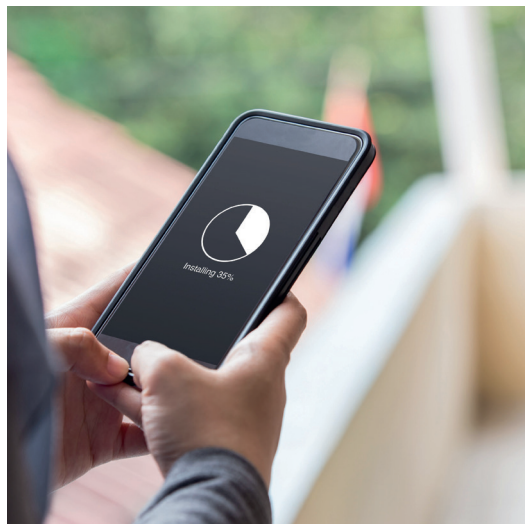

### Asistencia telefónica

Tlf: +34 946 30 10 10  
info@jeremias.es

#### ¿Qué tipo de profesional eres?

Los productos **Jeremias** están dirigidos a instaladores, ingenieros, promotores, mantenedoras, constructoras, estudios de arquitectura, distribuidores, profesionales del sector...

#### Todos los recursos para profesionales

Disponemos de todo lo que necesitas para tus proyectos, catálogos, objetos BIM, software gratuito, proyectos de referencia, recursos técnicos para tu día a día, vídeos de instalación, manuales de instrucciones, manuales técnicos y mucho más.

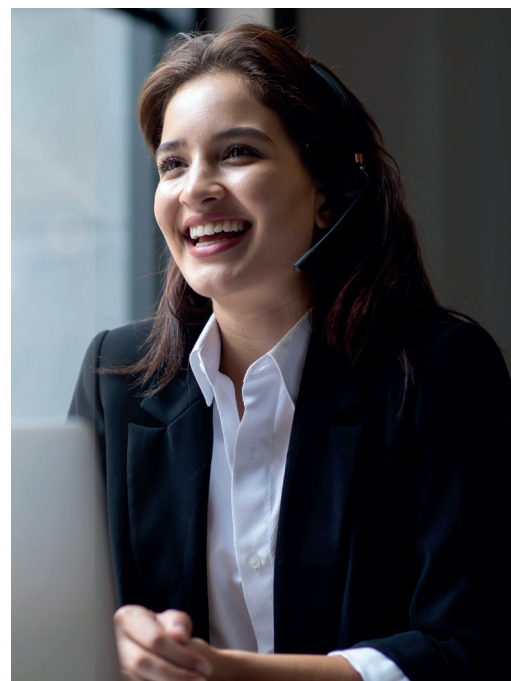

# 02

Presentación	02
Acabados especiales	10
Simbología	11



## 15

### Calefacción

<b>INDIVIDUAL</b>	<b>16</b>
DW-ECO 2.0 316	18
DW-ECO 2.0 304	32
DW-ECO 1.0 316	42
DW-ECO 1.0 304	50
Cómo cortar un módulo recto de DW-FT	55
EW-ECO CONDENSING	58
EW-ECO 316	68
EW-ECO 304	79
TWIN-ECO 316	90
Abrazadera de separación	93
<b>COLECTIVA</b>	<b>94</b>
SED	96
SEE	100
SVC	104
<b>CONEXIONES</b>	<b>108</b>
TWIN-PL	108
EW-PPS	111
<b>TERMINALES</b>	<b>117</b>



## 119

### Resistencia al fuego

DW-FT EI30	122
SV-FT EI60	130
SV-FT EI120/240	138



## 147

### Biomasa

DW-ECO 1.0 316 SCHWARZ	150
FERRO-LUX	155
EW-VITRO	159
FLEX-LINE	161
TWIN-BIOMASS NEGRO	163
EW-PELLETS NEGRO	167
EW-PELLETS INOX	171
VITRO-PELLETS	173
Accesorios	175

# Índice



## Extracción industrial

<b>GRUPOS ELECTRÓGENOS</b>	<b>180</b>
DW-KL 32 304	182
DW-KL 50 304	189
Accesorios DW-KL	196
Cómo cortar un módulo cortable de DW-KL	196



## Chimeneas industriales

<b>CHIMENEAS AUTOPORTANTES</b>	<b>200</b>
FSA	202
FSB	203
FSA-X	204
FSC	205
Estructuras autoportantes	206
<b>SILENCIADORES</b>	<b>211</b>



## Ventilación Mecánica Controlada

Recuperadores	224
Extractores	231
Accesorios	233
Conductos de ventilación	240
<b>BAJANTES</b>	<b>269</b>
Clean Duct Pro	270
Clean Duct Home	275

# 281

<b>HERRAMIENTAS</b>	<b>283</b>
Ventbom	284
Easy-Calc	285
<b>Garantía</b>	<b>287</b>
<b>Referencias</b>	<b>290</b>

## Acabados Especiales

Dependiendo de sus necesidades, podemos ofrecerle nuestro servicio personalizado de pintura RAL.

### COLORES RAL ESTANDARD JEREMIAS



Amarillo narciso  
(mate)



Marfil claro  
(mate)



Azul ultramar  
(mate)



Azul luminoso  
(mate)



Gris ratón  
(mate)



Gris antracita  
(mate)



Pardo cobre  
(mate)



Sepia  
(mate)



Pardo grisáceo  
(mate)



Negro señales  
(mate)



Negro intenso  
(mate)



Negro grafito  
(mate)



Blanco tráfico  
(mate)



Blanco tráfico  
(brillante)

(Precio +30% para gamas de doble pared aisladas)  
(Consultar precios para resto de gamas)

Para otros colores RAL, consultar precio y disponibilidad.

\*Los colores que se muestran pueden sufrir alguna variación, según la resolución de la pantalla utilizada o la impresión.



## Leyenda Simbología



Garantía



Madera



Condiciones  
secas



Condensación



0,5 mm

Espesor  
de acero

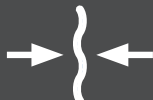

0,08 mm

Flexible



N1 40 Pa

Tiro natural  
depresión



P1 200 Pa

Tiro forzado  
sobrepresión



H1 5000 Pa

Tiro forzado  
sobrepresión



Concéntrico  
doble pared  
sin aislar



Simple pared



25 mm

Espesor de  
aislamiento



25 mm

Concéntrico triple  
pared aislado



Gasoil



Gas natural



600°C

Temperatura  
de trabajo



Pellets

## Iconos Aplicaciones



Calefacción



Resistencia  
al fuego



Residencial  
VMC



Accesorios



Industrial



Ventilación



Combustibles sólidos

## Primera línea de Chimeneas de Acero Inoxidable Premium de bajas emisiones del mundo.

Con 3 indicadores validados en una herramienta exclusiva.

Descubre la primera línea que da respuesta directa a la creciente necesidad del mercado de reducir sus Emisiones de Alcance 3 y en la que Jeremias confía como una inversión estratégica para continuar aportando soluciones sostenibles que influyan positivamente en toda la cadena de valor del sector.

Ya puedes solicitar todas las gamas en acero inoxidable Blueline.



**Energía renovable**



**Material reciclado**



**Huella de carbono**





VER VIDEO

## Ventajas principales de Blueline

La nueva línea de chimeneas de acero inoxidable premium de bajas emisiones de Jeremias conseguirá que **tus proyectos cumplan con los mayores estándares de sostenibilidad y eficiencia energética.**

Una línea que mantiene todas las ventajas y características de nuestras chimeneas y conductos DW-ECO, DW-KL y Resistencia al Fuego a las que ahora además se suma el **componente ecológico y de bajas emisiones.**

# 90%

Material reciclado

# -50%

Reducción de la huella de carbono

Toneladas de CO<sub>2</sub>/Toneladas de Acero Inoxidable

# 100%

Energías renovables utilizadas para su producción

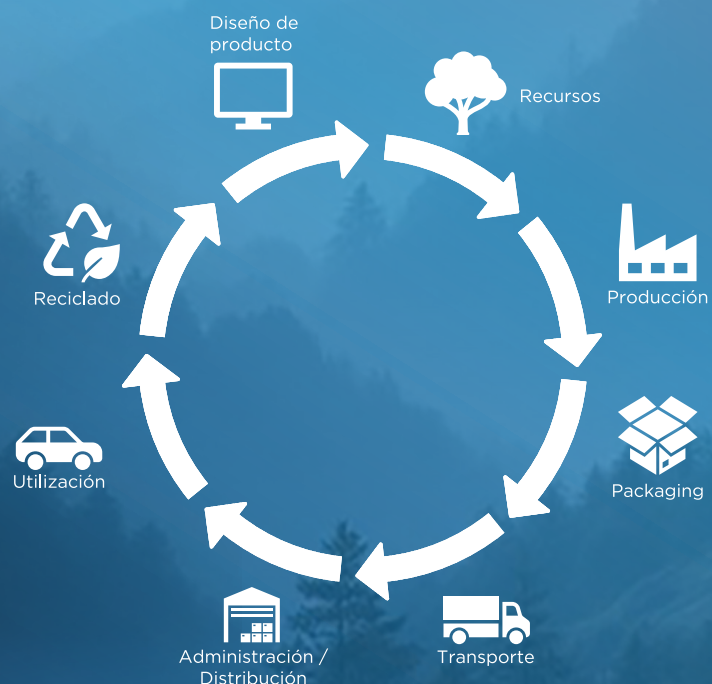





# Calefacción



## Índice

<b>INDIVIDUAL</b>	<b>16</b>
DW-ECO 2.0 316	18
DW-ECO 2.0 304	32
DW-ECO 1.0 316	42
DW-ECO 1.0 304	50
Cómo cortar un módulo recto de DW-FT	55
EW-ECO CONDENSING	58
EW-ECO 316	68
EW-ECO 304	79
TWIN-ECO 316	90
Abrazadera de separación	93
<b>COLECTIVA</b>	<b>94</b>
SED	96
SEE	100
SVC	104
SET	111
<b>CONEXIONES</b>	<b>115</b>
<b>TERMINALES</b>	<b>117</b>



## Chimeneas Doble Pared para Calderas

Para todas las aplicaciones indicadas se utiliza el sistema DW-ECO en sus diferentes versiones en 304 (gas natural y gasoil en condiciones secas) y 316 (condensación y combustibles sólidos).

Es una chimenea modular fabricada en acero inoxidable interior y exterior con aislamiento intermedio de lana de roca rígida, que nos permite evitar cualquier puente térmico entre pared interior y exterior, además de la posibilidad de cortar a medida los tramos rectos en la propia instalación (una ventaja enorme para la instalación en las condiciones más complicadas).



### APLICACIONES

- Calderas de gas
- Calderas de gasoil
- Calderas de combustibles sólidos
- Condensación
- Calderas de vapor
- Estufas y fuegos bajos
- Generadores de aire caliente
- Hornos de panadería
- Climatización
- Hornos incineradores

	Gas natural	Gasoil	Comb. Sólidos	Condensación	Condiciones húmedas	Temperatura (°C)	Material interior	Material exterior	Espesor mat. Interior (mm)	N= tiro natural P= sobrepresión H=altas presiones	Resist. fuego de hollín
DW-ECO 1.0 304	●	●	-	-	-	600	AISI 304	AISI 304	0.4	N	●
	●	●	-	-	-	450	AISI 304	AISI 304	0.4	N	●
	●	●	-	-	●	400	AISI 304	AISI 304	0.4	N	-
	●	●	-	-	●	200	AISI 304	AISI 304	0.4	H	-
DW-ECO 1.0 316	●	●	●	-	-	600	AISI 316L	AISI 304	0.4	N	●
	●	●	●	-	-	450	AISI 316L	AISI 304	0.4	N	●
	●	●	-	-	●	400	AISI 316L	AISI 304	0.4	N	-
	●	●	-	-	●	200	AISI 316L	AISI 304	0.4	H	-
	●	●	-	●*	●	120	AISI 316L	AISI 304	0.4	H	-
DW-ECO 2.0 316	●	●	●	-	-	600	AISI 316L	AISI 304	0.4 - 0.5 - 0.6 según Ø	N	●
	●	●	●	-	-	450	AISI 316L	AISI 304	0.4 - 0.5 - 0.6 según Ø	N	●
	●	●	-	-	●	400	AISI 316L	AISI 304	0.4 - 0.5 - 0.6 según Ø	N	-
	●	●	-	-	●	200	AISI 316L	AISI 304	0.4 - 0.5 - 0.6 según Ø	H	-
	●	●	-	●*	●	120	AISI 316L	AISI 304	0.4 - 0.5 - 0.6 según Ø	H	-
DW-ECO 2.0 304	●	●	-	-	-	600	AISI 304	AISI 304	0.4 - 0.5 - 0.6 según Ø	N	●
	●	●	-	-	-	450	AISI 304	AISI 304	0.4 - 0.5 - 0.6 según Ø	N	●
	●	●	-	-	●	400	AISI 304	AISI 304	0.4 - 0.5 - 0.6 según Ø	H	-
	●	●	-	●	●	200	AISI 304	AISI 304	0.4 - 0.5 - 0.6 según Ø	H	-



Con junta de condensación.

1. Terminal salida cónica (DWECO32C)
2. Módulo recto 1.000 mm (DWECO13)
3. Abrazadera fijación pared (DW25556)
4. Te 90° (DWECO317)
5. Estabilizador de tiro (adaptador+clapeta) (DWECO970)
6. Módulo recto 250 mm (DWECO15)
7. Soporte de carga regulable (DWECO379)
8. Colector de hollín con desagüe aislado (DWECO1460)
9. Te 90° de boca reducida (DWECT902)
10. Abrazadera de amarre por tornillo (DWECO1063)
11. Colector de hollín con desagüe lateral (DWECO1)
12. Ampliación excéntrica (DWECOAX)
13. Codo 90° (DWECO60)
14. Adaptador caldera macho (DWECO37M)



### Pesos alturas entre soportes

Pesos aproximados por metro lineal de chimenea en cada modelo y diámetro, así como las alturas máximas entre soportes de carga en función del diámetro para instalación vertical. En la base de la vertical es necesaria la colocación de un soporte de carga encima de la conexión (si se coloca debajo la altura al segundo soporte se reducirá a la mitad).

Asimismo, en instalación horizontal se recomienda que la distancia entre abrazaderas de fijación sea de 2 m. En instalación vertical la distancia entre abrazaderas de fijación pared debe ser de 4 m como máximo.

La máxima altura en voladizo por encima de la última conexión es de 3 m. (Dependiendo del diámetro. Consultar DOP).



### PESOS (kg)

	DW-ECO 1.0 304	DW-ECO 1.0 316	DW-ECO 2.0 316	DW-ECO 2.0 304
Ø 80	-	3,3	3,3	-
Ø 100	-	3,9	3,9	-
Ø 130	4,9	4,9	4,9	-
Ø 150	5,5	5,5	5,5	-
Ø 180	6,4	6,4	6,4	-
Ø 200	7,0	7,0	7,0	-
Ø 250	-	-	8,6	8,6
Ø 300	-	-	10,2	10,2
Ø 350	-	-	13,7	13,7
Ø 400	-	-	15,6	15,6
Ø 450	-	-	17,4	17,4
Ø 500	-	-	19,2	19,2
Ø 550	-	-	21,1	21,1
Ø 600	-	-	26,2	26,2
Ø 650	-	-	30,7	30,7
Ø 700	-	-	32,9	32,9
Ø 750	-	-	35,2	35,2
Ø 800	-	-	37,4	37,4



# CHIMENEA INDIVIDUAL

## Sistema DW - ECO 2.0 316

**Chimenea modular metálica para evacuación de humos y gases de los productos de la combustión de doble pared fabricada en acero inoxidable interior y exterior.**

### MATERIAL

Pared Interior: AISI 316L  
Pared Exterior: AISI 304

### ACABADO EXTERIOR

Brillante  
Colores RAL (consulta página 14 para acabados especiales)  
Exterior galvanizado / zincado -15% (sólo tramos rectos y desviaciones)

### AISLAMIENTO

Lana de roca rígida de alta densidad (120kg/m<sup>3</sup>)

### ESPEORES (mm)

Pared interior: 0,4 - 0,5 - 0,6 - 0,8 (según diámetro)  
Aislamiento: 25 mm (32 mm a partir de Ø650 mm)  
Pared exterior: 0,4 - 0,5 - 0,6 - 0,8 (según diámetro)

### DIÁMETROS DISPONIBLES (mm)

Ø13080 a Ø800

### SISTEMA DE UNIÓN

Conexión macho-hembra con **abrazadera de unión ancha (2.0)**

### NIVEL DE ESTANQUEIDAD

T--- - N1: Sin necesidad de junta  
T120 - H1: Incluir junta de condensación (DW2526CØ).  
T200 - H1: Incluir junta de estanqueidad (DW2526Ø).\*

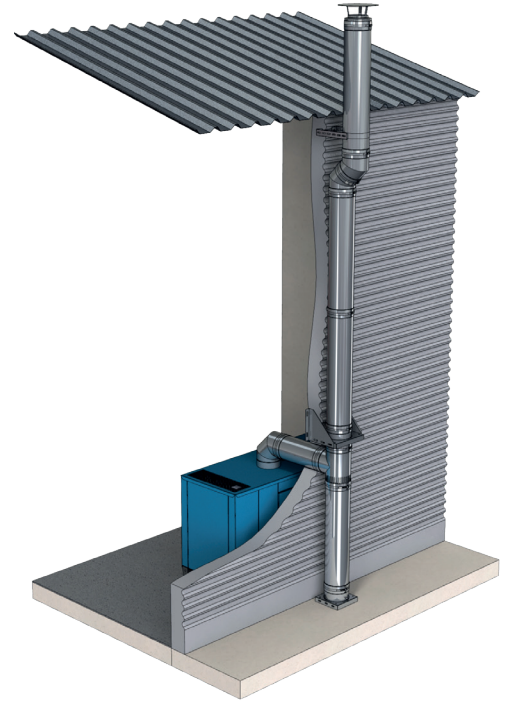

Para incluir la junta de condensación (T<120°C) preinstalada de fábrica, sustituir el código del sistema 661 por D15\*.  
Para incluir la junta de estanqueidad (T<200°C), preinstalada de fábrica, sustituir el código del sistema 661 por D01\*.  
Excepto terminales.



### APLICACIONES

- Calderas de condensación
- Calderas de combustibles sólidos
- Hornos de panadería
- Calderas de vapor
- Extracción de productos químicos (no clorados)
- Hornos incineradores



### CARACTERÍSTICAS

- Temperatura de trabajo hasta 600°C
- **Soldadura TIG/LÁSER** en continuo en todas las piezas
- **Abrazadera de unión incluida (excepto terminales)**
- Posibilidad de **corte de módulos rectos a medida** en obra (ver instrucciones de corte página 53)
- **Para condensación es necesaria la junta de condensación (DW2526C) en las uniones y una pendiente mínima de 3° en tramos horizontales (T<120°C)**
- Chimenea con clasificación de **resistencia al fuego**

### CERTIFICADO CE

0036 CPR 9174 030  
0036 CPR 9174 044

### CLASIFICACIONES CE (UNE-EN 1856-1)

T600 - N1 - D - V3 - L50040 - G(70)  
T450 - N1 - D - V3 - L50040 - G(60)  
T400 - N1 - W - V2 - L50040 - O(30)  
T200 - H1 - W - V2 - L50040 - O(20) (con junta de estanqueidad DW2526)  
T120 - H1 - W - V2 - L50040 - O(00) (con junta de condensación DW2526C)

### CLASIFICACIONES DE RESISTENCIA AL FUEGO SEGÚN EN 13501-2

EI180 ve (o-->i) T200  
EI120 ve (o-->i) T600  
EI120 ho (o-->i) T600



Módulo recto 1000mm



Módulo recto 500mm



Módulo recto 250mm



Módulo recto 250mm con  
desagüe lateral



Módulo recto regulable  
400-560mm

Ø80	661-DWECO130080	166€	Ø80	661-DWECO140080	119€	Ø80	661-DWECO150080	84€	Ø80	661-DWECO15D0080	121€	Ø80	661-DWECO5440080	166€
Ø100	661-DWECO130100	170€	Ø100	661-DWECO140100	123€	Ø100	661-DWECO150100	90€	Ø100	661-DWECO15D0100	129€	Ø100	661-DWECO5440100	170€
Ø130	661-DWECO130130	178€	Ø130	661-DWECO140130	132€	Ø130	661-DWECO150130	97€	Ø130	661-DWECO15D0130	139€	Ø130	661-DWECO5440130	178€
Ø150	661-DWECO130150	200€	Ø150	661-DWECO140150	150€	Ø150	661-DWECO150150	101€	Ø150	661-DWECO15D0150	151€	Ø150	661-DWECO5440150	199€
Ø180	661-DWECO130180	241€	Ø180	661-DWECO140180	173€	Ø180	661-DWECO150180	122€	Ø180	661-DWECO15D0180	170€	Ø180	661-DWECO5440180	233€
Ø200	661-DWECO130200	280€	Ø200	661-DWECO140200	205€	Ø200	661-DWECO150200	140€	Ø200	661-DWECO15D0200	188€	Ø200	661-DWECO5440200	267€
Ø250	661-DWECO130250	335€	Ø250	661-DWECO140250	221€	Ø250	661-DWECO150250	157€	Ø250	661-DWECO15D0250	206€	Ø250	661-DWECO5440250	306€
Ø300	661-DWECO130300	411€	Ø300	661-DWECO140300	271€	Ø300	661-DWECO150300	204€	Ø300	661-DWECO15D0300	260€	Ø300	661-DWECO5440300	401€
Ø350	661-DWECO130350	521€	Ø350	661-DWECO140350	370€	Ø350	661-DWECO150350	250€	Ø350	661-DWECO15D0350	287€	Ø350	661-DWECO5440350	502€
Ø400	661-DWECO130400	617€	Ø400	661-DWECO140400	439€	Ø400	661-DWECO150400	316€	Ø400	661-DWECO15D0400	351€	Ø400	661-DWECO5440400	622€
Ø450	661-DWECO130450	667€	Ø450	661-DWECO140450	457€	Ø450	661-DWECO150450	358€	Ø450	661-DWECO15D0450	401€	Ø450	661-DWECO5440450	655€
Ø500	661-DWECO130500	729€	Ø500	661-DWECO140500	497€	Ø500	661-DWECO150500	391€	Ø500	661-DWECO15D0500	471€	Ø500	661-DWECO5440500	690€
Ø550	661-DWECO130550	821€	Ø550	661-DWECO140550	577€	Ø550	661-DWECO150550	447€	Ø550	661-DWECO15D0550	592€	Ø550	661-DWECO5440550	728€
Ø600	661-DWECO130600	896€	Ø600	661-DWECO140600	629€	Ø600	661-DWECO150600	511€	Ø600	661-DWECO15D0600	707€	Ø600	661-DWECO5440600	818€
Ø650	661-DWECO130650	1166€	Ø650	661-DWECO140650	822€	Ø650	661-DWECO150650	666€	Ø650	661-DWECO15D0650	923€	Ø650	661-DWECO5440650	1066€
Ø700	661-DWECO130700	1237€	Ø700	661-DWECO140700	870€	Ø700	661-DWECO150700	707€	Ø700	661-DWECO15D0700	983€	Ø700	661-DWECO5440700	1127€
Ø750	661-DWECO130750	1313€	Ø750	661-DWECO140750	922€	Ø750	661-DWECO150750	752€	Ø750	661-DWECO15D0750	1037€	Ø750	661-DWECO5440750	1194€
Ø800	661-DWECO130800	1456€	Ø800	661-DWECO140800	1024€	Ø800	661-DWECO150800	832€	Ø800	661-DWECO15D0800	1157€	Ø800	661-DWECO5440800	1325€



Módulo recto regulable  
560-920mm

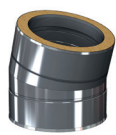

Codo 15°



Codo 30°



Codo 45°

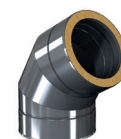

Codo 60°

Ø80	661-DWECO5450080	247€	Ø80	661-DWECO160080	119€	Ø80	661-DWECO170080	119€	Ø80	661-DWECO180080	119€	Ø80	661-DWECO840080	146€
Ø100	661-DWECO5450100	256€	Ø100	661-DWECO160100	123€	Ø100	661-DWECO170100	123€	Ø100	661-DWECO180100	123€	Ø100	661-DWECO840100	152€
Ø130	661-DWECO5450130	264€	Ø130	661-DWECO160130	132€	Ø130	661-DWECO170130	132€	Ø130	661-DWECO180130	132€	Ø130	661-DWECO840130	157€
Ø150	661-DWECO5450150	290€	Ø150	661-DWECO160150	143€	Ø150	661-DWECO170150	143€	Ø150	661-DWECO180150	143€	Ø150	661-DWECO840150	173€
Ø180	661-DWECO5450180	338€	Ø180	661-DWECO160180	169€	Ø180	661-DWECO170180	169€	Ø180	661-DWECO180180	169€	Ø180	661-DWECO840180	205€
Ø200	661-DWECO5450200	390€	Ø200	661-DWECO160200	196€	Ø200	661-DWECO170200	196€	Ø200	661-DWECO180200	196€	Ø200	661-DWECO840200	235€
Ø250	661-DWECO5450250	439€	Ø250	661-DWECO160250	220€	Ø250	661-DWECO170250	220€	Ø250	661-DWECO180250	220€	Ø250	661-DWECO840250	269€
Ø300	661-DWECO5450300	524€	Ø300	661-DWECO160300	287€	Ø300	661-DWECO170300	287€	Ø300	661-DWECO180300	287€	Ø300	661-DWECO840300	351€
Ø350	661-DWECO5450350	699€	Ø350	661-DWECO160350	361€	Ø350	661-DWECO170350	361€	Ø350	661-DWECO180350	361€	Ø350	661-DWECO840350	406€
Ø400	661-DWECO5450400	871€	Ø400	661-DWECO160400	447€	Ø400	661-DWECO170400	447€	Ø400	661-DWECO180400	447€			
Ø450	661-DWECO5450450	887€	Ø450	661-DWECO160450	652€	Ø450	661-DWECO170450	652€	Ø450	661-DWECO180450	652€			
Ø500	661-DWECO5450500	931€	Ø500	661-DWECO160500	724€	Ø500	661-DWECO170500	724€	Ø500	661-DWECO180500	724€			
Ø550	661-DWECO5450550	961€	Ø550	661-DWECO160550	1015€	Ø550	661-DWECO170550	1015€	Ø550	661-DWECO180550	1015€			
Ø600	661-DWECO5450600	1172€	Ø600	661-DWECO160600	1198€	Ø600	661-DWECO170600	1198€	Ø600	661-DWECO180600	1198€			
Ø650	661-DWECO5450650	1533€	Ø650	661-DWECO160650	1565€	Ø650	661-DWECO170650	1565€	Ø650	661-DWECO180650	1565€			
Ø700	661-DWECO5450700	1625€	Ø700	661-DWECO160700	1655€	Ø700	661-DWECO170700	1655€	Ø700	661-DWECO180700	1655€			
Ø750	661-DWECO5450750	1721€	Ø750	661-DWECO160750	1756€	Ø750	661-DWECO170750	1756€	Ø750	661-DWECO180750	1756€			
Ø800	661-DWECO5450800	1914€	Ø800	661-DWECO160800	1948€	Ø800	661-DWECO170800	1948€	Ø800	661-DWECO180800	1948€			



# CHIMENEA INDIVIDUAL

## Sistema DW - ECO 2.0 316

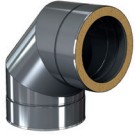

Codo 87°

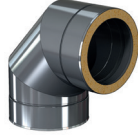

Codo 90°

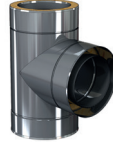

Te 87°

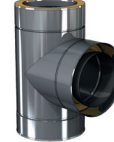

Te 90°



Te 135°

Ø80	661-DWECO640080	169€	Ø80	661-DWECO600080	169€	Ø80	661-DWECO110080	289€	Ø80	661-DWECO3170080	245€	Ø80	661-DWECO120080	352€
Ø100	661-DWECO640100	178€	Ø100	661-DWECO600100	178€	Ø100	661-DWECO110100	300€	Ø100	661-DWECO3170100	254€	Ø100	661-DWECO120100	365€
Ø130	661-DWECO640130	183€	Ø130	661-DWECO600130	183€	Ø130	661-DWECO110130	306€	Ø130	661-DWECO3170130	266€	Ø130	661-DWECO120130	369€
Ø150	661-DWECO640150	205€	Ø150	661-DWECO600150	205€	Ø150	661-DWECO110150	341€	Ø150	661-DWECO3170150	286€	Ø150	661-DWECO120150	413€
Ø180	661-DWECO640180	236€	Ø180	661-DWECO600180	236€	Ø180	661-DWECO110180	398€	Ø180	661-DWECO3170180	333€	Ø180	661-DWECO120180	479€
Ø200	661-DWECO640200	272€	Ø200	661-DWECO600200	272€	Ø200	661-DWECO110200	458€	Ø200	661-DWECO3170200	390€	Ø200	661-DWECO120200	571€
Ø250	661-DWECO640250	319€	Ø250	661-DWECO600250	319€	Ø250	661-DWECO110250	571€	Ø250	661-DWECO3170250	479€	Ø250	661-DWECO120250	694€
Ø300	661-DWECO640300	413€	Ø300	661-DWECO600300	413€	Ø300	661-DWECO110300	741€	Ø300	661-DWECO3170300	623€	Ø300	661-DWECO120300	897€
Ø350	661-DWECO640350	449€	Ø350	661-DWECO600350	449€	Ø350	661-DWECO110350	927€	Ø350	661-DWECO3170350	781€	Ø350	661-DWECO120350	1120€
Ø400	661-DWECO640400	530€	Ø400	661-DWECO600400	530€	Ø400	661-DWECO110400	1160€	Ø400	661-DWECO3170400	976€	Ø400	661-DWECO120400	1399€
						Ø450	661-DWECO110450	1315€	Ø450	661-DWECO3170450	1106€	Ø450	661-DWECO120450	1800€
						Ø500	661-DWECO110500	1549€	Ø500	661-DWECO3170500	1308€	Ø500	661-DWECO120500	1861€
						Ø550	661-DWECO110550	1687€	Ø550	661-DWECO3170550	1421€	Ø550	661-DWECO120550	3173€
						Ø600	661-DWECO110600	1958€	Ø600	661-DWECO3170600	1744€	Ø600	661-DWECO120600	3352€
						Ø650	661-DWECO110650	2555€	Ø650	661-DWECO3170650	2278€	Ø650	661-DWECO120650	4371€
						Ø700	661-DWECO110700	2707€	Ø700	661-DWECO3170700	2411€	Ø700	661-DWECO120700	4632€
						Ø750	661-DWECO110750	2871€	Ø750	661-DWECO3170750	2559€	Ø750	661-DWECO120750	4909€
						Ø800	661-DWECO110800	3184€	Ø800	661-DWECO3170800	2842€	Ø800	661-DWECO120800	5448€

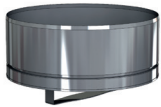

Colector de hollín

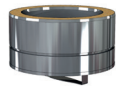

Colector de hollín aislado

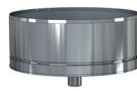

Colector de hollín con  
desagüe

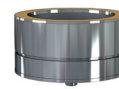

Colector de hollín con  
desagüe aislado

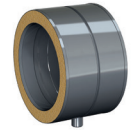

Colector de hollín con  
desagüe lateral

Ø80	661-DWECO5510080	44€	Ø80	661-DWECO20330080	71€	Ø80	661-DWECO440080	54€	Ø80	661-DWECO14600080	87€	Ø80	661-DWECO10080	127€
Ø100	661-DWECO5510100	47.13€	Ø100	661-DWECO20330100	80€	Ø100	661-DWECO440100	56€	Ø100	661-DWECO14600100	96€	Ø100	661-DWECO10100	137€
Ø130	661-DWECO5510130	61€	Ø130	661-DWECO20330130	91€	Ø130	661-DWECO440130	80€	Ø130	661-DWECO14600130	106€	Ø130	661-DWECO10130	151€
Ø150	661-DWECO5510150	67€	Ø150	661-DWECO20330150	100€	Ø150	661-DWECO440150	84€	Ø150	661-DWECO14600150	119€	Ø150	661-DWECO10150	160€
Ø180	661-DWECO5510180	76€	Ø180	661-DWECO20330180	119€	Ø180	661-DWECO440180	97€	Ø180	661-DWECO14600180	133€	Ø180	661-DWECO10180	178€
Ø200	661-DWECO5510200	84€	Ø200	661-DWECO20330200	133€	Ø200	661-DWECO440200	101€	Ø200	661-DWECO14600200	152€	Ø200	661-DWECO10200	190€
Ø250	661-DWECO5510250	91€	Ø250	661-DWECO20330250	140€	Ø250	661-DWECO440250	129€	Ø250	661-DWECO14600250	161€	Ø250	661-DWECO10250	204€
Ø300	661-DWECO5510300	109€	Ø300	661-DWECO20330300	166€	Ø300	661-DWECO440300	212€	Ø300	661-DWECO14600300	191€	Ø300	661-DWECO10300	242€
Ø350	661-DWECO5510350	140€	Ø350	661-DWECO20330350	180€	Ø350	661-DWECO440350	269€	Ø350	661-DWECO14600350	220€	Ø350	661-DWECO10350	286€
Ø400	661-DWECO5510400	190€	Ø400	661-DWECO20330400	211€	Ø400	661-DWECO440400	305€	Ø400	661-DWECO14600400	297€	Ø400	661-DWECO10400	337€
Ø450	661-DWECO5510450	205€	Ø450	661-DWECO20330450	236€	Ø450	661-DWECO440450	333€	Ø450	661-DWECO14600450	356€	Ø450	661-DWECO10450	397€
Ø500	661-DWECO5510500	274€	Ø500	661-DWECO20330500	351€	Ø500	661-DWECO440500	344€	Ø500	661-DWECO14600500	421€	Ø500	661-DWECO10500	488€
Ø550	661-DWECO5510550	290€	Ø550	661-DWECO20330550	430€	Ø550	661-DWECO440550	393€	Ø550	661-DWECO14600550	516€	Ø550	661-DWECO10550	642€
Ø600	661-DWECO5510600	300€	Ø600	661-DWECO20330600	450€	Ø600	661-DWECO440600	452€	Ø600	661-DWECO14600600	534€	Ø600	661-DWECO10600	782€
Ø650	661-DWECO5510650	341€	Ø650	661-DWECO20330650	462€	Ø650	661-DWECO440650	486€	Ø650	661-DWECO14600650	611€	Ø650	661-DWECO10650	895€
Ø700	661-DWECO5510700	367€	Ø700	661-DWECO20330700	500€	Ø700	661-DWECO440700	521€	Ø700	661-DWECO14600700	656€	Ø700	661-DWECO10700	962€
Ø750	661-DWECO5510750	393€	Ø750	661-DWECO20330750	530€	Ø750	661-DWECO440750	556€	Ø750	661-DWECO14600750	701€	Ø750	661-DWECO10750	1029€
Ø800	661-DWECO5510800	420€	Ø800	661-DWECO20330800	567€	Ø800	661-DWECO440800	567€	Ø800	661-DWECO14600800	750€	Ø800	661-DWECO10800	1101€



Codo 87° con inspección P1

Codo 90° con tapa de inspección P1

Módulo de inspección

Módulo de inspección con tapa 200 Pa (P1)

Módulo de inspección con tapa 40 Pa (N1)

Ø80	661-DWECO67AL0080	330€	Ø80	661-DWECO19AL0080	330€	Ø80	661-DWECO5430080	141€	Ø80	661-DWECO5490080	228€	Ø80	661-DWECO680080	228€
Ø100	661-DWECO67AL0100	343€	Ø100	661-DWECO19AL0100	343€	Ø100	661-DWECO5430100	150€	Ø100	661-DWECO5490100	250€	Ø100	661-DWECO680100	250€
Ø130	661-DWECO67AL0130	356€	Ø130	661-DWECO19AL0130	356€	Ø130	661-DWECO5430130	155€	Ø130	661-DWECO5490130	266€	Ø130	661-DWECO680130	266€
Ø150	661-DWECO67AL0150	364€	Ø150	661-DWECO19AL0150	364€	Ø150	661-DWECO5430150	170€	Ø150	661-DWECO5490150	272€	Ø150	661-DWECO680150	272€
Ø180	661-DWECO67AL0180	420€	Ø180	661-DWECO19AL0180	420€	Ø180	661-DWECO5430180	200€	Ø180	661-DWECO5490180	288€	Ø180	661-DWECO680180	288€
Ø200	661-DWECO67AL0200	454€	Ø200	661-DWECO19AL0200	454€	Ø200	661-DWECO5430200	227€	Ø200	661-DWECO5490200	303€	Ø200	661-DWECO680200	303€
Ø250	661-DWECO67AL0250	439€	Ø250	661-DWECO19AL0250	439€	Ø250	661-DWECO5430250	268€	Ø250	661-DWECO5490250	322€	Ø250	661-DWECO680250	322€
Ø300	661-DWECO67AL0300	504€	Ø300	661-DWECO19AL0300	504€	Ø300	661-DWECO5430300	343€	Ø300	661-DWECO5490300	351€	Ø300	661-DWECO680300	351€
Ø350	661-DWECO67AL0350	801€	Ø350	661-DWECO19AL0350	801€	Ø350	661-DWECO5430350	428€	Ø350	661-DWECO5490350	373€	Ø350	661-DWECO680350	373€
						Ø400	661-DWECO5430400	538€	Ø400	661-DWECO5490400	533€	Ø400	661-DWECO680400	533€
						Ø450	661-DWECO5430450	586€	Ø450	661-DWECO5490450	575€	Ø450	661-DWECO680450	575€
						Ø500	661-DWECO5430500	637€	Ø500	661-DWECO5490500	612€	Ø500	661-DWECO680500	612€
						Ø550	661-DWECO5430550	663€	Ø550	661-DWECO5490550	648€	Ø550	661-DWECO680550	648€
						Ø600	661-DWECO5430600	695€	Ø600	661-DWECO5490600	686€	Ø600	661-DWECO680600	686€
						Ø650	661-DWECO5430650	905€	Ø650	661-DWECO5490650	770€	Ø650	661-DWECO680650	770€
						Ø700	661-DWECO5430700	961€	Ø700	661-DWECO5490700	828€	Ø700	661-DWECO680700	828€
						Ø750	661-DWECO5430750	1019€	Ø750	661-DWECO5490750	867€	Ø750	661-DWECO680750	867€
						Ø800	661-DWECO5430800	1129€	Ø800	661-DWECO5490800	907€	Ø800	661-DWECO680800	907€

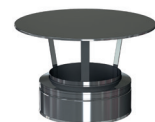
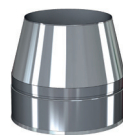
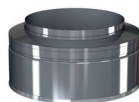

Módulo de medioambiente

Módulo temperatura humos

Terminal salida libre

Terminal salida cónica

Terminal anti-lluvia

Ø130	661-DWECO12680130	629€	Ø80	661-DWECO870080	584€	Ø80	661-DWECO320080	78€	Ø80	661-DWECO32C0080	90€	Ø80	661-DWECO5260080	107€
Ø150	661-DWECO12680150	649€	Ø100	661-DWECO870100	611€	Ø100	661-DWECO320100	80€	Ø100	661-DWECO32C0100	91€	Ø100	661-DWECO5260100	110€
Ø180	661-DWECO12680180	683€	Ø130	661-DWECO870130	606€	Ø130	661-DWECO320130	81€	Ø130	661-DWECO32C0130	95€	Ø130	661-DWECO5260130	111€
Ø200	661-DWECO12680200	714€	Ø150	661-DWECO870150	670€	Ø150	661-DWECO320150	95€	Ø150	661-DWECO32C0150	106€	Ø150	661-DWECO5260150	127€
Ø250	661-DWECO12680250	739€	Ø180	661-DWECO870180	771€	Ø180	661-DWECO320180	106€	Ø180	661-DWECO32C0180	121€	Ø180	661-DWECO5260180	146€
Ø300	661-DWECO12680300	805€	Ø200	661-DWECO870200	833€	Ø200	661-DWECO320200	122€	Ø200	661-DWECO32C0200	140€	Ø200	661-DWECO5260200	168€
Ø350	661-DWECO12680350	1295€	Ø250	661-DWECO870250	920€	Ø250	661-DWECO320250	141€	Ø250	661-DWECO32C0250	163€	Ø250	661-DWECO5260250	200€
Ø400	661-DWECO12680400	1380€	Ø300	661-DWECO870300	981€	Ø300	661-DWECO320300	184€	Ø300	661-DWECO32C0300	211€	Ø300	661-DWECO5260300	256€
Ø450	661-DWECO12680450	1446€	Ø350	661-DWECO870350	1096€	Ø350	661-DWECO320350	234€	Ø350	661-DWECO32C0350	268€	Ø350	661-DWECO5260350	322€
Ø500	661-DWECO12680500	1514€	Ø400	661-DWECO870400	1157€	Ø400	661-DWECO320400	287€	Ø400	661-DWECO32C0400	329€	Ø400	661-DWECO5260400	401€
Ø550	661-DWECO12680550	1632€	Ø450	661-DWECO870450	1255€	Ø450	661-DWECO320450	316€	Ø450	661-DWECO32C0450	363€	Ø450	661-DWECO5260450	876€
Ø600	661-DWECO12680600	1721€	Ø500	661-DWECO870500	1368€	Ø500	661-DWECO320500	341€	Ø500	661-DWECO32C0500	391€	Ø500	661-DWECO5260500	888€
Ø650	661-DWECO12680650	1865€	Ø550	661-DWECO870550	1469€	Ø550	661-DWECO320550	363€	Ø550	661-DWECO32C0550	415€	Ø550	661-DWECO5260550	1000€
Ø700	661-DWECO12680700	2007€	Ø600	661-DWECO870600	1490€	Ø600	661-DWECO320600	369€	Ø600	661-DWECO32C0600	427€	Ø600	661-DWECO5260600	1023€
Ø750	661-DWECO12680750	2152€	Ø650	661-DWECO870650	1947€	Ø650	661-DWECO320650	483€	Ø650	661-DWECO32C0650	556€			
Ø800	661-DWECO12680800	2293€	Ø700	661-DWECO870700	2062€	Ø700	661-DWECO320700	511€	Ø700	661-DWECO32C0700	591€			
			Ø750	661-DWECO870750	2189€	Ø750	661-DWECO320750	544€	Ø750	661-DWECO32C0750	625€			
			Ø800	661-DWECO870800	2430€	Ø800	661-DWECO320800	606€	Ø800	661-DWECO32C0800	698€			



# CHIMENEA INDIVIDUAL

## Sistema DW - ECO 2.0 316

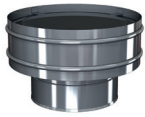

Terminal anti-viento

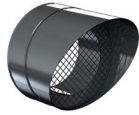

Terminal horizontal con rejilla



Terminal Gas



Terminal acelerador de biomasa



Regulador de tiro

Ø80	661-DWECO5270080	155€	Ø80	661-DWECO5320080	97€	Ø130	661-DWECO14540130	430€	Ø150	661-DWECO43560150	612€	Ø80	661-DWECO5310080	247€
Ø100	661-DWECO5270100	160€	Ø100	661-DWECO5320100	97€	Ø150	661-DWECO14540150	550€	Ø180	661-DWECO43560180	648€	Ø100	661-DWECO5310100	256€
Ø130	661-DWECO5270130	161€	Ø130	661-DWECO5320130	99€	Ø180	661-DWECO14540180	632€	Ø200	661-DWECO43560200	667€	Ø130	661-DWECO5310130	264€
Ø150	661-DWECO5270150	178€	Ø150	661-DWECO5320150	111€	Ø200	661-DWECO14540200	666€	Ø250	661-DWECO43560250	761€	Ø150	661-DWECO5310150	290€
Ø180	661-DWECO5270180	207€	Ø180	661-DWECO5320180	132€	Ø250	661-DWECO14540250	746€	Ø300	661-DWECO43560300	1046€	Ø180	661-DWECO5310180	338€
Ø200	661-DWECO5270200	241€	Ø200	661-DWECO5320200	152€	Ø300	661-DWECO14540300	976€	Ø350	661-DWECO43560350	1096€	Ø200	661-DWECO5310200	390€
Ø250	661-DWECO5270250	287€	Ø250	661-DWECO5320250	178€	Ø350	661-DWECO14540350	1088€	Ø400	661-DWECO43560400	1255€	Ø250	661-DWECO5310250	461€
Ø300	661-DWECO5270300	369€	Ø300	661-DWECO5320300	233€	Ø400	661-DWECO14540400	1317€	Ø450	661-DWECO43560450	1357€	Ø300	661-DWECO5310300	599€
Ø350	661-DWECO5270350	449€	Ø350	661-DWECO5320350	290€	Ø450	661-DWECO14540450	1671€	Ø500	661-DWECO43560500	1421€	Ø350	661-DWECO5310350	752€
Ø400	661-DWECO5270400	553€	Ø400	661-DWECO5320400	358€	Ø500	661-DWECO14540500	1873€				Ø400	661-DWECO5310400	935€
			Ø450	661-DWECO5320450	447€	Ø550	661-DWECO14540550	2073€				Ø450	661-DWECO5310450	1023€
			Ø500	661-DWECO5320500	466€	Ø600	661-DWECO14540600	2153€				Ø500	661-DWECO5310500	1114€
			Ø550	661-DWECO5320550	655€	Ø650	661-DWECO14540650	2335€				Ø550	661-DWECO5310550	1176€
			Ø600	661-DWECO5320600	736€	Ø700	661-DWECO14540700	2514€				Ø600	661-DWECO5310600	1213€
			Ø650	661-DWECO5320650	798€	Ø750	661-DWECO14540750	2691€				Ø650	661-DWECO5310650	1583€
			Ø700	661-DWECO5320700	859€	Ø800	661-DWECO14540800	2871€				Ø700	661-DWECO5310700	1676€
			Ø750	661-DWECO5320750	920€							Ø750	661-DWECO5310750	1777€
			Ø800	661-DWECO5320800	984€							Ø800	661-DWECO5310800	1975€



Estabilizador de tiro (adaptador + clapeta)



Estabilizador de tiro Premium Z250

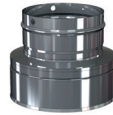

Adaptador a Hurricane

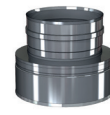

Adaptador doble a simple

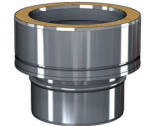

Adaptador simple a doble

Ø80	661-DWECO9700080	254€	Ø80	665-ZUWA319	2812€	Ø130	661-DWECO44760130	170€	Ø80	661-DWECO37A0080	52€	Ø80	661-DWECO370080	52€
Ø100	661-DWECO9700100	271€	Ø100	665-ZUWA319	2812€	Ø150	661-DWECO44760150	191€	Ø100	661-DWECO37A0100	61€	Ø100	661-DWECO370100	61€
Ø130	661-DWECO9700130	278€	Ø130	665-ZUWA319	2812€	Ø180	661-DWECO44760180	228€	Ø130	661-DWECO37A0130	62€	Ø130	661-DWECO370130	62€
Ø150	661-DWECO9700150	357€	Ø150	665-ZUWA319	2812€	Ø200	661-DWECO44760200	247€	Ø150	661-DWECO37A0150	71€	Ø150	661-DWECO370150	71€
Ø180	661-DWECO9700180	391€	Ø180	665-ZUWA319	2812€	Ø250	661-DWECO44760250	286€	Ø180	661-DWECO37A0180	83€	Ø180	661-DWECO370180	83€
Ø200	661-DWECO9700200	413€	Ø200	665-ZUWA319	2812€	Ø300	661-DWECO44760300	322€	Ø200	661-DWECO37A0200	97€	Ø200	661-DWECO370200	97€
Ø250	661-DWECO9700250	452€	Ø250	665-ZUWA319	2812€				Ø250	661-DWECO37A0250	106€	Ø250	661-DWECO370250	106€
Ø300	661-DWECO9700300	492€	Ø300	665-ZUWA319	2812€				Ø300	661-DWECO37A0300	137€	Ø300	661-DWECO370300	137€
Ø350	661-DWECO9700350	597€	Ø350	665-ZUWA319	2812€				Ø350	661-DWECO37A0350	169€	Ø350	661-DWECO370350	169€
Ø400	661-DWECO9700400	731€	Ø400	665-ZUWA319	2812€				Ø400	661-DWECO37A0400	211€	Ø400	661-DWECO370400	211€
Ø450	661-DWECO9700450	880€	Ø450	665-ZUWA319	2812€				Ø450	661-DWECO37A0450	227€	Ø450	661-DWECO370450	227€
Ø500	661-DWECO9700500	976€	Ø500	665-ZUWA319	2812€				Ø500	661-DWECO37A0500	250€	Ø500	661-DWECO370500	250€
Ø550	661-DWECO9700550	1026€	Ø550	665-ZUWA319	2812€				Ø550	661-DWECO37A0550	311€	Ø550	661-DWECO370550	311€
Ø600	661-DWECO9700600	1222€	Ø600	665-ZUWA319	2812€				Ø600	661-DWECO37A0600	321€	Ø600	661-DWECO370600	321€
Ø650	661-DWECO9700650	1592€	Ø650	665-ZUWA319	2812€				Ø650	661-DWECO37A0650	416€	Ø650	661-DWECO370650	416€
Ø700	661-DWECO9700700	1688€	Ø700	665-ZUWA319	2812€				Ø700	661-DWECO37A0700	441€	Ø700	661-DWECO370700	441€
Ø750	661-DWECO9700750	1790€	Ø750	665-ZUWA319	2812€				Ø750	661-DWECO37A0750	468€	Ø750	661-DWECO370750	468€
Ø800	661-DWECO9700800	1987€	Ø800	665-ZUWA319	2812€				Ø800	661-DWECO37A0800	520€	Ø800	661-DWECO370800	520€



Consultar página 91 para ver distancias de separación.

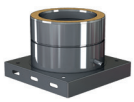

Placa base con desagüe lateral

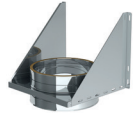

Soporte de carga regulable



Pasamuros EI



Abrazadera de unión 2.0



Abrazadera fijación pared regulable 50-80mm

Ø80	661-DWECO60080	236€	Ø80	661-DWECO3790080	211€	Ø80	661-DWECO43300080	497€	Ø80	665-ZUWA9890130	11.38€	Ø80	665-ZUWA5560130	37.43€
Ø100	661-DWECO60100	245€	Ø100	661-DWECO3790100	221€	Ø100	661-DWECO43300100	510€	Ø100	665-ZUWA9890150	11.38€	Ø100	665-ZUWA5560150	39.04€
Ø130	661-DWECO60130	247€	Ø130	661-DWECO3790130	222€	Ø130	661-DWECO43300130	537€	Ø130	665-ZUWA9890180	14.65€	Ø130	665-ZUWA5560180	39.04€
Ø150	661-DWECO60150	275€	Ø150	661-DWECO3790150	250€	Ø150	661-DWECO43300150	521€	Ø150	665-ZUWA9890200	17.9€	Ø150	665-ZUWA5560200	45.58€
Ø180	661-DWECO60180	290€	Ø180	661-DWECO3790180	295€	Ø180	661-DWECO43300180	621€	Ø180	665-ZUWA9890230	19.51€	Ø180	665-ZUWA5560230	52€
Ø200	661-DWECO60200	328€	Ø200	661-DWECO3790200	337€	Ø200	661-DWECO43300200	687€	Ø200	665-ZUWA9890250	26.04€	Ø200	665-ZUWA5560250	61€
Ø250	661-DWECO60250	363€	Ø250	661-DWECO3790250	398€	Ø250	661-DWECO43300250	782€	Ø250	665-ZUWA9890300	30.9€	Ø250	665-ZUWA5560300	64€
Ø300	661-DWECO60300	389€	Ø300	661-DWECO3790300	516€	Ø300	661-DWECO43300300	890€	Ø300	665-ZUWA9890350	34.15€	Ø300	665-ZUWA5560350	67€
Ø350	661-DWECO60350	454€	Ø350	661-DWECO3790350	647€	Ø350	661-DWECO43300350	1037€	Ø350	665-ZUWA9890400	42.42€	Ø350	665-ZUWA5560400	88€
Ø400	661-DWECO60400	555€	Ø400	661-DWECO3790400	801€	Ø400	661-DWECO43300400	1281€	Ø400	665-ZUWA9890450	48.72€	Ø400	665-ZUWA5560450	98€
Ø450	661-DWECO60450	606€	Ø450	661-DWECO3790450	872€	Ø450	661-DWECO43300450	1474€	Ø450	665-ZUWA9890500	54€			
Ø500	661-DWECO60500	658€	Ø500	661-DWECO3790500	954€	Ø500	661-DWECO43300500	1682€	Ø500	665-ZUWA9890550	58€			
Ø550	661-DWECO60550	776€	Ø550	661-DWECO3790550	1096€	Ø550	661-DWECO43300550	1792€	Ø550	665-ZUWA9890600	66€			
Ø600	661-DWECO60600	840€	Ø600	661-DWECO3790600	1217€	Ø600	661-DWECO43300600	1751€	Ø600	665-ZUWA9890650	73€			
Ø650	661-DWECO60650	1101€	Ø650	661-DWECO3790650	1589€	Ø650	661-DWECO43300650	1945€	Ø650	665-ZUWA9890715	96€			
Ø700	661-DWECO60700	1165€	Ø700	661-DWECO3790700	1686€	Ø700	661-DWECO43300700	2184€	Ø700	665-ZUWA9890765	107€			
Ø750	661-DWECO60750	1234€	Ø750	661-DWECO3790750	1785€	Ø750	661-DWECO43300750	2361€	Ø750	665-ZUWA9890815	114€			
Ø800	661-DWECO60800	1370€	Ø800	661-DWECO3790800	1982€	Ø800	661-DWECO43300800	2465€	Ø800	665-ZUWA9890865	121€			

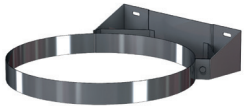

Abrazadera fijación pared fija



Base de abrazadera distanciadora



Alas distanciadoras A



Alas distanciadoras B



Alas distanciadoras C

Ø400	665-ZUWA556F0450	118€	Ø80	665-ZUWA14620130	45.58€	Ø80	665-ZUWA1462A	47.13€	Ø80	665-ZUWA1462B	65€	Ø80	665-ZUWA1462C	81€
Ø450	665-ZUWA556F0500	123€	Ø100	665-ZUWA14620150	48.72€	Ø100	665-ZUWA1462A	47.13€	Ø100	665-ZUWA1462B	65€	Ø100	665-ZUWA1462C	81€
Ø500	665-ZUWA556F0550	155€	Ø130	665-ZUWA14620180	52€	Ø130	665-ZUWA1462A	47.13€	Ø130	665-ZUWA1462B	65€	Ø130	665-ZUWA1462C	81€
Ø550	665-ZUWA556F0600	185€	Ø150	665-ZUWA14620200	58€	Ø150	665-ZUWA1462A	47.13€	Ø150	665-ZUWA1462B	65€	Ø150	665-ZUWA1462C	81€
Ø600	665-ZUWA556F0650	203€	Ø180	665-ZUWA14620230	77€	Ø180	665-ZUWA1462A	47.13€	Ø180	665-ZUWA1462B	65€	Ø180	665-ZUWA1462C	81€
Ø650	665-ZUWA556F0715	290€	Ø200	665-ZUWA14620250	100€	Ø200	665-ZUWA1462A	47.13€	Ø200	665-ZUWA1462B	65€	Ø200	665-ZUWA1462C	81€
Ø700	665-ZUWA556F0765	337€	Ø250	665-ZUWA14620300	138€	Ø250	665-ZUWA1462A	47.13€	Ø250	665-ZUWA1462B	65€	Ø250	665-ZUWA1462C	81€
Ø750	665-ZUWA556F0815	367€	Ø300	665-ZUWA14620350	185€	Ø300	665-ZUWA1462A	47.13€	Ø300	665-ZUWA1462B	65€	Ø300	665-ZUWA1462C	81€
Ø800	665-ZUWA556F0865	387€	Ø350	665-ZUWA14620400	241€	Ø350	665-ZUWA1462A	47.13€	Ø350	665-ZUWA1462B	65€	Ø350	665-ZUWA1462C	81€
			Ø400	665-ZUWA14620450	298€	Ø400	665-ZUWA1462A	47.13€	Ø400	665-ZUWA1462B	65€	Ø400	665-ZUWA1462C	81€
			Ø450	665-ZUWA14620500	328€	Ø450	665-ZUWA1462A	47.13€	Ø450	665-ZUWA1462B	65€	Ø450	665-ZUWA1462C	81€
			Ø500	665-ZUWA14620550	365€	Ø500	665-ZUWA1462A	47.13€	Ø500	665-ZUWA1462B	65€	Ø500	665-ZUWA1462C	81€
			Ø550	665-ZUWA14620600	412€	Ø550	665-ZUWA1462A	47.13€	Ø550	665-ZUWA1462B	65€	Ø550	665-ZUWA1462C	81€
			Ø600	665-ZUWA14620650	444€	Ø600	665-ZUWA1462A	47.13€	Ø600	665-ZUWA1462B	65€	Ø600	665-ZUWA1462C	81€
			Ø650	665-ZUWA14620715	580€	Ø650	665-ZUWA1462A	47.13€	Ø650	665-ZUWA1462B	65€	Ø650	665-ZUWA1462C	81€
			Ø700	665-ZUWA14620765	688€	Ø700	665-ZUWA1462A	47.13€	Ø700	665-ZUWA1462B	65€	Ø700	665-ZUWA1462C	81€
			Ø750	665-ZUWA14620815	812€	Ø750	665-ZUWA1462A	47.13€	Ø750	665-ZUWA1462B	65€	Ø750	665-ZUWA1462C	81€
			Ø800	665-ZUWA14620865	850€	Ø800	665-ZUWA1462A	47.13€	Ø800	665-ZUWA1462B	65€	Ø800	665-ZUWA1462C	81€



# CHIMENEA INDIVIDUAL

## Sistema DW - ECO 2.0 316



Alas distanciadoras D

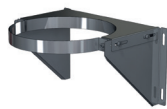

Abrazadera de soporte



Abrazadera con doble pértiga telescópica L=2000mm



Abrazadera fijacion a techo

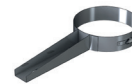

Abrazadera forjado inox

Ø80	665-ZUWA1462D	104€	Ø130	665-ZUWA8580180	145€	Ø80	665-ZUWA1910130	144€	Ø80	665-ZUWA118B0130	39.04€	Ø80	665-ZUWA620130	26.04€
Ø100	665-ZUWA1462D	104€	Ø150	665-ZUWA8580200	145€	Ø100	665-ZUWA1910150	146€	Ø100	665-ZUWA118B0150	42.42€	Ø100	665-ZUWA620150	30.9€
Ø130	665-ZUWA1462D	104€	Ø180	665-ZUWA8580230	163€	Ø130	665-ZUWA1910180	156€	Ø130	665-ZUWA118B0180	48.72€	Ø130	665-ZUWA620180	42.42€
Ø150	665-ZUWA1462D	104€	Ø200	665-ZUWA8580250	185€	Ø150	665-ZUWA1910200	173€	Ø150	665-ZUWA118B0200	59€	Ø150	665-ZUWA620200	47.13€
Ø180	665-ZUWA1462D	104€	Ø250	665-ZUWA8580300	203€	Ø180	665-ZUWA1910230	179€	Ø180	665-ZUWA118B0230	66€	Ø180	665-ZUWA620230	50€
Ø200	665-ZUWA1462D	104€	Ø300	665-ZUWA8580350	221€	Ø200	665-ZUWA1910250	196€	Ø200	665-ZUWA118B0250	66€	Ø200	665-ZUWA620250	50€
Ø250	665-ZUWA1462D	104€	Ø350	665-ZUWA8580400	270€	Ø250	665-ZUWA1910300	233€	Ø250	665-ZUWA118B0300	88€	Ø250	665-ZUWA620300	59€
Ø300	665-ZUWA1462D	104€	Ø400	665-ZUWA8580450	321€	Ø300	665-ZUWA1910350	249€	Ø300	665-ZUWA118B0350	100€	Ø300	665-ZUWA620350	66€
Ø350	665-ZUWA1462D	104€	Ø450	665-ZUWA8580500	354€	Ø350	665-ZUWA1910400	272€				Ø350	665-ZUWA620400	74€
Ø400	665-ZUWA1462D	104€	Ø500	665-ZUWA8580550	401€	Ø400	665-ZUWA1910450	380€				Ø400	665-ZUWA620450	83€
Ø450	665-ZUWA1462D	104€	Ø550	665-ZUWA8580600	454€	Ø450	665-ZUWA1910500	496€				Ø450	665-ZUWA620500	96€
Ø500	665-ZUWA1462D	104€	Ø600	665-ZUWA8580650	492€	Ø500	665-ZUWA1910550	647€				Ø500	665-ZUWA620550	103€
Ø550	665-ZUWA1462D	104€	Ø650	665-ZUWA8580715	706€	Ø550	665-ZUWA1910600	699€				Ø550	665-ZUWA620600	109€
Ø600	665-ZUWA1462D	104€	Ø700	665-ZUWA8580765	825€	Ø600	665-ZUWA1910650	766€				Ø600	665-ZUWA620650	115€
Ø650	665-ZUWA1462D	104€	Ø750	665-ZUWA8580815	899€	Ø650	665-ZUWA1910715	930€						
Ø700	665-ZUWA1462D	104€	Ø800	665-ZUWA8580865	943€	Ø700	665-ZUWA1910765	1055€						
Ø750	665-ZUWA1462D	104€				Ø750	665-ZUWA1910815	1164€						
Ø800	665-ZUWA1462D	104€				Ø800	665-ZUWA1910865	1222€						



Abrazadera para amarre por tornillo



Abrazadera vientos



Soporte de techo



Collarín antitormenta

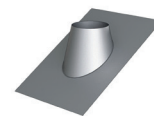

Cubreguas 25°-45° aluminio

Ø80	665-ZUWA10630130	32.52€	Ø80	665-ZUWA420130	11.38€	Ø80	665-ZUWA9360130	34.15€	Ø80	665-ZUWA3070130	29.27€	Ø80	665-ZUWA939AL0130	219€
Ø100	665-ZUWA10630150	35.77€	Ø100	665-ZUWA420150	14.65€	Ø100	665-ZUWA9360150	40.87€	Ø100	665-ZUWA3070150	34.15€	Ø100	665-ZUWA939AL0150	233€
Ø130	665-ZUWA10630180	39.04€	Ø130	665-ZUWA420180	21.16€	Ø130	665-ZUWA9360180	50€	Ø130	665-ZUWA3070180	40.87€	Ø130	665-ZUWA939AL0180	250€
Ø150	665-ZUWA10630200	42.42€	Ø150	665-ZUWA420200	26.04€	Ø150	665-ZUWA9360200	56€	Ø150	665-ZUWA3070200	47.13€	Ø150	665-ZUWA939AL0200	269€
Ø180	665-ZUWA10630230	50€	Ø180	665-ZUWA420230	27.67€	Ø180	665-ZUWA9360230	65€	Ø180	665-ZUWA3070230	52€	Ø180	665-ZUWA939AL0230	288€
Ø200	665-ZUWA10630250	50€	Ø200	665-ZUWA420250	29.27€	Ø200	665-ZUWA9360250	73€	Ø200	665-ZUWA3070250	59€	Ø200	665-ZUWA939AL0250	305€
Ø250	665-ZUWA10630300	65€	Ø250	665-ZUWA420300	34.15€	Ø250	665-ZUWA9360300	84€	Ø250	665-ZUWA3070300	71€	Ø250	665-ZUWA939AL0300	332€
Ø300	665-ZUWA10630350	74€	Ø300	665-ZUWA420350	37.43€	Ø300	665-ZUWA9360350	95€	Ø300	665-ZUWA3070350	77€	Ø300	665-ZUWA939AL0350	387€
Ø350	665-ZUWA10630400	84€	Ø350	665-ZUWA420400	40.87€	Ø350	665-ZUWA9360400	104€	Ø350	665-ZUWA3070400	83€	Ø350	665-ZUWA939AL0400	433€
Ø400	665-ZUWA10630450	97€	Ø400	665-ZUWA420450	56€	Ø400	665-ZUWA9360450	144€	Ø400	665-ZUWA3070450	114€	Ø400	665-ZUWA939AL0450	492€
Ø450	665-ZUWA10630500	106€	Ø450	665-ZUWA420500	74€	Ø450	665-ZUWA9360500	186€	Ø450	665-ZUWA3070500	151€	Ø450	665-ZUWA939AL0500	549€
Ø500	665-ZUWA10630550	114€	Ø500	665-ZUWA420550	98€	Ø500	665-ZUWA9360550	241€	Ø500	665-ZUWA3070550	199€	Ø500	665-ZUWA939AL0550	607€
Ø550	665-ZUWA10630600	129€	Ø550	665-ZUWA420600	106€	Ø550	665-ZUWA9360600	264€	Ø550	665-ZUWA3070600	211€	Ø550	665-ZUWA939AL0600	661€
Ø600	665-ZUWA10630650	139€	Ø600	665-ZUWA420650	114€	Ø600	665-ZUWA9360650	286€	Ø600	665-ZUWA3070650	234€	Ø600	665-ZUWA939AL0650	730€
Ø650	665-ZUWA10630715	157€	Ø650	665-ZUWA420715	168€	Ø650	665-ZUWA9360715	351€	Ø650	665-ZUWA3070715	283€	Ø650	665-ZUWA939AL0715	852€
Ø700	665-ZUWA10630765	173€	Ø700	665-ZUWA420765	196€	Ø700	665-ZUWA9360765	397€	Ø700	665-ZUWA3070765	321€	Ø700	665-ZUWA939AL0765	950€
Ø750	665-ZUWA10630815	185€	Ø750	665-ZUWA420815	210€	Ø750	665-ZUWA9360815	437€	Ø750	665-ZUWA3070815	356€	Ø750	665-ZUWA939AL0815	1192€
Ø800	665-ZUWA10630865	191€	Ø800	665-ZUWA420865	220€	Ø800	665-ZUWA9360865	456€	Ø800	665-ZUWA3070865	369€	Ø800	665-ZUWA939AL0865	1297€

- Precio unidad. u./c= unidad caja.
- Necesario instalar collarín con el cubreaguas.
- Consultar página 91 para ver distancias de separación.

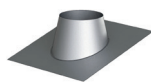

Cubreaguas 5°-25° aluminio

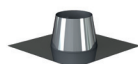

Cubreaguas plano inox

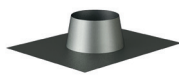

Cubreaguas plomo 0°-5°

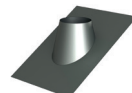

Cubreaguas plomo 25°-45°

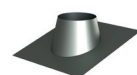

Cubreaguas plomo 5°-25°

Ø80	665-ZUWA938AL0130	206€	Ø80	665-ZUWA11280130	146€	Ø80	665-ZUWA9370130	205€	Ø80	665-ZUWA9390130	358€	Ø80	665-ZUWA9380130	205€
Ø100	665-ZUWA938AL0150	215€	Ø100	665-ZUWA11280150	150€	Ø100	665-ZUWA9370150	206€	Ø100	665-ZUWA9390150	363€	Ø100	665-ZUWA9380150	206€
Ø130	665-ZUWA938AL0180	235€	Ø130	665-ZUWA11280180	170€	Ø130	665-ZUWA9370180	234€	Ø130	665-ZUWA9390180	379€	Ø130	665-ZUWA9380180	234€
Ø150	665-ZUWA938AL0200	252€	Ø150	665-ZUWA11280200	185€	Ø150	665-ZUWA9370200	260€	Ø150	665-ZUWA9390200	386€	Ø150	665-ZUWA9380200	260€
Ø180	665-ZUWA938AL0230	261€	Ø180	665-ZUWA11280230	191€	Ø180	665-ZUWA9370230	269€	Ø180	665-ZUWA9390230	397€	Ø180	665-ZUWA9380230	269€
Ø200	665-ZUWA938AL0250	282€	Ø200	665-ZUWA11280250	211€	Ø200	665-ZUWA9370250	294€	Ø200	665-ZUWA9390250	401€	Ø200	665-ZUWA9380250	294€
Ø250	665-ZUWA938AL0300	317€	Ø250	665-ZUWA11280300	233€	Ø250	665-ZUWA9370300	323€	Ø250	665-ZUWA9390300	417€	Ø250	665-ZUWA9380300	323€
Ø300	665-ZUWA938AL0350	351€	Ø300	665-ZUWA11280350	260€	Ø300	665-ZUWA9370350	361€	Ø300	665-ZUWA9390350	431€	Ø300	665-ZUWA9380350	361€
Ø350	665-ZUWA938AL0400	390€	Ø350	665-ZUWA11280400	286€	Ø350	665-ZUWA9370400	396€	Ø350	665-ZUWA9390400	454€	Ø350	665-ZUWA9380400	396€
Ø400	665-ZUWA938AL0450	436€	Ø400	665-ZUWA11280450	306€	Ø400	665-ZUWA9370450	428€	Ø400	665-ZUWA9390450	541€	Ø400	665-ZUWA9380450	428€
Ø450	665-ZUWA938AL0500	488€	Ø450	665-ZUWA11280500	352€	Ø450	665-ZUWA9370500	488€	Ø450	665-ZUWA9390500	618€	Ø450	665-ZUWA9380500	488€
Ø500	665-ZUWA938AL0550	524€	Ø500	665-ZUWA11280550	389€	Ø500	665-ZUWA9370550	539€	Ø500	665-ZUWA9390550	691€	Ø500	665-ZUWA9380550	539€
Ø550	665-ZUWA938AL0600	573€	Ø550	665-ZUWA11280600	437€	Ø550	665-ZUWA9370600	606€	Ø550	665-ZUWA9390600	775€	Ø550	665-ZUWA9380600	606€
Ø600	665-ZUWA938AL0650	618€	Ø600	665-ZUWA11280650	492€	Ø600	665-ZUWA9370650	684€	Ø600	665-ZUWA9390650	869€	Ø600	665-ZUWA9380650	684€
Ø650	665-ZUWA938AL0715	684€	Ø650	665-ZUWA11280715	570€	Ø650	665-ZUWA9370715	789€	Ø650	665-ZUWA9390715	1006€	Ø650	665-ZUWA9380715	789€
Ø700	665-ZUWA938AL0765	785€	Ø700	665-ZUWA11280765	598€	Ø700	665-ZUWA9370765	832€	Ø700	665-ZUWA9390765	1057€	Ø700	665-ZUWA9380765	832€
Ø750	665-ZUWA938AL0815	918€	Ø750	665-ZUWA11280815	633€	Ø750	665-ZUWA9370815	880€	Ø750	665-ZUWA9390815	1115€	Ø750	665-ZUWA9380815	880€
Ø800	665-ZUWA938AL0865	1055€	Ø800	665-ZUWA11280865	662€	Ø800	665-ZUWA9370865	920€	Ø800	665-ZUWA9390865	1168€	Ø800	665-ZUWA9380865	920€



Pasamuros



Soporte cubierta ventilado



Junta de silicona (T<200°C)



Junta EPDM (T<120°C)

Ø80	665-ZUWA9870130	39.04€	Ø80	665-ZUWA9340130	64€	Ø80	665-ZUWA260080	4.88€	Ø80	665-ZUWA26C0080	4.88€
Ø100	665-ZUWA9870150	40.87€	Ø100	665-ZUWA9340150	67€	Ø100	665-ZUWA260100	4.88€	Ø100	665-ZUWA26C0100	4.88€
Ø130	665-ZUWA9870180	52€	Ø130	665-ZUWA9340180	71€	Ø130	665-ZUWA260130	4.88€	Ø130	665-ZUWA26C0130	4.88€
Ø150	665-ZUWA9870200	52€	Ø150	665-ZUWA9340200	78€	Ø150	665-ZUWA260150	4.88€	Ø150	665-ZUWA26C0150	4.88€
Ø180	665-ZUWA9870230	64€	Ø180	665-ZUWA9340230	95€	Ø180	665-ZUWA260180	6.52€	Ø180	665-ZUWA26C0180	6.52€
Ø200	665-ZUWA9870250	65€	Ø200	665-ZUWA9340250	107€	Ø200	665-ZUWA260200	8.15€	Ø200	665-ZUWA26C0200	8.15€
Ø250	665-ZUWA9870300	83€	Ø250	665-ZUWA9340300	119€	Ø250	665-ZUWA260250	11.38€	Ø250	665-ZUWA26C0250	11.38€
Ø300	665-ZUWA9870350	95€				Ø300	665-ZUWA260300	14.65€	Ø300	665-ZUWA26C0300	14.65€
Ø350	665-ZUWA9870400	121€				Ø350	665-ZUWA260350	17.9€	Ø350	665-ZUWA26C0350	17.9€
Ø400	665-ZUWA9870450	156€				Ø400	665-ZUWA260400	19.51€	Ø400	665-ZUWA26C0400	19.51€
Ø450	665-ZUWA9870500	204€				Ø450	665-ZUWA260450	21.16€	Ø450	665-ZUWA26C0450	21.16€
Ø500	665-ZUWA9870550	221€				Ø500	665-ZUWA260500	24.4€	Ø500	665-ZUWA26C0500	24.4€
Ø550	665-ZUWA9870600	244€				Ø550	665-ZUWA260550	27.67€	Ø550	665-ZUWA26C0550	27.67€
Ø600	665-ZUWA9870650	271€				Ø600	665-ZUWA260600	30.9€	Ø600	665-ZUWA26C0600	30.9€
Ø650	665-ZUWA9870715	367€				Ø650	665-ZUWA260650	35.77€	Ø650	665-ZUWA26C0650	35.77€
Ø700	665-ZUWA9870765	433€				Ø700	665-ZUWA260700	40.87€	Ø700	665-ZUWA26C0700	40.87€
Ø750	665-ZUWA9870815	483€				Ø750	665-ZUWA260750	45.58€	Ø750	665-ZUWA26C0750	45.58€
Ø800	665-ZUWA9870865	504€				Ø800	665-ZUWA260800	48.72€	Ø800	665-ZUWA26C0800	48.72€



# CHIMENEA INDIVIDUAL

## Sistema DW - ECO 2.0 316

### ADAPTADOR CALDERA HEMBRA

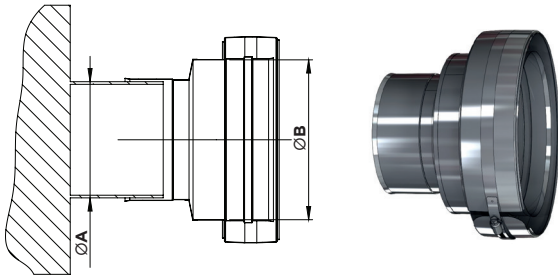

CÓDIGO	Ø A	Ø B	€
661-DWECO37H00800080	Ø80	Ø80	62€
661-DWECO37H00800100	Ø80	Ø100	90€
661-DWECO37H00800130	Ø80	Ø130	90€
661-DWECO37H01000080	Ø100	Ø80	90€
661-DWECO37H01000100	Ø100	Ø100	65€
661-DWECO37H01000130	Ø100	Ø130	91€
661-DWECO37H01000150	Ø100	Ø150	101€
661-DWECO37H01100080	Ø110	Ø80	95€
661-DWECO37H01100100	Ø110	Ø100	96€
661-DWECO37H01100130	Ø110	Ø130	91€
661-DWECO37H01100150	Ø110	Ø150	101€
661-DWECO37H01200080	Ø120	Ø80	96€
661-DWECO37H01200100	Ø120	Ø100	96€
661-DWECO37H01200130	Ø120	Ø130	91€
661-DWECO37H01200150	Ø120	Ø150	101€
661-DWECO37H01250080	Ø125	Ø80	96€
661-DWECO37H01250100	Ø125	Ø100	96€
661-DWECO37H01250130	Ø125	Ø130	65€
661-DWECO37H01250150	Ø125	Ø150	101€
661-DWECO37H01300080	Ø130	Ø80	96€
661-DWECO37H01300100	Ø130	Ø100	96€
661-DWECO37H01300130	Ø130	Ø130	65€
661-DWECO37H01300150	Ø130	Ø150	106€
661-DWECO37H01300180	Ø130	Ø180	107€
661-DWECO37H01350130	Ø135	Ø130	65€
661-DWECO37H01350150	Ø135	Ø150	106€
661-DWECO37H01350180	Ø135	Ø180	107€
661-DWECO37H01400130	Ø140	Ø130	101€
661-DWECO37H01400150	Ø140	Ø150	61€
661-DWECO37H01400180	Ø140	Ø180	73€
661-DWECO37H01500130	Ø150	Ø130	101€
661-DWECO37H01500150	Ø150	Ø150	61€
661-DWECO37H01500180	Ø150	Ø180	73€
661-DWECO37H01500200	Ø150	Ø200	146€
661-DWECO37H01600130	Ø160	Ø130	112€
661-DWECO37H01600150	Ø160	Ø150	61€
661-DWECO37H01600180	Ø160	Ø180	73€
661-DWECO37H01600200	Ø160	Ø200	146€
661-DWECO37H01750130	Ø175	Ø130	112€
661-DWECO37H01750150	Ø175	Ø150	100€
661-DWECO37H01750180	Ø175	Ø180	84€
661-DWECO37H01750200	Ø175	Ø200	146€
661-DWECO37H01800130	Ø180	Ø130	112€
661-DWECO37H01800150	Ø180	Ø150	100€
661-DWECO37H01800180	Ø180	Ø180	84€
661-DWECO37H01800200	Ø180	Ø200	150€

661-DWECO37H01800250	Ø180	Ø250	163€
661-DWECO37H02000150	Ø200	Ø150	109€
661-DWECO37H02000180	Ø200	Ø180	140€
661-DWECO37H02000200	Ø200	Ø200	97€
661-DWECO37H02000250	Ø200	Ø250	166€
661-DWECO37H02000300	Ø200	Ø300	221€
661-DWECO37H02250180	Ø225	Ø180	140€
661-DWECO37H02250200	Ø225	Ø200	155€
661-DWECO37H02250250	Ø225	Ø250	166€
661-DWECO37H02250300	Ø225	Ø300	226€
661-DWECO37H02500180	Ø250	Ø180	140€
661-DWECO37H02500200	Ø250	Ø200	155€
661-DWECO37H02500250	Ø250	Ø250	112€
661-DWECO37H02500300	Ø250	Ø300	226€
661-DWECO37H02500350	Ø250	Ø350	268€
661-DWECO37H03000250	Ø300	Ø250	202€
661-DWECO37H03000300	Ø300	Ø300	146€
661-DWECO37H03000350	Ø300	Ø350	271€
661-DWECO37H03000400	Ø300	Ø400	321€
661-DWECO37H03500250	Ø350	Ø250	220€
661-DWECO37H03500300	Ø350	Ø300	250€
661-DWECO37H03500350	Ø350	Ø350	184€
661-DWECO37H03500400	Ø350	Ø400	328€
661-DWECO37H03500450	Ø350	Ø450	368€
661-DWECO37H04000300	Ø400	Ø300	271€
661-DWECO37H04000350	Ø400	Ø350	300€
661-DWECO37H04000400	Ø400	Ø400	227€
661-DWECO37H04000450	Ø400	Ø450	369€
661-DWECO37H04000500	Ø400	Ø500	398€
661-DWECO37H04500350	Ø450	Ø350	370€
661-DWECO37H04500400	Ø450	Ø400	393€
661-DWECO37H04500450	Ø450	Ø450	247€
661-DWECO37H04500500	Ø450	Ø500	406€
661-DWECO37H04500550	Ø450	Ø550	541€
661-DWECO37H05000400	Ø500	Ø400	398€
661-DWECO37H05000450	Ø500	Ø450	380€
661-DWECO37H05000500	Ø500	Ø500	269€
661-DWECO37H05000550	Ø500	Ø550	544€
661-DWECO37H05000600	Ø500	Ø600	550€
661-DWECO37H05500450	Ø550	Ø450	474€
661-DWECO37H05500500	Ø550	Ø500	505€
661-DWECO37H05500550	Ø550	Ø550	335€
661-DWECO37H05500600	Ø550	Ø600	552€
661-DWECO37H05500650	Ø550	Ø650	592€
661-DWECO37H06000500	Ø600	Ø500	520€
661-DWECO37H06000550	Ø600	Ø550	562€
661-DWECO37H06000600	Ø600	Ø600	344€
661-DWECO37H06000650	Ø600	Ø650	597€
661-DWECO37H06000700	Ø600	Ø700	636€
661-DWECO37H06500650	Ø650	Ø650	370€
661-DWECO37H06500700	Ø650	Ø700	647€
661-DWECO37H06500750	Ø650	Ø750	682€
661-DWECO37H07000700	Ø700	Ø700	401€
661-DWECO37H07000750	Ø700	Ø750	694€
661-DWECO37H07000800	Ø700	Ø800	728€
661-DWECO37H07500750	Ø750	Ø750	428€
661-DWECO37H07500800	Ø750	Ø800	737€
661-DWECO37H08000800	Ø800	Ø800	457€

## ADAPTADOR CALDERA MACHO

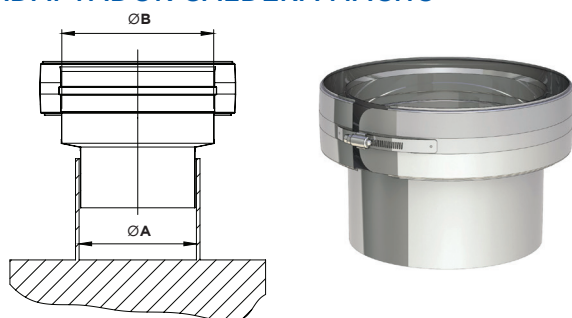

CÓDIGO	Ø A	Ø B	€
661-DWECO37M00800080	Ø80	Ø80	62€
661-DWECO37M00800100	Ø80	Ø100	90€
661-DWECO37M00800130	Ø80	Ø130	90€
661-DWECO37M01000080	Ø100	Ø80	90€
661-DWECO37M01000100	Ø100	Ø100	65€
661-DWECO37M01000130	Ø100	Ø130	91€
661-DWECO37M01000150	Ø100	Ø150	101€
661-DWECO37M01100080	Ø110	Ø80	95€
661-DWECO37M01100100	Ø110	Ø100	96€
661-DWECO37M01100130	Ø110	Ø130	91€
661-DWECO37M01100150	Ø110	Ø150	101€
661-DWECO37M01200080	Ø120	Ø80	96€
661-DWECO37M01200100	Ø120	Ø100	96€
661-DWECO37M01200130	Ø120	Ø130	91€
661-DWECO37M01200150	Ø120	Ø150	101€
661-DWECO37M01250080	Ø125	Ø80	96€
661-DWECO37M01250100	Ø125	Ø100	96€
661-DWECO37M01250130	Ø125	Ø130	65€
661-DWECO37M01250150	Ø125	Ø150	101€
661-DWECO37M01300080	Ø130	Ø80	96€
661-DWECO37M01300100	Ø130	Ø100	96€
661-DWECO37M01300130	Ø130	Ø130	65€
661-DWECO37M01300150	Ø130	Ø150	106€
661-DWECO37M01300180	Ø130	Ø180	107€
661-DWECO37M01350130	Ø135	Ø130	65€
661-DWECO37M01350150	Ø135	Ø150	106€
661-DWECO37M01350180	Ø135	Ø180	107€
661-DWECO37M01400130	Ø140	Ø130	101€
661-DWECO37M01400150	Ø140	Ø150	61€
661-DWECO37M01400180	Ø140	Ø180	73€
661-DWECO37M01500130	Ø150	Ø130	101€
661-DWECO37M01500150	Ø150	Ø150	61€
661-DWECO37M01500180	Ø150	Ø180	73€
661-DWECO37M01500200	Ø150	Ø200	146€
661-DWECO37M01600130	Ø160	Ø130	112€
661-DWECO37M01600150	Ø160	Ø150	61€
661-DWECO37M01600180	Ø160	Ø180	73€
661-DWECO37M01600200	Ø160	Ø200	146€
661-DWECO37M01750130	Ø175	Ø130	112€
661-DWECO37M01750150	Ø175	Ø150	100€
661-DWECO37M01750180	Ø175	Ø180	84€
661-DWECO37M01750200	Ø175	Ø200	146€
661-DWECO37M01800130	Ø180	Ø130	112€
661-DWECO37M01800150	Ø180	Ø150	100€
661-DWECO37M01800180	Ø180	Ø180	84€
661-DWECO37M01800200	Ø180	Ø200	150€

661-DWECO37M01800250	Ø180	Ø250	163€
661-DWECO37M02000150	Ø200	Ø150	109€
661-DWECO37M02000180	Ø200	Ø180	140€
661-DWECO37M02000200	Ø200	Ø200	97€
661-DWECO37M02000250	Ø200	Ø250	166€
661-DWECO37M02000300	Ø200	Ø300	221€
661-DWECO37M02250180	Ø225	Ø180	140€
661-DWECO37M02250200	Ø225	Ø200	155€
661-DWECO37M02250250	Ø225	Ø250	166€
661-DWECO37M02250300	Ø225	Ø300	226€
661-DWECO37M02500180	Ø250	Ø180	140€
661-DWECO37M02500200	Ø250	Ø200	155€
661-DWECO37M02500250	Ø250	Ø250	112€
661-DWECO37M02500300	Ø250	Ø300	226€
661-DWECO37M02500350	Ø250	Ø350	268€
661-DWECO37M03000250	Ø300	Ø250	202€
661-DWECO37M03000300	Ø300	Ø300	146€
661-DWECO37M03000350	Ø300	Ø350	271€
661-DWECO37M03000400	Ø300	Ø400	321€
661-DWECO37M03500250	Ø350	Ø250	220€
661-DWECO37M03500300	Ø350	Ø300	250€
661-DWECO37M03500350	Ø350	Ø350	184€
661-DWECO37M03500400	Ø350	Ø400	328€
661-DWECO37M03500450	Ø350	Ø450	368€
661-DWECO37M04000300	Ø400	Ø300	271€
661-DWECO37M04000350	Ø400	Ø350	300€
661-DWECO37M04000400	Ø400	Ø400	227€
661-DWECO37M04000450	Ø400	Ø450	369€
661-DWECO37M04000500	Ø400	Ø500	398€
661-DWECO37M04500350	Ø450	Ø350	370€
661-DWECO37M04500400	Ø450	Ø400	393€
661-DWECO37M04500450	Ø450	Ø450	247€
661-DWECO37M04500500	Ø450	Ø500	406€
661-DWECO37M04500550	Ø450	Ø550	541€
661-DWECO37M05000400	Ø500	Ø400	398€
661-DWECO37M05000450	Ø500	Ø450	380€
661-DWECO37M05000500	Ø500	Ø500	269€
661-DWECO37M05000550	Ø500	Ø550	544€
661-DWECO37M05000600	Ø500	Ø600	550€
661-DWECO37M05500450	Ø550	Ø450	474€
661-DWECO37M05500500	Ø550	Ø500	505€
661-DWECO37M05500550	Ø550	Ø550	335€
661-DWECO37M05500600	Ø550	Ø600	552€
661-DWECO37M05500650	Ø550	Ø650	592€
661-DWECO37M06000500	Ø600	Ø500	520€
661-DWECO37M06000550	Ø600	Ø550	562€
661-DWECO37M06000600	Ø600	Ø600	344€
661-DWECO37M06000650	Ø600	Ø650	597€
661-DWECO37M06000700	Ø600	Ø700	636€
661-DWECO37M06500650	Ø650	Ø650	370€
661-DWECO37M06500700	Ø650	Ø700	647€
661-DWECO37M06500750	Ø650	Ø750	682€
661-DWECO37M07000700	Ø700	Ø700	401€
661-DWECO37M07000750	Ø700	Ø750	694€
661-DWECO37M07000800	Ø700	Ø800	728€
661-DWECO37M07500750	Ø750	Ø750	428€
661-DWECO37M07500800	Ø750	Ø800	737€
661-DWECO37M08000800	Ø800	Ø800	457€



# CHIMENEA INDIVIDUAL

## Sistema DW - ECO 2.0 316

### AMPLIACIONES

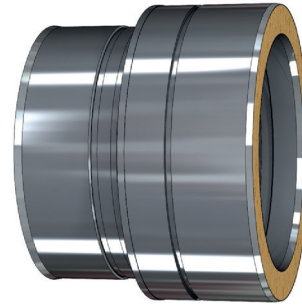
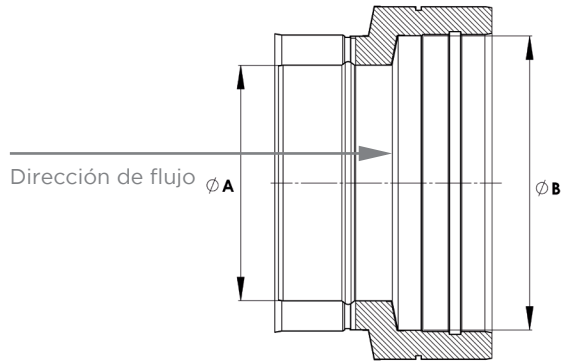

CÓDIGO	$\varnothing A$	$\varnothing B$	€
661-DWECO A00800100	Ø80	Ø100	138€
661-DWECO A00800130	Ø80	Ø130	199€
661-DWECO A00800150	Ø80	Ø150	239€
661-DWECO A00800180	Ø80	Ø180	290€
661-DWECO A00800200	Ø80	Ø200	329€
661-DWECO A01000130	Ø100	Ø130	180€
661-DWECO A01000150	Ø100	Ø150	226€
661-DWECO A01000180	Ø100	Ø180	275€
661-DWECO A01000200	Ø100	Ø200	317€
661-DWECO A01000250	Ø100	Ø250	379€
661-DWECO A01300150	Ø130	Ø150	206€
661-DWECO A01300180	Ø130	Ø180	267€
661-DWECO A01300200	Ø130	Ø200	303€
661-DWECO A01300250	Ø130	Ø250	364€
661-DWECO A01300300	Ø130	Ø300	427€
661-DWECO A01500180	Ø150	Ø180	242€
661-DWECO A01500200	Ø150	Ø200	290€
661-DWECO A01500250	Ø150	Ø250	348€
661-DWECO A01500300	Ø150	Ø300	412€
661-DWECO A01500350	Ø150	Ø350	563€
661-DWECO A01800200	Ø180	Ø200	266€
661-DWECO A01800250	Ø180	Ø250	333€
661-DWECO A01800300	Ø180	Ø300	391€
661-DWECO A01800350	Ø180	Ø350	540€
661-DWECO A01800400	Ø180	Ø400	732€
661-DWECO A02000250	Ø200	Ø250	303€
661-DWECO A02000300	Ø200	Ø300	375€
661-DWECO A02000350	Ø200	Ø350	517€
661-DWECO A02000400	Ø200	Ø400	702€
661-DWECO A02000450	Ø200	Ø450	916€
661-DWECO A02500300	Ø250	Ø300	341€
661-DWECO A02500350	Ø250	Ø350	497€
661-DWECO A02500400	Ø250	Ø400	670€
661-DWECO A02500450	Ø250	Ø450	876€
661-DWECO A02500500	Ø250	Ø500	1036€
661-DWECO A03000350	Ø300	Ø350	452€
661-DWECO A03000400	Ø300	Ø400	647€

661-DWECO A03000450	Ø300	Ø450	840€
661-DWECO A03000500	Ø300	Ø500	996€
661-DWECO A03000550	Ø300	Ø550	1101€
661-DWECO A03500400	Ø350	Ø400	587€
661-DWECO A03500450	Ø350	Ø450	803€
661-DWECO A03500500	Ø350	Ø500	957€
661-DWECO A03500550	Ø350	Ø550	1055€
661-DWECO A03500600	Ø350	Ø600	1343€
661-DWECO A04000450	Ø400	Ø450	731€
661-DWECO A04000500	Ø400	Ø500	916€
661-DWECO A04000550	Ø400	Ø550	1014€
661-DWECO A04000600	Ø400	Ø600	1286€
661-DWECO A04000650	Ø400	Ø650	1752€
661-DWECO A04500500	Ø450	Ø500	829€
661-DWECO A04500550	Ø450	Ø550	966€
661-DWECO A04500600	Ø450	Ø600	1235€
661-DWECO A04500650	Ø450	Ø650	1682€
661-DWECO A04500700	Ø450	Ø700	1855€
661-DWECO A05000550	Ø500	Ø550	880€
661-DWECO A05000600	Ø500	Ø600	1182€
661-DWECO A05000650	Ø500	Ø650	1615€
661-DWECO A05000700	Ø500	Ø700	1781€
661-DWECO A05000750	Ø500	Ø750	1967€
661-DWECO A05500600	Ø550	Ø600	1073€
661-DWECO A05500650	Ø550	Ø650	1540€
661-DWECO A05500700	Ø550	Ø700	1708€
661-DWECO A05500750	Ø550	Ø750	1891€
661-DWECO A05500800	Ø550	Ø800	2187€
661-DWECO A06000650	Ø600	Ø650	1400€
661-DWECO A06000700	Ø600	Ø700	1632€
661-DWECO A06000750	Ø600	Ø750	1814€
661-DWECO A06000800	Ø600	Ø800	2098€
661-DWECO A06500700	Ø650	Ø700	1486€
661-DWECO A06500750	Ø650	Ø750	1732€
661-DWECO A06500800	Ø650	Ø800	2010€
661-DWECO A07000750	Ø700	Ø750	1576€
661-DWECO A07000800	Ø700	Ø800	1921€
661-DWECO A07500800	Ø750	Ø800	1747€

## AMPLIACIONES EXCÉNTRICAS

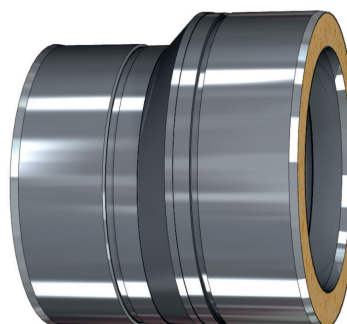
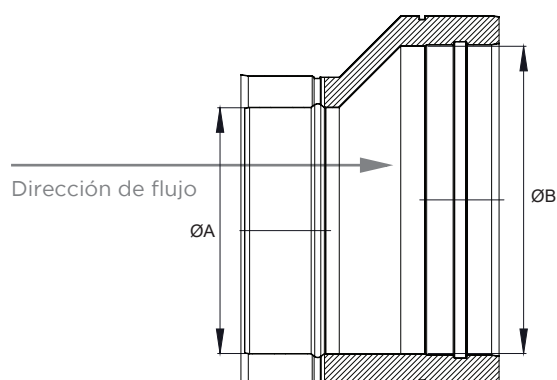

CÓDIGO	Ø A	Ø B	€
661-DWECOAX00800100	Ø80	Ø100	178€
661-DWECOAX00800130	Ø80	Ø130	254€
661-DWECOAX00800150	Ø80	Ø150	306€
661-DWECOAX00800180	Ø80	Ø180	378€
661-DWECOAX00800200	Ø80	Ø200	427€
661-DWECOAX01000130	Ø100	Ø130	235€
661-DWECOAX01000150	Ø100	Ø150	295€
661-DWECOAX01000180	Ø100	Ø180	361€
661-DWECOAX01000200	Ø100	Ø200	412€
661-DWECOAX01000250	Ø100	Ø250	496€
661-DWECOAX01300150	Ø130	Ø150	268€
661-DWECOAX01300180	Ø130	Ø180	344€
661-DWECOAX01300200	Ø130	Ø200	393€
661-DWECOAX01300250	Ø130	Ø250	471€
661-DWECOAX01300300	Ø130	Ø300	556€
661-DWECOAX01500180	Ø150	Ø180	316€
661-DWECOAX01500200	Ø150	Ø200	378€
661-DWECOAX01500250	Ø150	Ø250	453€
661-DWECOAX01500300	Ø150	Ø300	534€
661-DWECOAX01500350	Ø150	Ø350	730€
661-DWECOAX01800200	Ø180	Ø200	341€
661-DWECOAX01800250	Ø180	Ø250	430€
661-DWECOAX01800300	Ø180	Ø300	508€
661-DWECOAX01800350	Ø180	Ø350	701€
661-DWECOAX01800400	Ø180	Ø400	955€
661-DWECOAX02000250	Ø200	Ø250	393€
661-DWECOAX02000300	Ø200	Ø300	488€
661-DWECOAX02000350	Ø200	Ø350	668€
661-DWECOAX02000400	Ø200	Ø400	916€
661-DWECOAX02000450	Ø200	Ø450	1191€
661-DWECOAX02500300	Ø250	Ø300	447€
661-DWECOAX02500350	Ø250	Ø350	647€
661-DWECOAX02500400	Ø250	Ø400	873€
661-DWECOAX02500450	Ø250	Ø450	1138€
661-DWECOAX02500500	Ø250	Ø500	1348€
661-DWECOAX03000350	Ø300	Ø350	586€
661-DWECOAX03000400	Ø300	Ø400	838€

661-DWECOAX03000450	Ø300	Ø450	1091€
661-DWECOAX03000500	Ø300	Ø500	1295€
661-DWECOAX03000550	Ø300	Ø550	1429€
661-DWECOAX03500400	Ø350	Ø400	761€
661-DWECOAX03500450	Ø350	Ø450	1046€
661-DWECOAX03500500	Ø350	Ø500	1242€
661-DWECOAX03500550	Ø350	Ø550	1372€
661-DWECOAX03500600	Ø350	Ø600	1744€
661-DWECOAX04000450	Ø400	Ø450	954€
661-DWECOAX04000500	Ø400	Ø500	1191€
661-DWECOAX04000550	Ø400	Ø550	1316€
661-DWECOAX04000600	Ø400	Ø600	1675€
661-DWECOAX04000650	Ø400	Ø650	2278€
661-DWECOAX04500500	Ø450	Ø500	1080€
661-DWECOAX04500550	Ø450	Ø550	1255€
661-DWECOAX04500600	Ø450	Ø600	1608€
661-DWECOAX04500650	Ø450	Ø650	2187€
661-DWECOAX04500700	Ø450	Ø700	2411€
661-DWECOAX05000550	Ø500	Ø550	1141€
661-DWECOAX05000600	Ø500	Ø600	1535€
661-DWECOAX05000650	Ø500	Ø650	2093€
661-DWECOAX05000700	Ø500	Ø700	2315€
661-DWECOAX05000750	Ø500	Ø750	2559€
661-DWECOAX05500600	Ø550	Ø600	1398€
661-DWECOAX05500650	Ø550	Ø650	2004€
661-DWECOAX05500700	Ø550	Ø700	2222€
661-DWECOAX05500750	Ø550	Ø750	2454€
661-DWECOAX05500800	Ø550	Ø800	2838€
661-DWECOAX06000650	Ø600	Ø650	1822€
661-DWECOAX06000700	Ø600	Ø700	2124€
661-DWECOAX06000750	Ø600	Ø750	2355€
661-DWECOAX06000800	Ø600	Ø800	2724€
661-DWECOAX06500700	Ø650	Ø700	1933€
661-DWECOAX06500750	Ø650	Ø750	2250€
661-DWECOAX06500800	Ø650	Ø800	2611€
661-DWECOAX07000750	Ø700	Ø750	2047€
661-DWECOAX07000800	Ø700	Ø800	2500€
661-DWECOAX07500800	Ø750	Ø800	2274€



# CHIMENEA INDIVIDUAL

## Sistema DW - ECO 2.0 316

### REDUCCIONES

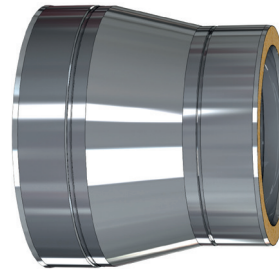
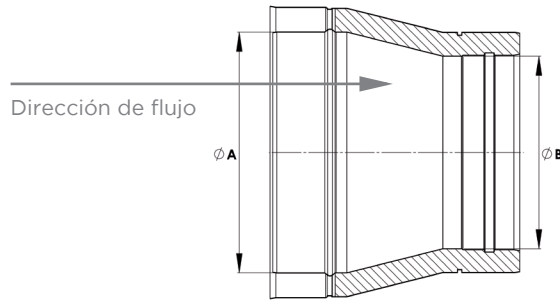

CÓDIGO	Ø A	Ø B	€
661-DWECOR01000080	Ø100	Ø80	138€
661-DWECOR01300080	Ø130	Ø80	199€
661-DWECOR01300100	Ø130	Ø100	180€
661-DWECOR01500080	Ø150	Ø80	239€
661-DWECOR01500100	Ø150	Ø100	226€
661-DWECOR01500130	Ø150	Ø130	206€
661-DWECOR01800080	Ø180	Ø80	290€
661-DWECOR01800100	Ø180	Ø100	275€
661-DWECOR01800130	Ø180	Ø130	267€
661-DWECOR01800150	Ø180	Ø150	242€
661-DWECOR02000080	Ø200	Ø80	329€
661-DWECOR02000100	Ø200	Ø100	317€
661-DWECOR02000130	Ø200	Ø130	303€
661-DWECOR02000150	Ø200	Ø150	290€
661-DWECOR02000180	Ø200	Ø180	266€
661-DWECOR02500100	Ø250	Ø100	379€
661-DWECOR02500130	Ø250	Ø130	364€
661-DWECOR02500150	Ø250	Ø150	348€
661-DWECOR02500180	Ø250	Ø180	333€
661-DWECOR02500200	Ø250	Ø200	303€
661-DWECOR03000130	Ø300	Ø130	427€
661-DWECOR03000150	Ø300	Ø150	412€
661-DWECOR03000180	Ø300	Ø180	391€
661-DWECOR03000200	Ø300	Ø200	375€
661-DWECOR03000250	Ø300	Ø250	341€
661-DWECOR03500150	Ø350	Ø150	563€
661-DWECOR03500180	Ø350	Ø180	540€
661-DWECOR03500200	Ø350	Ø200	517€
661-DWECOR03500250	Ø350	Ø250	497€
661-DWECOR03500300	Ø350	Ø300	452€
661-DWECOR04000180	Ø400	Ø180	732€
661-DWECOR04000200	Ø400	Ø200	702€
661-DWECOR04000250	Ø400	Ø250	670€
661-DWECOR04000300	Ø400	Ø300	647€
661-DWECOR04000350	Ø400	Ø350	587€
661-DWECOR04500200	Ø450	Ø200	916€
661-DWECOR04500250	Ø450	Ø250	876€

661-DWECOR04500300	Ø450	Ø300	840€
661-DWECOR04500350	Ø450	Ø350	803€
661-DWECOR04500400	Ø450	Ø400	731€
661-DWECOR05000250	Ø500	Ø250	1036€
661-DWECOR05000300	Ø500	Ø300	996€
661-DWECOR05000350	Ø500	Ø350	957€
661-DWECOR05000400	Ø500	Ø400	916€
661-DWECOR05000450	Ø500	Ø450	829€
661-DWECOR05500300	Ø550	Ø300	1101€
661-DWECOR05500350	Ø550	Ø350	1055€
661-DWECOR05500400	Ø550	Ø400	1014€
661-DWECOR05500450	Ø550	Ø450	966€
661-DWECOR05500500	Ø550	Ø500	880€
661-DWECOR06000350	Ø600	Ø350	1343€
661-DWECOR06000400	Ø600	Ø400	1286€
661-DWECOR06000450	Ø600	Ø450	1235€
661-DWECOR06000500	Ø600	Ø500	1182€
661-DWECOR06000550	Ø600	Ø550	1073€
661-DWECOR06500400	Ø650	Ø400	1752€
661-DWECOR06500450	Ø650	Ø450	1682€
661-DWECOR06500500	Ø650	Ø500	1615€
661-DWECOR06500550	Ø650	Ø550	1540€
661-DWECOR06500600	Ø650	Ø600	1400€
661-DWECOR07000450	Ø700	Ø450	1855€
661-DWECOR07000500	Ø700	Ø500	1781€
661-DWECOR07000550	Ø700	Ø550	1708€
661-DWECOR07000600	Ø700	Ø600	1632€
661-DWECOR07000650	Ø700	Ø650	1486€
661-DWECOR07500500	Ø750	Ø500	1967€
661-DWECOR07500550	Ø750	Ø550	1891€
661-DWECOR07500600	Ø750	Ø600	1814€
661-DWECOR07500650	Ø750	Ø650	1732€
661-DWECOR07500700	Ø750	Ø700	1576€
661-DWECOR08000550	Ø800	Ø550	2187€
661-DWECOR08000600	Ø800	Ø600	2098€
661-DWECOR08000650	Ø800	Ø650	2010€
661-DWECOR08000700	Ø800	Ø700	1921€
661-DWECOR08000750	Ø800	Ø750	1747€

## REDUCCIONES EXCÉNTRICAS

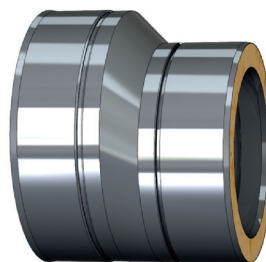
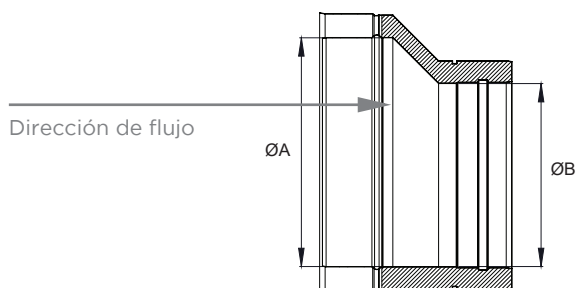

CÓDIGO	Ø A	Ø B	€
661-DWECORX01000080	Ø100	Ø80	178€
661-DWECORX01300080	Ø130	Ø80	254€
661-DWECORX01300100	Ø130	Ø100	235€
661-DWECORX01500080	Ø150	Ø80	306€
661-DWECORX01500100	Ø150	Ø100	295€
661-DWECORX01500130	Ø150	Ø130	268€
661-DWECORX01800080	Ø180	Ø80	378€
661-DWECORX01800100	Ø180	Ø100	361€
661-DWECORX01800130	Ø180	Ø130	344€
661-DWECORX01800150	Ø180	Ø150	316€
661-DWECORX02000080	Ø200	Ø80	427€
661-DWECORX02000100	Ø200	Ø100	412€
661-DWECORX02000130	Ø200	Ø130	393€
661-DWECORX02000150	Ø200	Ø150	378€
661-DWECORX02000180	Ø200	Ø180	341€
661-DWECORX02500100	Ø250	Ø100	496€
661-DWECORX02500130	Ø250	Ø130	471€
661-DWECORX02500150	Ø250	Ø150	453€
661-DWECORX02500180	Ø250	Ø180	430€
661-DWECORX02500200	Ø250	Ø200	393€
661-DWECORX03000130	Ø300	Ø130	556€
661-DWECORX03000150	Ø300	Ø150	534€
661-DWECORX03000180	Ø300	Ø180	508€
661-DWECORX03000200	Ø300	Ø200	488€
661-DWECORX03000250	Ø300	Ø250	447€
661-DWECORX03500150	Ø350	Ø150	730€
661-DWECORX03500180	Ø350	Ø180	701€
661-DWECORX03500200	Ø350	Ø200	668€
661-DWECORX03500250	Ø350	Ø250	647€
661-DWECORX03500300	Ø350	Ø300	586€
661-DWECORX04000180	Ø400	Ø180	955€
661-DWECORX04000200	Ø400	Ø200	916€
661-DWECORX04000250	Ø400	Ø250	873€
661-DWECORX04000300	Ø400	Ø300	838€
661-DWECORX04000350	Ø400	Ø350	761€
661-DWECORX04500200	Ø450	Ø200	1191€
661-DWECORX04500250	Ø450	Ø250	1138€

661-DWECORX04500300	Ø450	Ø300	1091€
661-DWECORX04500350	Ø450	Ø350	1046€
661-DWECORX04500400	Ø450	Ø400	954€
661-DWECORX05000250	Ø500	Ø250	1348€
661-DWECORX05000300	Ø500	Ø300	1295€
661-DWECORX05000350	Ø500	Ø350	1242€
661-DWECORX05000400	Ø500	Ø400	1191€
661-DWECORX05000450	Ø500	Ø450	1080€
661-DWECORX05500300	Ø550	Ø300	1429€
661-DWECORX05500350	Ø550	Ø350	1372€
661-DWECORX05500400	Ø550	Ø400	1316€
661-DWECORX05500450	Ø550	Ø450	1255€
661-DWECORX05500500	Ø550	Ø500	1141€
661-DWECORX06000350	Ø600	Ø350	1744€
661-DWECORX06000400	Ø600	Ø400	1675€
661-DWECORX06000450	Ø600	Ø450	1608€
661-DWECORX06000500	Ø600	Ø500	1535€
661-DWECORX06000550	Ø600	Ø550	1398€
661-DWECORX06500400	Ø650	Ø400	2278€
661-DWECORX06500450	Ø650	Ø450	2187€
661-DWECORX06500500	Ø650	Ø500	2093€
661-DWECORX06500550	Ø650	Ø550	2004€
661-DWECORX06500600	Ø650	Ø600	1822€
661-DWECORX07000450	Ø700	Ø450	2411€
661-DWECORX07000500	Ø700	Ø500	2315€
661-DWECORX07000550	Ø700	Ø550	2222€
661-DWECORX07000600	Ø700	Ø600	2124€
661-DWECORX07000650	Ø700	Ø650	1933€
661-DWECORX07500500	Ø750	Ø500	2559€
661-DWECORX07500550	Ø750	Ø550	2454€
661-DWECORX07500600	Ø750	Ø600	2355€
661-DWECORX07500650	Ø750	Ø650	2250€
661-DWECORX07500700	Ø750	Ø700	2047€
661-DWECORX08000550	Ø800	Ø550	2838€
661-DWECORX08000600	Ø800	Ø600	2724€
661-DWECORX08000650	Ø800	Ø650	2611€
661-DWECORX08000700	Ø800	Ø700	2500€
661-DWECORX08000750	Ø800	Ø750	2274€



# CHIMENEA INDIVIDUAL

## Sistema DW - ECO 2.0 304

**Chimenea modular metálica para evacuación de humos y gases de los productos de la combustión de doble pared fabricada en acero inoxidable interior y exterior.**

### MATERIAL

Pared Interior: AISI 304  
Pared Exterior: AISI 304

### ACABADO EXTERIOR

Brillante  
Colores RAL (consulta página 14 para acabados especiales)  
Exterior galvanizado / zincado -15% (sólo tramos rectos y desviaciones)

### AISLAMIENTO

Lana de roca rígida de alta densidad (120kg/m<sup>3</sup>)

### ESPEORES (mm)

Pared interior: 0,4 - 0,5 - 0,6 - 0,8 (según diámetro)  
Aislamiento: 25 mm (32 mm a partir de Ø650 mm)  
Pared exterior: 0,4 - 0,5 - 0,6 - 0,8 (según diámetro)

### DIÁMETROS DISPONIBLES (mm)

Ø250 a Ø800

### SISTEMA DE UNIÓN

Conexión macho-hembra con **abrazadera de unión ancha (2.0)**

### NIVEL DE ESTANQUEIDAD

T--- - N1: Sin necesidad de junta  
T200 - H1: Incluir junta de estanqueidad (DW2526Ø).\*

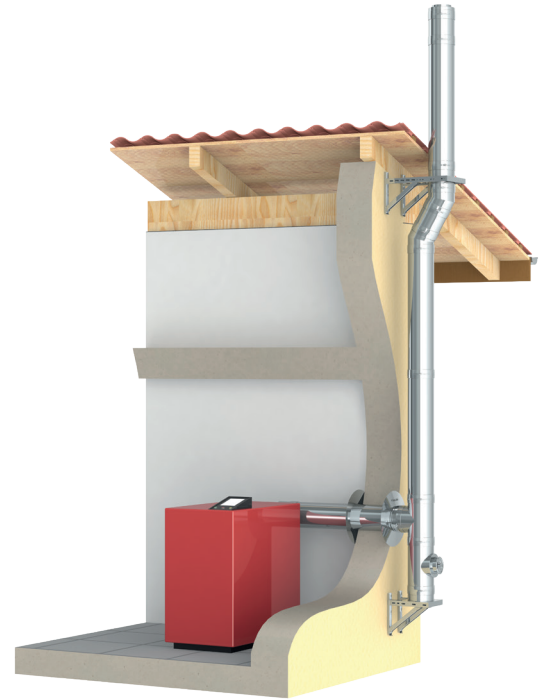

Para incluir la junta de estanqueidad (T<200°C). preinstalada de fábrica, sustituir los códigos 660 por C05\* y los códigos 661 por D01\* Excepto terminales.



## APLICACIONES

- Calderas de gas y gasoil
- No condensación
- Calderas de vapor
- Hornos de panadería
- Generadores de aire caliente
- Climatización



## CARACTERÍSTICAS

- Temperatura de trabajo hasta 600°C
- **Soldadura TIG/LÁSER** en continuo en todas las piezas
- **Abrazadera de unión incluida (excepto terminales)**
- Posibilidad de **corte de módulos rectos a medida** en obra (ver instrucciones de corte página 53)
- Chimenea con clasificación de **resistencia al fuego**

## CERTIFICADO CE

0036 CPR 9174 030  
0036 CPR 9174 044

## CLASIFICACIONES CE (UNE-EN 1856-1)

T600 - N1 - D - Vm - L20040 - G(70)  
T450 - N1 - D - Vm - L20040 - G(60)  
T400 - N1 - W - Vm - L20040 - O(30)  
T200 - P1 - W - Vm - L20040 - O(00) (con junta de estanqueidad DW2526)  
T200 - H1 - W - Vm - L20040 - O(00) (con junta de estanqueidad DW2526)

## CLASIFICACIONES DE RESISTENCIA AL FUEGO SEGÚN EN 13501-2

EI180 ve (o-->i) T200  
EI120 ve (o-->i) T600  
EI120 ho (o-->i) T600



Módulo recto 1000mm



Módulo recto 500mm



Módulo recto 250mm



Módulo recto regulable  
400-560mm



Módulo recto regulable  
560-920mm

Ø250	660-DWECO130250	287€	Ø250	660-DWECO140250	183€	Ø250	660-DWECO150250	132€	Ø250	660-DWECO5440250	260€	Ø250	660-DWECO5450250	356€
Ø300	660-DWECO130300	356€	Ø300	660-DWECO140300	236€	Ø300	660-DWECO150300	170€	Ø300	660-DWECO5440300	327€	Ø300	660-DWECO5450300	504€
Ø350	660-DWECO130350	444€	Ø350	660-DWECO140350	296€	Ø350	660-DWECO150350	226€	Ø350	660-DWECO5440350	421€	Ø350	660-DWECO5450350	632€
Ø400	660-DWECO130400	494€	Ø400	660-DWECO140400	351€	Ø400	660-DWECO150400	274€	Ø400	660-DWECO5440400	505€	Ø400	660-DWECO5450400	728€
Ø450	660-DWECO130450	530€	Ø450	660-DWECO140450	365€	Ø450	660-DWECO150450	300€	Ø450	660-DWECO5440450	551€	Ø450	660-DWECO5450450	752€
Ø500	660-DWECO130500	570€	Ø500	660-DWECO140500	375€	Ø500	660-DWECO150500	330€	Ø500	660-DWECO5440500	577€	Ø500	660-DWECO5450500	785€
Ø550	660-DWECO130550	649€	Ø550	660-DWECO140550	488€	Ø550	660-DWECO150550	370€	Ø550	660-DWECO5440550	612€	Ø550	660-DWECO5450550	806€
Ø600	660-DWECO130600	799€	Ø600	660-DWECO140600	584€	Ø600	660-DWECO150600	473€	Ø600	660-DWECO5440600	756€	Ø600	660-DWECO5450600	1089€
Ø650	660-DWECO130650	997€	Ø650	660-DWECO140650	730€	Ø650	660-DWECO150650	595€	Ø650	660-DWECO5440650	947€	Ø650	660-DWECO5450650	1363€
Ø700	660-DWECO130700	1050€	Ø700	660-DWECO140700	763€	Ø700	660-DWECO150700	621€	Ø700	660-DWECO5440700	990€	Ø700	660-DWECO5450700	1433€
Ø750	660-DWECO130750	1112€	Ø750	660-DWECO140750	815€	Ø750	660-DWECO150750	659€	Ø750	660-DWECO5440750	1052€	Ø750	660-DWECO5450750	1519€
Ø800	660-DWECO130800	1246€	Ø800	660-DWECO140800	907€	Ø800	660-DWECO150800	739€	Ø800	660-DWECO5440800	1172€	Ø800	660-DWECO5450800	1700€

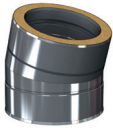

Codo 15°

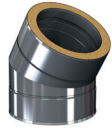

Codo 30°



Codo 45°



Codo 60°

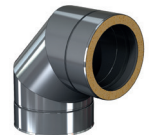

Codo 90°

Ø250	660-DWECO160250	183€	Ø250	660-DWECO170250	183€	Ø250	660-DWECO180250	183€	Ø250	660-DWECO840250	222€	Ø250	660-DWECO600250	268€
Ø300	660-DWECO160300	220€	Ø300	660-DWECO170300	220€	Ø300	660-DWECO180300	220€	Ø300	660-DWECO840300	286€	Ø300	660-DWECO600300	348€
Ø350	660-DWECO160350	300€	Ø350	660-DWECO170350	300€	Ø350	660-DWECO180350	300€	Ø350	660-DWECO840350	367€	Ø350	660-DWECO600350	436€
Ø400	660-DWECO160400	378€	Ø400	660-DWECO170400	378€	Ø400	660-DWECO180400	378€						
Ø450	660-DWECO160450	544€	Ø450	660-DWECO170450	544€	Ø450	660-DWECO180450	544€						
Ø500	660-DWECO160500	611€	Ø500	660-DWECO170500	611€	Ø500	660-DWECO180500	611€						
Ø550	660-DWECO160550	852€	Ø550	660-DWECO170550	852€	Ø550	660-DWECO180550	852€						
Ø600	660-DWECO160600	1009€	Ø600	660-DWECO170600	1009€	Ø600	660-DWECO180600	1009€						
Ø650	660-DWECO160650	1260€	Ø650	660-DWECO170650	1260€	Ø650	660-DWECO180650	1260€						
Ø700	660-DWECO160700	1323€	Ø700	660-DWECO170700	1323€	Ø700	660-DWECO180700	1323€						
Ø750	660-DWECO160750	1404€	Ø750	660-DWECO170750	1404€	Ø750	660-DWECO180750	1404€						
Ø800	660-DWECO160800	1571€	Ø800	660-DWECO170800	1571€	Ø800	660-DWECO180800	1571€						



# CHIMENEA INDIVIDUAL

## Sistema DW - ECO 2.0 304



Te 90°



Te 135°

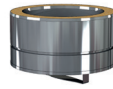

Colector de hollín aislado

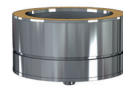

Colector de hollín con  
desagüe aislado



Codo 90° con tapa de  
inspección P1

Ø250	660-DWECO3170250	410€	Ø250	660-DWECO120250	655€	Ø250	660-DWECO20330250	117€	Ø250	660-DWECO14600250	137€	Ø250	660-DWECO19AL0250	370€
Ø300	660-DWECO3170300	529€	Ø300	660-DWECO120300	744€	Ø300	660-DWECO20330300	138€	Ø300	660-DWECO14600300	210€	Ø300	660-DWECO19AL0300	436€
Ø350	660-DWECO3170350	659€	Ø350	660-DWECO120350	899€	Ø350	660-DWECO20330350	151€	Ø350	660-DWECO14600350	241€	Ø350	660-DWECO19AL0350	681€
Ø400	660-DWECO3170400	822€	Ø400	660-DWECO120400	1225€	Ø400	660-DWECO20330400	178€	Ø400	660-DWECO14600400	252€			
Ø450	660-DWECO3170450	931€	Ø450	660-DWECO120450	1367€	Ø450	660-DWECO20330450	199€	Ø450	660-DWECO14600450	297€			
Ø500	660-DWECO3170500	1102€	Ø500	660-DWECO120500	1399€	Ø500	660-DWECO20330500	295€	Ø500	660-DWECO14600500	365€			
Ø550	660-DWECO3170550	1197€	Ø550	660-DWECO120550	2799€	Ø550	660-DWECO20330550	363€	Ø550	660-DWECO14600550	438€			
Ø600	660-DWECO3170600	1470€	Ø600	660-DWECO120600	2954€	Ø600	660-DWECO20330600	338€	Ø600	660-DWECO14600600	454€			
Ø650	660-DWECO3170650	1836€	Ø650	660-DWECO120650	3692€	Ø650	660-DWECO20330650	387€	Ø650	660-DWECO14600650	494€			
Ø700	660-DWECO3170700	1930€	Ø700	660-DWECO120700	3876€	Ø700	660-DWECO20330700	415€	Ø700	660-DWECO14600700	529€			
Ø750	660-DWECO3170750	2044€	Ø750	660-DWECO120750	4109€	Ø750	660-DWECO20330750	444€	Ø750	660-DWECO14600750	567€			
Ø800	660-DWECO3170800	2290€	Ø800	660-DWECO120800	4602€	Ø800	660-DWECO20330800	472€	Ø800	660-DWECO14600800	603€			



Módulo de inspección



Módulo de inspección con  
tapa 40 Pa (N1)



Módulo de medioambiente



Módulo temperatura humos



Terminal salida libre

Ø250	661-DWECO5430250	268€	Ø250	661-DWECO680250	322€	Ø250	661-DWECO12680250	739€	Ø250	661-DWECO870250	920€	Ø250	661-DWECO320250	141€
Ø300	661-DWECO5430300	343€	Ø300	661-DWECO680300	351€	Ø300	661-DWECO12680300	805€	Ø300	661-DWECO870300	981€	Ø300	661-DWECO320300	184€
Ø350	661-DWECO5430350	428€	Ø350	661-DWECO680350	373€	Ø350	661-DWECO12680350	1295€	Ø350	661-DWECO870350	1096€	Ø350	661-DWECO320350	234€
Ø400	661-DWECO5430400	538€	Ø400	661-DWECO680400	533€	Ø400	661-DWECO12680400	1380€	Ø400	661-DWECO870400	1157€	Ø400	661-DWECO320400	287€
Ø450	661-DWECO5430450	586€	Ø450	661-DWECO680450	575€	Ø450	661-DWECO12680450	1446€	Ø450	661-DWECO870450	1255€	Ø450	661-DWECO320450	316€
Ø500	661-DWECO5430500	637€	Ø500	661-DWECO680500	612€	Ø500	661-DWECO12680500	1514€	Ø500	661-DWECO870500	1368€	Ø500	661-DWECO320500	341€
Ø550	661-DWECO5430550	663€	Ø550	661-DWECO680550	648€	Ø550	661-DWECO12680550	1632€	Ø550	661-DWECO870550	1469€	Ø550	661-DWECO320550	363€
Ø600	661-DWECO5430600	695€	Ø600	661-DWECO680600	686€	Ø600	661-DWECO12680600	1721€	Ø600	661-DWECO870600	1490€	Ø600	661-DWECO320600	369€
Ø650	661-DWECO5430650	905€	Ø650	661-DWECO680650	770€	Ø650	661-DWECO12680650	1865€	Ø650	661-DWECO870650	1947€	Ø650	661-DWECO320650	483€
Ø700	661-DWECO5430700	961€	Ø700	661-DWECO680700	828€	Ø700	661-DWECO12680700	2007€	Ø700	661-DWECO870700	2062€	Ø700	661-DWECO320700	511€
Ø750	661-DWECO5430750	1019€	Ø750	661-DWECO680750	867€	Ø750	661-DWECO12680750	2152€	Ø750	661-DWECO870750	2189€	Ø750	661-DWECO320750	544€
Ø800	661-DWECO5430800	1129€	Ø800	661-DWECO680800	907€	Ø800	661-DWECO12680800	2293€	Ø800	661-DWECO870800	2430€	Ø800	661-DWECO320800	606€



Terminal salida cónica



Terminal anti-lluvia

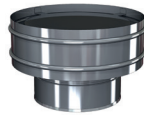

Terminal anti-viento

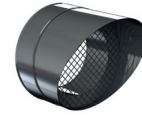

Terminal horizontal con rejilla



Adaptador a Hurricane

Ø250	661-DWECO32C0250	163€	Ø250	661-DWECO5260250	200€	Ø250	661-DWECO5270250	287€	Ø250	661-DWECO5320250	178€	Ø250	660-DWECO44760250	268€
Ø300	661-DWECO32C0300	211€	Ø300	661-DWECO5260300	256€	Ø300	661-DWECO5270300	369€	Ø300	661-DWECO5320300	233€	Ø300	660-DWECO44760300	305€
Ø350	661-DWECO32C0350	268€	Ø350	661-DWECO5260350	322€	Ø350	661-DWECO5270350	449€	Ø350	661-DWECO5320350	290€			
Ø400	661-DWECO32C0400	329€	Ø400	661-DWECO5260400	401€	Ø400	661-DWECO5270400	553€	Ø400	661-DWECO5320400	358€			
Ø450	661-DWECO32C0450	363€	Ø450	661-DWECO5260450	876€				Ø450	661-DWECO5320450	447€			
Ø500	661-DWECO32C0500	391€	Ø500	661-DWECO5260500	888€				Ø500	661-DWECO5320500	466€			
Ø550	661-DWECO32C0550	415€	Ø550	661-DWECO5260550	1000€				Ø550	661-DWECO5320550	655€			
Ø600	661-DWECO32C0600	427€	Ø600	661-DWECO5260600	1023€				Ø600	661-DWECO5320600	736€			
Ø650	661-DWECO32C0650	556€							Ø650	661-DWECO5320650	798€			
Ø700	661-DWECO32C0700	591€							Ø700	661-DWECO5320700	859€			
Ø750	661-DWECO32C0750	625€							Ø750	661-DWECO5320750	920€			
Ø800	661-DWECO32C0800	698€							Ø800	661-DWECO5320800	984€			



Adaptador doble a simple

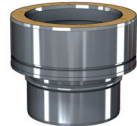

Adaptador simple a doble

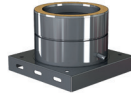

Placa base con desagüe lateral

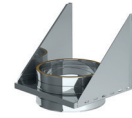

Soporte de carga regulable



Pasamuros EI

Ø250	660-DWECO37A0250	91€	Ø250	660-DWECO370250	91€	Ø250	661-DWECO60250	363€	Ø250	660-DWECO3790250	334€	Ø250	660-DWECO43300250	670€
Ø300	660-DWECO37A0300	117€	Ø300	660-DWECO370300	117€	Ø300	661-DWECO60300	389€	Ø300	660-DWECO3790300	436€	Ø300	660-DWECO43300300	773€
Ø350	660-DWECO37A0350	146€	Ø350	660-DWECO370350	146€	Ø350	661-DWECO60350	454€	Ø350	660-DWECO3790350	541€	Ø350	660-DWECO43300350	884€
Ø400	660-DWECO37A0400	183€	Ø400	660-DWECO370400	183€	Ø400	661-DWECO60400	555€	Ø400	660-DWECO3790400	678€	Ø400	660-DWECO43300400	1025€
Ø450	660-DWECO37A0450	211€	Ø450	660-DWECO370450	211€	Ø450	661-DWECO60450	606€	Ø450	660-DWECO3790450	736€	Ø450	660-DWECO43300450	1170€
Ø500	660-DWECO37A0500	218€	Ø500	660-DWECO370500	218€	Ø500	661-DWECO60500	658€	Ø500	660-DWECO3790500	802€	Ø500	660-DWECO43300500	1313€
Ø550	660-DWECO37A0550	242€	Ø550	660-DWECO370550	242€	Ø550	661-DWECO60550	776€	Ø550	660-DWECO3790550	922€	Ø550	660-DWECO43300550	1417€
Ø600	660-DWECO37A0600	260€	Ø600	660-DWECO370600	260€	Ø600	661-DWECO60600	840€	Ø600	660-DWECO3790600	1026€	Ø600	660-DWECO43300600	1560€
Ø650	660-DWECO37A0650	327€	Ø650	660-DWECO370650	327€	Ø650	661-DWECO60650	1101€	Ø650	660-DWECO3790650	1283€	Ø650	660-DWECO43300650	1664€
Ø700	660-DWECO37A0700	341€	Ø700	660-DWECO370700	341€	Ø700	661-DWECO60700	1165€	Ø700	660-DWECO3790700	1346€	Ø700	660-DWECO43300700	1851€
Ø750	660-DWECO37A0750	364€	Ø750	660-DWECO370750	364€	Ø750	661-DWECO60750	1234€	Ø750	660-DWECO3790750	1426€	Ø750	660-DWECO43300750	1999€
Ø800	660-DWECO37A0800	408€	Ø800	660-DWECO370800	408€	Ø800	661-DWECO60800	1370€	Ø800	660-DWECO3790800	1598€	Ø800	660-DWECO43300800	2109€



# CHIMENEA INDIVIDUAL

## Sistema DW - ECO 2.0 304



Abrazadera de unión 2.0



Abrazadera fijación pared regulable 50-80mm



Abrazadera fijación pared fija



Base de abrazadera distanciadora



Alas distanciadoras A

Ø250	665-ZUWA9890300	30.9€	Ø250	665-ZUWA5560300	64€	Ø400	665-ZUWA556F0450	118€	Ø250	665-ZUWA14620300	138€	Ø250	665-ZUWA1462A	47.13€
Ø300	665-ZUWA9890350	34.15€	Ø300	665-ZUWA5560350	67€	Ø450	665-ZUWA556F0500	123€	Ø300	665-ZUWA14620350	185€	Ø300	665-ZUWA1462A	47.13€
Ø350	665-ZUWA9890400	42.42€	Ø350	665-ZUWA5560400	88€	Ø500	665-ZUWA556F0550	155€	Ø350	665-ZUWA14620400	241€	Ø350	665-ZUWA1462A	47.13€
Ø400	665-ZUWA9890450	48.72€	Ø400	665-ZUWA5560450	98€	Ø550	665-ZUWA556F0600	185€	Ø400	665-ZUWA14620450	298€	Ø400	665-ZUWA1462A	47.13€
Ø450	665-ZUWA9890500	54€				Ø600	665-ZUWA556F0650	203€	Ø450	665-ZUWA14620500	328€	Ø450	665-ZUWA1462A	47.13€
Ø500	665-ZUWA9890550	58€				Ø650	665-ZUWA556F0715	290€	Ø500	665-ZUWA14620550	365€	Ø500	665-ZUWA1462A	47.13€
Ø550	665-ZUWA9890600	66€				Ø700	665-ZUWA556F0765	337€	Ø550	665-ZUWA14620600	412€	Ø550	665-ZUWA1462A	47.13€
Ø600	665-ZUWA9890650	73€				Ø750	665-ZUWA556F0815	367€	Ø600	665-ZUWA14620650	444€	Ø600	665-ZUWA1462A	47.13€
Ø650	665-ZUWA9890715	96€				Ø800	665-ZUWA556F0865	387€	Ø650	665-ZUWA14620715	580€	Ø650	665-ZUWA1462A	47.13€
Ø700	665-ZUWA9890765	107€							Ø700	665-ZUWA14620765	688€	Ø700	665-ZUWA1462A	47.13€
Ø750	665-ZUWA9890815	114€							Ø750	665-ZUWA14620815	812€	Ø750	665-ZUWA1462A	47.13€
Ø800	665-ZUWA9890865	121€							Ø800	665-ZUWA14620865	850€	Ø800	665-ZUWA1462A	47.13€



Alas distanciadoras B



Alas distanciadoras C



Alas distanciadoras D

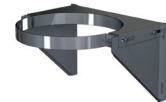

Abrazadera de soporte



Abrazadera con doble pértiga telescópica L=2000mm

Ø250	665-ZUWA1462B	65€	Ø250	665-ZUWA1462C	81€	Ø250	665-ZUWA1462D	104€	Ø250	665-ZUWA8580300	203€	Ø250	665-ZUWA1910300	233€
Ø300	665-ZUWA1462B	65€	Ø300	665-ZUWA1462C	81€	Ø300	665-ZUWA1462D	104€	Ø300	665-ZUWA8580350	221€	Ø300	665-ZUWA1910350	249€
Ø350	665-ZUWA1462B	65€	Ø350	665-ZUWA1462C	81€	Ø350	665-ZUWA1462D	104€	Ø350	665-ZUWA8580400	270€	Ø350	665-ZUWA1910400	272€
Ø400	665-ZUWA1462B	65€	Ø400	665-ZUWA1462C	81€	Ø400	665-ZUWA1462D	104€	Ø400	665-ZUWA8580450	321€	Ø400	665-ZUWA1910450	380€
Ø450	665-ZUWA1462B	65€	Ø450	665-ZUWA1462C	81€	Ø450	665-ZUWA1462D	104€	Ø450	665-ZUWA8580500	354€	Ø450	665-ZUWA1910500	496€
Ø500	665-ZUWA1462B	65€	Ø500	665-ZUWA1462C	81€	Ø500	665-ZUWA1462D	104€	Ø500	665-ZUWA8580550	401€	Ø500	665-ZUWA1910550	647€
Ø550	665-ZUWA1462B	65€	Ø550	665-ZUWA1462C	81€	Ø550	665-ZUWA1462D	104€	Ø550	665-ZUWA8580600	454€	Ø550	665-ZUWA1910600	699€
Ø600	665-ZUWA1462B	65€	Ø600	665-ZUWA1462C	81€	Ø600	665-ZUWA1462D	104€	Ø600	665-ZUWA8580650	492€	Ø600	665-ZUWA1910650	766€
Ø650	665-ZUWA1462B	65€	Ø650	665-ZUWA1462C	81€	Ø650	665-ZUWA1462D	104€	Ø650	665-ZUWA8580715	706€	Ø650	665-ZUWA1910715	930€
Ø700	665-ZUWA1462B	65€	Ø700	665-ZUWA1462C	81€	Ø700	665-ZUWA1462D	104€	Ø700	665-ZUWA8580765	825€	Ø700	665-ZUWA1910765	1055€
Ø750	665-ZUWA1462B	65€	Ø750	665-ZUWA1462C	81€	Ø750	665-ZUWA1462D	104€	Ø750	665-ZUWA8580815	899€	Ø750	665-ZUWA1910815	1164€
Ø800	665-ZUWA1462B	65€	Ø800	665-ZUWA1462C	81€	Ø800	665-ZUWA1462D	104€	Ø800	665-ZUWA8580865	943€	Ø800	665-ZUWA1910865	1222€



Necesario instalar collarín con el cubreaguas.

Consultar página 91 para ver distancias de separación.



Abrazadera fijacion a techo

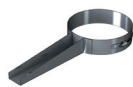

Abrazadera forjado inox



Abrazadera para amarre por tornillo



Abrazadera vientos

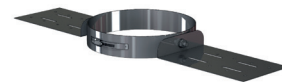

Soporte de techo

Ø250	665-ZUWA118B0300	88€	Ø250	665-ZUWA620300	59€	Ø250	665-ZUWA10630300	65€	Ø250	665-ZUWA420300	34.15€	Ø250	665-ZUWA9360300	84€
Ø300	665-ZUWA118B0350	100€	Ø300	665-ZUWA620350	66€	Ø300	665-ZUWA10630350	74€	Ø300	665-ZUWA420350	37.43€	Ø300	665-ZUWA9360350	95€
			Ø350	665-ZUWA620400	74€	Ø350	665-ZUWA10630400	84€	Ø350	665-ZUWA420400	40.87€	Ø350	665-ZUWA9360400	104€
			Ø400	665-ZUWA620450	83€	Ø400	665-ZUWA10630450	97€	Ø400	665-ZUWA420450	56€	Ø400	665-ZUWA9360450	144€
			Ø450	665-ZUWA620500	96€	Ø450	665-ZUWA10630500	106€	Ø450	665-ZUWA420500	74€	Ø450	665-ZUWA9360500	186€
			Ø500	665-ZUWA620550	103€	Ø500	665-ZUWA10630550	114€	Ø500	665-ZUWA420550	98€	Ø500	665-ZUWA9360550	241€
			Ø550	665-ZUWA620600	109€	Ø550	665-ZUWA10630600	129€	Ø550	665-ZUWA420600	106€	Ø550	665-ZUWA9360600	264€
			Ø600	665-ZUWA620650	115€	Ø600	665-ZUWA10630650	139€	Ø600	665-ZUWA420650	114€	Ø600	665-ZUWA9360650	286€
						Ø650	665-ZUWA10630715	157€	Ø650	665-ZUWA420715	168€	Ø650	665-ZUWA9360715	351€
						Ø700	665-ZUWA10630765	173€	Ø700	665-ZUWA420765	196€	Ø700	665-ZUWA9360765	397€
						Ø750	665-ZUWA10630815	185€	Ø750	665-ZUWA420815	210€	Ø750	665-ZUWA9360815	437€
						Ø800	665-ZUWA10630865	191€	Ø800	665-ZUWA420865	220€	Ø800	665-ZUWA9360865	456€



Collarín antitormenta

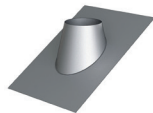

Cubreaguas 25°-45° aluminio

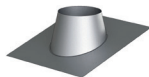

Cubreaguas 5°-25° aluminio

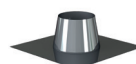

Cubreaguas plano inox

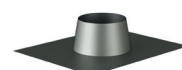

Cubreaguas plomo 0°-5°



Ø250	665-ZUWA3070300	71€	Ø250	665-ZUWA939AL0300	332€	Ø250	665-ZUWA938AL0300	317€	Ø250	665-ZUWA11280300	233€	Ø250	665-ZUWA9370300	323€
Ø300	665-ZUWA3070350	77€	Ø300	665-ZUWA939AL0350	387€	Ø300	665-ZUWA938AL0350	351€	Ø300	665-ZUWA11280350	260€	Ø300	665-ZUWA9370350	361€
Ø350	665-ZUWA3070400	83€	Ø350	665-ZUWA939AL0400	433€	Ø350	665-ZUWA938AL0400	390€	Ø350	665-ZUWA11280400	286€	Ø350	665-ZUWA9370400	396€
Ø400	665-ZUWA3070450	114€	Ø400	665-ZUWA939AL0450	492€	Ø400	665-ZUWA938AL0450	436€	Ø400	665-ZUWA11280450	306€	Ø400	665-ZUWA9370450	428€
Ø450	665-ZUWA3070500	151€	Ø450	665-ZUWA939AL0500	549€	Ø450	665-ZUWA938AL0500	488€	Ø450	665-ZUWA11280500	352€	Ø450	665-ZUWA9370500	488€
Ø500	665-ZUWA3070550	199€	Ø500	665-ZUWA939AL0550	607€	Ø500	665-ZUWA938AL0550	524€	Ø500	665-ZUWA11280550	389€	Ø500	665-ZUWA9370550	539€
Ø550	665-ZUWA3070600	211€	Ø550	665-ZUWA939AL0600	661€	Ø550	665-ZUWA938AL0600	573€	Ø550	665-ZUWA11280600	437€	Ø550	665-ZUWA9370600	606€
Ø600	665-ZUWA3070650	234€	Ø600	665-ZUWA939AL0650	730€	Ø600	665-ZUWA938AL0650	618€	Ø600	665-ZUWA11280650	492€	Ø600	665-ZUWA9370650	684€
Ø650	665-ZUWA3070715	283€	Ø650	665-ZUWA939AL0715	852€	Ø650	665-ZUWA938AL0715	684€	Ø650	665-ZUWA11280715	570€	Ø650	665-ZUWA9370715	789€
Ø700	665-ZUWA3070765	321€	Ø700	665-ZUWA939AL0765	950€	Ø700	665-ZUWA938AL0765	785€	Ø700	665-ZUWA11280765	598€	Ø700	665-ZUWA9370765	832€
Ø750	665-ZUWA3070815	356€	Ø750	665-ZUWA939AL0815	1192€	Ø750	665-ZUWA938AL0815	918€	Ø750	665-ZUWA11280815	633€	Ø750	665-ZUWA9370815	880€
Ø800	665-ZUWA3070865	369€	Ø800	665-ZUWA939AL0865	1297€	Ø800	665-ZUWA938AL0865	1055€	Ø800	665-ZUWA11280865	662€	Ø800	665-ZUWA9370865	920€



# CHIMENEA INDIVIDUAL

## Sistema DW - ECO 2.0 304



Necesario instalar collarin con el cubreaguas.

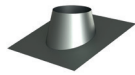
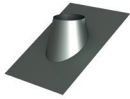

Cubreaguas plomo 25°-45°

Cubreaguas plomo 5°-25°

Pasamuros

Soporte cubierta ventilado

Junta de silicona  
(T<200°C)

Ø250	665-ZUWA9390300	417€	Ø250	665-ZUWA9380300	323€	Ø250	665-ZUWA9870300	83€	Ø250	665-ZUWA9340300	119€	Ø250	665-ZUWA260250	11.38€	
Ø300	665-ZUWA9390350	431€	Ø300	665-ZUWA9380350	361€	Ø300	665-ZUWA9870350	95€					Ø300	665-ZUWA260300	14.65€
Ø350	665-ZUWA9390400	454€	Ø350	665-ZUWA9380400	396€	Ø350	665-ZUWA9870400	121€					Ø350	665-ZUWA260350	17.9€
Ø400	665-ZUWA9390450	541€	Ø400	665-ZUWA9380450	428€	Ø400	665-ZUWA9870450	156€					Ø400	665-ZUWA260400	19.51€
Ø450	665-ZUWA9390500	618€	Ø450	665-ZUWA9380500	488€	Ø450	665-ZUWA9870500	204€					Ø450	665-ZUWA260450	21.16€
Ø500	665-ZUWA9390550	691€	Ø500	665-ZUWA9380550	539€	Ø500	665-ZUWA9870550	221€					Ø500	665-ZUWA260500	24.4€
Ø550	665-ZUWA9390600	775€	Ø550	665-ZUWA9380600	606€	Ø550	665-ZUWA9870600	244€					Ø550	665-ZUWA260550	27.67€
Ø600	665-ZUWA9390650	869€	Ø600	665-ZUWA9380650	684€	Ø600	665-ZUWA9870650	271€					Ø600	665-ZUWA260600	30.9€
Ø650	665-ZUWA9390715	1006€	Ø650	665-ZUWA9380715	789€	Ø650	665-ZUWA9870715	367€					Ø650	665-ZUWA260650	35.77€
Ø700	665-ZUWA9390765	1057€	Ø700	665-ZUWA9380765	832€	Ø700	665-ZUWA9870765	433€					Ø700	665-ZUWA260700	40.87€
Ø750	665-ZUWA9390815	1115€	Ø750	665-ZUWA9380815	880€	Ø750	665-ZUWA9870815	483€					Ø750	665-ZUWA260750	45.58€
Ø800	665-ZUWA9390865	1168€	Ø800	665-ZUWA9380865	920€	Ø800	665-ZUWA9870865	504€					Ø800	665-ZUWA260800	48.72€

## ADAPTADOR CALDERA HEMBRA

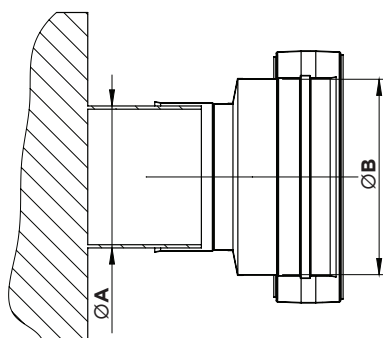

CÓDIGO	Ø A	Ø B	€
660-DWECO37H01800250	Ø180	Ø250	139€
660-DWECO37H02000250	Ø200	Ø250	140€
660-DWECO37H02000300	Ø200	Ø300	188€
660-DWECO37H02250250	Ø225	Ø250	140€
660-DWECO37H02250300	Ø225	Ø300	190€
660-DWECO37H02500250	Ø250	Ø250	97€
660-DWECO37H02500300	Ø250	Ø300	190€
660-DWECO37H02500350	Ø250	Ø350	233€
660-DWECO37H03000250	Ø300	Ø250	170€
660-DWECO37H03000300	Ø300	Ø300	122€
660-DWECO37H03000350	Ø300	Ø350	234€
660-DWECO37H03000400	Ø300	Ø400	271€
660-DWECO37H03500250	Ø350	Ø250	185€
660-DWECO37H03500300	Ø350	Ø300	211€
660-DWECO37H03500350	Ø350	Ø350	155€
660-DWECO37H03500400	Ø350	Ø400	275€
660-DWECO37H03500450	Ø350	Ø450	313€
660-DWECO37H04000300	Ø400	Ø300	227€
660-DWECO37H04000350	Ø400	Ø350	254€
660-DWECO37H04000400	Ø400	Ø400	190€
660-DWECO37H04000450	Ø400	Ø450	316€
660-DWECO37H04000500	Ø400	Ø500	335€
660-DWECO37H04500350	Ø450	Ø350	321€
660-DWECO37H04500400	Ø450	Ø400	334€
660-DWECO37H04500450	Ø450	Ø450	206€

660-DWECO37H04500500	Ø450	Ø500	338€
660-DWECO37H04500550	Ø450	Ø550	457€
660-DWECO37H05000400	Ø500	Ø400	337€
660-DWECO37H05000450	Ø500	Ø450	321€
660-DWECO37H05000500	Ø500	Ø500	222€
660-DWECO37H05000550	Ø500	Ø550	458€
660-DWECO37H05000600	Ø500	Ø600	462€
660-DWECO37H05500450	Ø550	Ø450	406€
660-DWECO37H05500500	Ø550	Ø500	428€
660-DWECO37H05500550	Ø550	Ø550	280€
660-DWECO37H05500600	Ø550	Ø600	466€
660-DWECO37H05500650	Ø550	Ø650	503€
660-DWECO37H06000500	Ø600	Ø500	439€
660-DWECO37H06000550	Ø600	Ø550	471€
660-DWECO37H06000600	Ø600	Ø600	289€
660-DWECO37H06000650	Ø600	Ø650	504€
660-DWECO37H06000700	Ø600	Ø700	541€
660-DWECO37H06500650	Ø650	Ø650	313€
660-DWECO37H06500700	Ø650	Ø700	542€
660-DWECO37H06500750	Ø650	Ø750	580€
660-DWECO37H07000700	Ø700	Ø700	335€
660-DWECO37H07000750	Ø700	Ø750	584€
660-DWECO37H07000800	Ø700	Ø800	620€
660-DWECO37H07500750	Ø750	Ø750	363€
660-DWECO37H07500800	Ø750	Ø800	621€
660-DWECO37H08000800	Ø800	Ø800	386€



# CHIMENEA INDIVIDUAL

## Sistema DW - ECO 2.0 304

### AMPLIACIONES

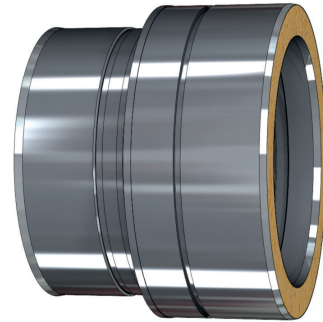
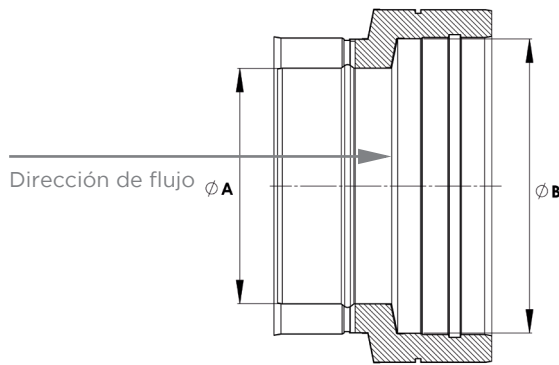

CÓDIGO	$\varnothing A$	$\varnothing B$	€
660-DWECO A01000250	$\varnothing 100$	$\varnothing 250$	356€
660-DWECO A01300250	$\varnothing 130$	$\varnothing 250$	337€
660-DWECO A01300300	$\varnothing 130$	$\varnothing 300$	410€
660-DWECO A01500250	$\varnothing 150$	$\varnothing 250$	327€
660-DWECO A01500300	$\varnothing 150$	$\varnothing 300$	390€
660-DWECO A01500350	$\varnothing 150$	$\varnothing 350$	483€
660-DWECO A01800250	$\varnothing 180$	$\varnothing 250$	311€
660-DWECO A01800300	$\varnothing 180$	$\varnothing 300$	370€
660-DWECO A01800350	$\varnothing 180$	$\varnothing 350$	462€
660-DWECO A01800400	$\varnothing 180$	$\varnothing 400$	595€
660-DWECO A02000250	$\varnothing 200$	$\varnothing 250$	283€
660-DWECO A02000300	$\varnothing 200$	$\varnothing 300$	358€
660-DWECO A02000350	$\varnothing 200$	$\varnothing 350$	447€
660-DWECO A02000400	$\varnothing 200$	$\varnothing 400$	570€
660-DWECO A02000450	$\varnothing 200$	$\varnothing 450$	806€
660-DWECO A02500300	$\varnothing 250$	$\varnothing 300$	327€
660-DWECO A02500350	$\varnothing 250$	$\varnothing 350$	425€
660-DWECO A02500400	$\varnothing 250$	$\varnothing 400$	544€
660-DWECO A02500450	$\varnothing 250$	$\varnothing 450$	775€
660-DWECO A02500500	$\varnothing 250$	$\varnothing 500$	916€
660-DWECO A03000350	$\varnothing 300$	$\varnothing 350$	387€
660-DWECO A03000400	$\varnothing 300$	$\varnothing 400$	521€
660-DWECO A03000450	$\varnothing 300$	$\varnothing 450$	744€
660-DWECO A03000500	$\varnothing 300$	$\varnothing 500$	876€
660-DWECO A03000550	$\varnothing 300$	$\varnothing 550$	967€
660-DWECO A03500400	$\varnothing 350$	$\varnothing 400$	473€
660-DWECO A03500450	$\varnothing 350$	$\varnothing 450$	709€
660-DWECO A03500500	$\varnothing 350$	$\varnothing 500$	840€
660-DWECO A03500550	$\varnothing 350$	$\varnothing 550$	930€
660-DWECO A03500600	$\varnothing 350$	$\varnothing 600$	1182€

660-DWECO A04000450	$\varnothing 400$	$\varnothing 450$	648€
660-DWECO A04000500	$\varnothing 400$	$\varnothing 500$	803€
660-DWECO A04000550	$\varnothing 400$	$\varnothing 550$	888€
660-DWECO A04000600	$\varnothing 400$	$\varnothing 600$	1134€
660-DWECO A04000650	$\varnothing 400$	$\varnothing 650$	1482€
660-DWECO A04500500	$\varnothing 450$	$\varnothing 500$	731€
660-DWECO A04500550	$\varnothing 450$	$\varnothing 550$	852€
660-DWECO A04500600	$\varnothing 450$	$\varnothing 600$	1088€
660-DWECO A04500650	$\varnothing 450$	$\varnothing 650$	1420€
660-DWECO A04500700	$\varnothing 450$	$\varnothing 700$	1552€
660-DWECO A05000550	$\varnothing 500$	$\varnothing 550$	775€
660-DWECO A05000600	$\varnothing 500$	$\varnothing 600$	1040€
660-DWECO A05000650	$\varnothing 500$	$\varnothing 650$	1360€
660-DWECO A05000700	$\varnothing 500$	$\varnothing 700$	1489€
660-DWECO A05000750	$\varnothing 500$	$\varnothing 750$	1648€
660-DWECO A05500600	$\varnothing 550$	$\varnothing 600$	948€
660-DWECO A05500650	$\varnothing 550$	$\varnothing 650$	1300€
660-DWECO A05500700	$\varnothing 550$	$\varnothing 700$	1429€
660-DWECO A05500750	$\varnothing 550$	$\varnothing 750$	1581€
660-DWECO A05500800	$\varnothing 550$	$\varnothing 800$	1848€
660-DWECO A06000650	$\varnothing 600$	$\varnothing 650$	1182€
660-DWECO A06000700	$\varnothing 600$	$\varnothing 700$	1368€
660-DWECO A06000750	$\varnothing 600$	$\varnothing 750$	1517€
660-DWECO A06000800	$\varnothing 600$	$\varnothing 800$	1773€
660-DWECO A06500700	$\varnothing 650$	$\varnothing 700$	1242€
660-DWECO A06500750	$\varnothing 650$	$\varnothing 750$	1449€
660-DWECO A06500800	$\varnothing 650$	$\varnothing 800$	1698€
660-DWECO A07000750	$\varnothing 700$	$\varnothing 750$	1317€
660-DWECO A07000800	$\varnothing 700$	$\varnothing 800$	1624€
660-DWECO A07500800	$\varnothing 750$	$\varnothing 800$	1478€

## REDUCCIONES

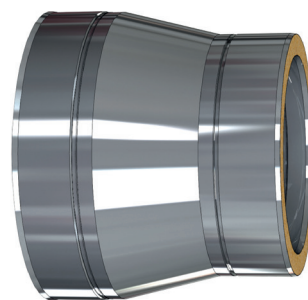
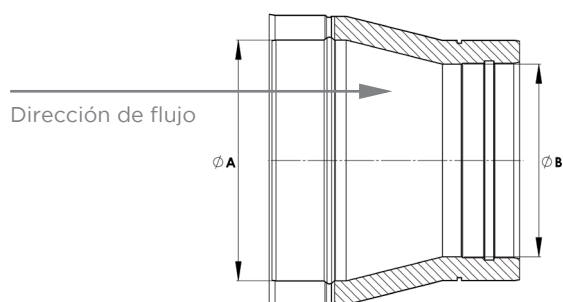

CÓDIGO	Ø A	Ø B	€
660-DWECOR03000250	Ø300	Ø250	<b>327€</b>
660-DWECOR03500250	Ø350	Ø250	<b>425€</b>
660-DWECOR03500300	Ø350	Ø300	<b>387€</b>
660-DWECOR04000250	Ø400	Ø250	<b>544€</b>
660-DWECOR04000300	Ø400	Ø300	<b>521€</b>
660-DWECOR04000350	Ø400	Ø350	<b>473€</b>
660-DWECOR04500250	Ø450	Ø250	<b>775€</b>
660-DWECOR04500300	Ø450	Ø300	<b>744€</b>
660-DWECOR04500350	Ø450	Ø350	<b>709€</b>
660-DWECOR04500400	Ø450	Ø400	<b>648€</b>
660-DWECOR05000250	Ø500	Ø250	<b>916€</b>
660-DWECOR05000300	Ø500	Ø300	<b>876€</b>
660-DWECOR05000350	Ø500	Ø350	<b>840€</b>
660-DWECOR05000400	Ø500	Ø400	<b>803€</b>
660-DWECOR05000450	Ø500	Ø450	<b>731€</b>
660-DWECOR05500300	Ø550	Ø300	<b>967€</b>
660-DWECOR05500350	Ø550	Ø350	<b>930€</b>
660-DWECOR05500400	Ø550	Ø400	<b>888€</b>
660-DWECOR05500450	Ø550	Ø450	<b>852€</b>
660-DWECOR05500500	Ø550	Ø500	<b>775€</b>
660-DWECOR06000350	Ø600	Ø350	<b>1182€</b>
660-DWECOR06000400	Ø600	Ø400	<b>1134€</b>

660-DWECOR06000450	Ø600	Ø450	<b>1088€</b>
660-DWECOR06000500	Ø600	Ø500	<b>1040€</b>
660-DWECOR06000550	Ø600	Ø550	<b>948€</b>
660-DWECOR06500400	Ø650	Ø400	<b>1482€</b>
660-DWECOR06500450	Ø650	Ø450	<b>1420€</b>
660-DWECOR06500500	Ø650	Ø500	<b>1360€</b>
660-DWECOR06500550	Ø650	Ø550	<b>1300€</b>
660-DWECOR06500600	Ø650	Ø600	<b>1182€</b>
660-DWECOR07000450	Ø700	Ø450	<b>1552€</b>
660-DWECOR07000500	Ø700	Ø500	<b>1489€</b>
660-DWECOR07000550	Ø700	Ø550	<b>1429€</b>
660-DWECOR07000600	Ø700	Ø600	<b>1368€</b>
660-DWECOR07000650	Ø700	Ø650	<b>1242€</b>
660-DWECOR07500500	Ø750	Ø500	<b>1648€</b>
660-DWECOR07500550	Ø750	Ø550	<b>1581€</b>
660-DWECOR07500600	Ø750	Ø600	<b>1517€</b>
660-DWECOR07500650	Ø750	Ø650	<b>1449€</b>
660-DWECOR07500700	Ø750	Ø700	<b>1317€</b>
660-DWECOR08000550	Ø800	Ø550	<b>1848€</b>
660-DWECOR08000600	Ø800	Ø600	<b>1773€</b>
660-DWECOR08000650	Ø800	Ø650	<b>1698€</b>
660-DWECOR08000700	Ø800	Ø700	<b>1624€</b>
660-DWECOR08000750	Ø800	Ø750	<b>1478€</b>



# CHIMENEA INDIVIDUAL

## Sistema DW - ECO 1.0 316

**Chimenea modular metálica para evacuación de humos y gases de los productos de la combustión de doble pared fabricada en acero inoxidable interior y exterior.**

### MATERIAL

Pared Interior: AISI 316L  
Pared Exterior: AISI 304

### ACABADO EXTERIOR

Brillante  
Colores RAL (consulta página 14 para acabados especiales)  
Exterior galvanizado -15% (sólo tramos rectos y desviaciones)

### AISLAMIENTO

Lana de roca rígida de alta densidad (120kg/m<sup>3</sup>)

### ESPESORES (mm)

Pared interior: 0,4 mm  
Aislamiento: 25 mm  
Pared exterior: 0,4 mm

### DIÁMETROS DISPONIBLES (mm)

Ø80 a Ø200

### SISTEMA DE UNIÓN

Conexión macho-hembra con **abrazadera de unión sencilla**

### NIVEL DE ESTANQUEIDAD

Txxx - N1: Sin necesidad de junta  
T120 - H1: Incluir junta de condensación (DW2526CØ)\*.  
T200 - H1: Incluir junta de estanqueidad (DW2526Ø)\*.

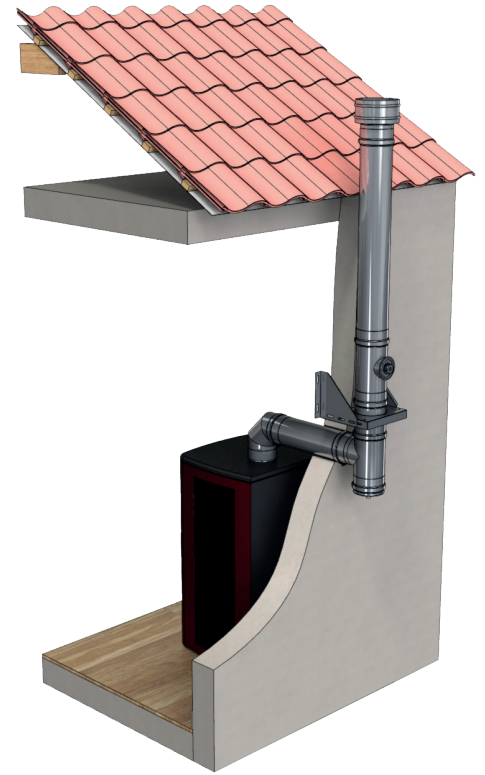

Para incluir la junta de condensación (T<120°C) preinstalada de fábrica, sustituir el código del sistema 909 por B11\*.  
Para incluir la junta de estanqueidad (T<200°C) preinstalada de fábrica, sustituir el código del sistema 909 por B01\*.  
Excepto terminales



## APLICACIONES

- Calderas de condensación
- Calderas y estufas de combustibles sólidos
- Fuegos bajos
- Hornos
- Cocinas de leña



## CARACTERÍSTICAS

- Temperatura de trabajo hasta 600°C
- **Soldadura TIG/LÁSER** en continuo en todas las piezas
- **Abrazadera de unión incluida (excepto terminales)**
- Posibilidad de **corte de módulos rectos a medida** en obra (ver instrucciones de corte página 53)
- **Para condensación es necesaria la junta de condensación (DW2526C) en las uniones y una pendiente mínima de 3° en tramos horizontales (T<120°C)**
- Chimenea con clasificación de **resistencia al fuego**

### CERTIFICADO CE

0036 CPR 9174 030  
0036 CPR 9174 044

### CLASIFICACIONES CE (UNE-EN 1856-1)

T600 - N1 - D - V3 - L50040 - G(70)  
T450 - N1 - D - V3 - L50040 - G(60)  
T400 - N1 - W - V2 - L50040 - O(30)  
T200 - H1 - W - V2 - L50040 - O(20) (con junta de estanqueidad DW2526)  
T120 - H1 - W - V2 - L50040 - O(00) (con junta de condensación DW2526C)

### CLASIFICACIONES DE RESISTENCIA AL FUEGO SEGÚN EN 13501-2

EI180 ve (o-->i) T200  
EI120 ve (o-->i) T600  
EI120 ho (o-->i) T600



Módulo recto 1000mm



Módulo recto 500mm



Módulo recto 250mm



Módulo recto 250mm con  
desagüe lateral



Módulo recto regulable  
400-560mm

Ø80	909-DWECO130080	157	Ø80	909-DWECO140080	111€	Ø80	909-DWECO150080	81€	Ø80	909-DWECO15D0080	112€	Ø80	909-DWECO5440080	157€
Ø100	909-DWECO130100	163	Ø100	909-DWECO140100	119€	Ø100	909-DWECO150100	84€	Ø100	909-DWECO15D0100	122€	Ø100	909-DWECO5440100	163€
Ø130	909-DWECO130130	169	Ø130	909-DWECO140130	122€	Ø130	909-DWECO150130	87€	Ø130	909-DWECO15D0130	131€	Ø130	909-DWECO5440130	169€
Ø150	909-DWECO130150	188	Ø150	909-DWECO140150	139€	Ø150	909-DWECO150150	96€	Ø150	909-DWECO15D0150	140€	Ø150	909-DWECO5440150	187€
Ø180	909-DWECO130180	227	Ø180	909-DWECO140180	163€	Ø180	909-DWECO150180	110€	Ø180	909-DWECO15D0180	160€	Ø180	909-DWECO5440180	219€
Ø200	909-DWECO130200	268	Ø200	909-DWECO140200	190€	Ø200	909-DWECO150200	129€	Ø200	909-DWECO15D0200	177€	Ø200	909-DWECO5440200	251€



Módulo recto regulable  
560-920mm



Codo 15°



Codo 30°



Codo 45°



Codo 60°

Ø80	909-DWECO5450080	236€	Ø80	909-DWECO160080	111€	Ø80	909-DWECO170080	111€	Ø80	909-DWECO180080	111€	Ø80	909-DWECO840080	139€
Ø100	909-DWECO5450100	245€	Ø100	909-DWECO160100	119€	Ø100	909-DWECO170100	119€	Ø100	909-DWECO180100	119€	Ø100	909-DWECO840100	143€
Ø130	909-DWECO5450130	251€	Ø130	909-DWECO160130	122€	Ø130	909-DWECO170130	122€	Ø130	909-DWECO180130	122€	Ø130	909-DWECO840130	150€
Ø150	909-DWECO5450150	280€	Ø150	909-DWECO160150	137€	Ø150	909-DWECO170150	137€	Ø150	909-DWECO180150	137€	Ø150	909-DWECO840150	166€
Ø180	909-DWECO5450180	329€	Ø180	909-DWECO160180	157€	Ø180	909-DWECO170180	157€	Ø180	909-DWECO180180	157€	Ø180	909-DWECO840180	191€
Ø200	909-DWECO5450200	378€	Ø200	909-DWECO160200	183€	Ø200	909-DWECO170200	183€	Ø200	909-DWECO180200	183€	Ø200	909-DWECO840200	220€

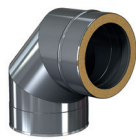

Codo 87°

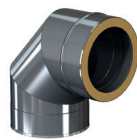

Codo 90°



Te 87°



Te 90°



Te 135°

Ø80	909-DWECO640080	161€	Ø80	909-DWECO600080	161€	Ø80	909-DWECO110080	274€	Ø80	909-DWECO3170080	235€	Ø80	909-DWECO120080	334€
Ø100	909-DWECO640100	169€	Ø100	909-DWECO600100	169€	Ø100	909-DWECO110100	287€	Ø100	909-DWECO3170100	244€	Ø100	909-DWECO120100	348€
Ø130	909-DWECO640130	172€	Ø130	909-DWECO600130	172€	Ø130	909-DWECO110130	297€	Ø130	909-DWECO3170130	250€	Ø130	909-DWECO120130	361€
Ø150	909-DWECO640150	196€	Ø150	909-DWECO600150	196€	Ø150	909-DWECO110150	330€	Ø150	909-DWECO3170150	271€	Ø150	909-DWECO120150	401€
Ø180	909-DWECO640180	222€	Ø180	909-DWECO600180	222€	Ø180	909-DWECO110180	384€	Ø180	909-DWECO3170180	319€	Ø180	909-DWECO120180	468€
Ø200	909-DWECO640200	260€	Ø200	909-DWECO600200	260€	Ø200	909-DWECO110200	447€	Ø200	909-DWECO3170200	370€	Ø200	909-DWECO120200	555€



# CHIMENEA INDIVIDUAL

## Sistema DW - ECO 1.0 316



Te pellets

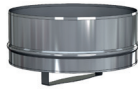

Colector de hollín



Colector de hollín aislado

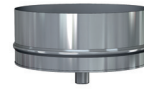

Colector de hollín con desagüe

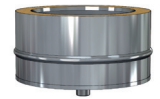

Colector de hollín con desagüe aislado

Ø80	909-DWECO12970080	180€	Ø80	909-DWECO5510080	42.42€	Ø80	909-DWECO20330080	66€	Ø80	909-DWECO440080	52€	Ø80	909-DWECO14600080	83€
Ø100	909-DWECO12970100	185€	Ø100	909-DWECO5510100	45.58€	Ø100	909-DWECO20330100	76€	Ø100	909-DWECO440100	54€	Ø100	909-DWECO14600100	91€
			Ø130	909-DWECO5510130	54€	Ø130	909-DWECO20330130	84€	Ø130	909-DWECO440130	65€	Ø130	909-DWECO14600130	99€
			Ø150	909-DWECO5510150	62€	Ø150	909-DWECO20330150	97€	Ø150	909-DWECO440150	74€	Ø150	909-DWECO14600150	111€
			Ø180	909-DWECO5510180	67€	Ø180	909-DWECO20330180	110€	Ø180	909-DWECO440180	78€	Ø180	909-DWECO14600180	127€
			Ø200	909-DWECO5510200	76€	Ø200	909-DWECO20330200	123€	Ø200	909-DWECO440200	87€	Ø200	909-DWECO14600200	141€

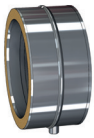

Colector de hollín con desagüe lateral

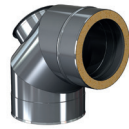

Codo 87° con inspección P1

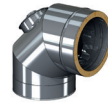

Codo 90° con tapa de inspección P1



Módulo de inspección



Módulo de inspección con tapa 200 Pa (P1)

Ø80	909-DWECO10080	121€	Ø80	909-DWECO67AL0080	317€	Ø80	909-DWECO19AL0080	317€	Ø80	909-DWECO5430080	137€	Ø80	909-DWECO5490080	218€
Ø100	909-DWECO10100	131€	Ø100	909-DWECO67AL0100	328€	Ø100	909-DWECO19AL0100	328€	Ø100	909-DWECO5430100	140€	Ø100	909-DWECO5490100	239€
Ø130	909-DWECO10130	143€	Ø130	909-DWECO67AL0130	338€	Ø130	909-DWECO19AL0130	338€	Ø130	909-DWECO5430130	143€	Ø130	909-DWECO5490130	250€
Ø150	909-DWECO10150	155€	Ø150	909-DWECO67AL0150	352€	Ø150	909-DWECO19AL0150	352€	Ø150	909-DWECO5430150	161€	Ø150	909-DWECO5490150	261€
Ø180	909-DWECO10180	170€	Ø180	909-DWECO67AL0180	411€	Ø180	909-DWECO19AL0180	411€	Ø180	909-DWECO5430180	187€	Ø180	909-DWECO5490180	274€
Ø200	909-DWECO10200	183€	Ø200	909-DWECO67AL0200	441€	Ø200	909-DWECO19AL0200	441€	Ø200	909-DWECO5430200	215€	Ø200	909-DWECO5490200	288€



Módulo de inspección con tapa 40 Pa (N1)



Módulo temperatura humos

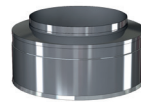

Terminal salida libre

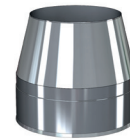

Terminal salida cónica

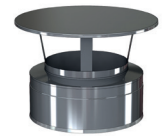

Terminal anti-lluvia

Ø80	909-DWECO680080	218€	Ø80	909-DWECO870080	555€	Ø80	909-DWECO320080	74€	Ø80	909-DWECO32C0080	84€	Ø80	909-DWECO5260080	100€
Ø100	909-DWECO680100	239€	Ø100	909-DWECO870100	577€	Ø100	909-DWECO320100	76€	Ø100	909-DWECO32C0100	87€	Ø100	909-DWECO5260100	106€
Ø130	909-DWECO680130	250€	Ø130	909-DWECO870130	596€	Ø130	909-DWECO320130	78€	Ø130	909-DWECO32C0130	90€	Ø130	909-DWECO5260130	109€
Ø150	909-DWECO680150	261€	Ø150	909-DWECO870150	664€	Ø150	909-DWECO320150	90€	Ø150	909-DWECO32C0150	100€	Ø150	909-DWECO5260150	122€
Ø180	909-DWECO680180	274€	Ø180	909-DWECO870180	758€	Ø180	909-DWECO320180	100€	Ø180	909-DWECO32C0180	117€	Ø180	909-DWECO5260180	141€
Ø200	909-DWECO680200	288€	Ø200	909-DWECO870200	822€	Ø200	909-DWECO320200	119€	Ø200	909-DWECO32C0200	137€	Ø200	909-DWECO5260200	163€



Consultar página 91 para ver distancias de separación.

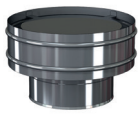

Terminal anti-viento

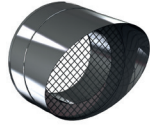

Terminal horizontal con rejilla



Terminal GAS light



Regulador de tiro



Estabilizador de tiro (adaptador + clapeta)

Ø80	909-DWECO5270080	146€	Ø80	909-DWECO5320080	95€	Ø80	909-DWECO4350080	220€	Ø80	909-DWECO5310080	236€	Ø80	909-DWECO9700080	244€
Ø100	909-DWECO5270100	152€	Ø100	909-DWECO5320100	95€	Ø100	909-DWECO4350100	235€	Ø100	909-DWECO5310100	245€	Ø100	909-DWECO9700100	256€
Ø130	909-DWECO5270130	157€	Ø130	909-DWECO5320130	97€	Ø130	909-DWECO4350130	256€	Ø130	909-DWECO5310130	251€	Ø130	909-DWECO9700130	269€
Ø150	909-DWECO5270150	173€	Ø150	909-DWECO5320150	109€	Ø150	909-DWECO4350150	289€	Ø150	909-DWECO5310150	280€	Ø150	909-DWECO9700150	344€
Ø180	909-DWECO5270180	205€	Ø180	909-DWECO5320180	129€	Ø180	909-DWECO4350180	316€	Ø180	909-DWECO5310180	329€	Ø180	909-DWECO9700180	380€
Ø200	909-DWECO5270200	236€	Ø200	909-DWECO5320200	150€	Ø200	909-DWECO4350200	352€	Ø200	909-DWECO5310200	378€	Ø200	909-DWECO9700200	400€

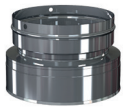

Adaptador a Hurricane

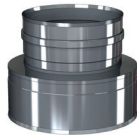

Adaptador doble a simple

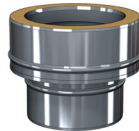

Adaptador simple a doble

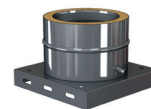

Placa base con desagüe lateral

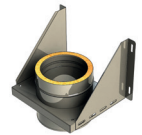

Soporte de carga regulable

Ø130	909-DWECO44760130	160€	Ø80	909-DWECO37A0080	50€	Ø80	909-DWECO370080	50€	Ø80	909-DWECO60080	222€	Ø80	909-DWECO3790080	204€
Ø150	909-DWECO44760150	185€	Ø100	909-DWECO37A0100	56€	Ø100	909-DWECO370100	56€	Ø100	909-DWECO60100	235€	Ø100	909-DWECO3790100	211€
Ø180	909-DWECO44760180	219€	Ø130	909-DWECO37A0130	56€	Ø130	909-DWECO370130	56€	Ø130	909-DWECO60130	242€	Ø130	909-DWECO3790130	215€
Ø200	909-DWECO44760200	235€	Ø150	909-DWECO37A0150	65€	Ø150	909-DWECO370150	65€	Ø150	909-DWECO60150	271€	Ø150	909-DWECO3790150	242€
			Ø180	909-DWECO37A0180	76€	Ø180	909-DWECO370180	76€	Ø180	909-DWECO60180	283€	Ø180	909-DWECO3790180	283€
			Ø200	909-DWECO37A0200	87€	Ø200	909-DWECO370200	87€	Ø200	909-DWECO60200	319€	Ø200	909-DWECO3790200	327€



Abrazadera de unión 1.0

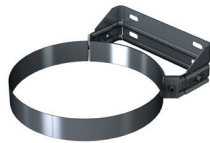

Abrazadera fijación pared regulable 50-80mm



Base de abrazadera distanciadora



Alas distanciadoras A



Alas distanciadoras B

Ø80	665-ZUWA450130	6.52€	Ø80	665-ZUWA5560130	37.43€	Ø80	665-ZUWA14620130	45.58€	Ø80	665-ZUWA1462A	47.13€	Ø80	665-ZUWA1462B	65€
Ø100	665-ZUWA450150	8.15€	Ø100	665-ZUWA5560150	39.04€	Ø100	665-ZUWA14620150	48.72€	Ø100	665-ZUWA1462A	47.13€	Ø100	665-ZUWA1462B	65€
Ø130	665-ZUWA450180	9.75€	Ø130	665-ZUWA5560180	39.04€	Ø130	665-ZUWA14620180	52€	Ø130	665-ZUWA1462A	47.13€	Ø130	665-ZUWA1462B	65€
Ø150	665-ZUWA450200	11.38€	Ø150	665-ZUWA5560200	45.58€	Ø150	665-ZUWA14620200	58€	Ø150	665-ZUWA1462A	47.13€	Ø150	665-ZUWA1462B	65€
Ø180	665-ZUWA450230	14.65€	Ø180	665-ZUWA5560230	52€	Ø180	665-ZUWA14620230	77€	Ø180	665-ZUWA1462A	47.13€	Ø180	665-ZUWA1462B	65€
Ø200	665-ZUWA450250	21.16€	Ø200	665-ZUWA5560250	61€	Ø200	665-ZUWA14620250	100€	Ø200	665-ZUWA1462A	47.13€	Ø200	665-ZUWA1462B	65€



# CHIMENEA INDIVIDUAL

## Sistema DW - ECO 1.0 316



Alas distanciadoras C



Alas distanciadoras D

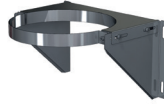

Abrazadera de soporte



Abrazadera con doble pértiga telescópica L=2000mm



Abrazadera fijacion a techo

Ø80	665-ZUWA1462C	81€	Ø80	665-ZUWA1462D	104€	Ø130	665-ZUWA8580180	145€	Ø80	665-ZUWA1910130	144€	Ø80	665-ZUWA118B0130	39.04€
Ø100	665-ZUWA1462C	81€	Ø100	665-ZUWA1462D	104€	Ø150	665-ZUWA8580200	145€	Ø100	665-ZUWA1910150	146€	Ø100	665-ZUWA118B0150	42.42€
Ø130	665-ZUWA1462C	81€	Ø130	665-ZUWA1462D	104€	Ø180	665-ZUWA8580230	163€	Ø130	665-ZUWA1910180	156€	Ø130	665-ZUWA118B0180	48.72€
Ø150	665-ZUWA1462C	81€	Ø150	665-ZUWA1462D	104€	Ø200	665-ZUWA8580250	185€	Ø150	665-ZUWA1910200	173€	Ø150	665-ZUWA118B0200	59€
Ø180	665-ZUWA1462C	81€	Ø180	665-ZUWA1462D	104€				Ø180	665-ZUWA1910230	179€	Ø180	665-ZUWA118B0230	66€
Ø200	665-ZUWA1462C	81€	Ø200	665-ZUWA1462D	104€				Ø200	665-ZUWA1910250	196€	Ø200	665-ZUWA118B0250	66€



Abrazadera forjado inox



Abrazadera para amarre por tornillo



Abrazadera vientos



Soporte de techo



Collarín antitormenta

Ø80	665-ZUWA620130	26.04€	Ø80	665-ZUWA10630130	32.52€	Ø80	665-ZUWA420130	11.38€	Ø80	665-ZUWA9360130	34.15€	Ø80	665-ZUWA3070130	29.27€
Ø100	665-ZUWA620150	30.9€	Ø100	665-ZUWA10630150	35.77€	Ø100	665-ZUWA420150	14.65€	Ø100	665-ZUWA9360150	40.87€	Ø100	665-ZUWA3070150	34.15€
Ø130	665-ZUWA620180	42.42€	Ø130	665-ZUWA10630180	39.04€	Ø130	665-ZUWA420180	21.16€	Ø130	665-ZUWA9360180	50€	Ø130	665-ZUWA3070180	40.87€
Ø150	665-ZUWA620200	47.13€	Ø150	665-ZUWA10630200	42.42€	Ø150	665-ZUWA420200	26.04€	Ø150	665-ZUWA9360200	56€	Ø150	665-ZUWA3070200	47.13€
Ø180	665-ZUWA620230	50€	Ø180	665-ZUWA10630230	50€	Ø180	665-ZUWA420230	27.67€	Ø180	665-ZUWA9360230	65€	Ø180	665-ZUWA3070230	52€
Ø200	665-ZUWA620250	50€	Ø200	665-ZUWA10630250	50€	Ø200	665-ZUWA420250	29.27€	Ø200	665-ZUWA9360250	73€	Ø200	665-ZUWA3070250	59€

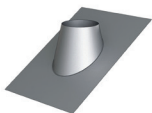

Cubreaguas 25°-45° aluminio

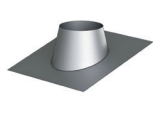

Cubreaguas 5°-25° aluminio

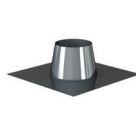

Cubreaguas plano inox

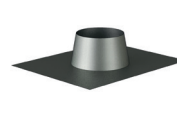

Cubreaguas plomo 0°-5°

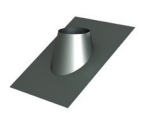

Cubreaguas plomo 25°-45°



Ø80	665-ZUWA939AL0130	219€	Ø80	665-ZUWA938AL0130	206€	Ø80	665-ZUWA11280130	146€	Ø80	665-ZUWA9370130	205€	Ø80	665-ZUWA9390130	358€
Ø100	665-ZUWA939AL0150	233€	Ø100	665-ZUWA938AL0150	215€	Ø100	665-ZUWA11280150	150€	Ø100	665-ZUWA9370150	206€	Ø100	665-ZUWA9390150	363€
Ø130	665-ZUWA939AL0180	250€	Ø130	665-ZUWA938AL0180	235€	Ø130	665-ZUWA11280180	170€	Ø130	665-ZUWA9370180	234€	Ø130	665-ZUWA9390180	379€
Ø150	665-ZUWA939AL0200	269€	Ø150	665-ZUWA938AL0200	252€	Ø150	665-ZUWA11280200	185€	Ø150	665-ZUWA9370200	260€	Ø150	665-ZUWA9390200	386€
Ø180	665-ZUWA939AL0230	288€	Ø180	665-ZUWA938AL0230	261€	Ø180	665-ZUWA11280230	191€	Ø180	665-ZUWA9370230	269€	Ø180	665-ZUWA9390230	397€
Ø200	665-ZUWA939AL0250	305€	Ø200	665-ZUWA938AL0250	282€	Ø200	665-ZUWA11280250	211€	Ø200	665-ZUWA9370250	294€	Ø200	665-ZUWA9390250	401€

- i** Precio unidad. u./c= unidad caja.
- i** Necesario instalar collarín con el cubreaguas.
- i** Consultar página 91 para ver distancias de separación.

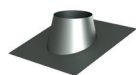

Cubreaguas plomo 5°-25°



Pasamuros



Soporte cubierta ventilado



Junta de silicona  
(T<200°C)



Junta EPDM (T<120°C)

Ø80	665-ZUWA9380130	205€	Ø80	665-ZUWA9870130	39.04€	Ø80	665-ZUWA9340130	64€	Ø80	665-ZUWA260080	4.88€	Ø80	665-ZUWA26C0080	4.88€
Ø100	665-ZUWA9380150	206€	Ø100	665-ZUWA9870150	40.87€	Ø100	665-ZUWA9340150	67€	Ø100	665-ZUWA260100	4.88€	Ø100	665-ZUWA26C0100	4.88€
Ø130	665-ZUWA9380180	234€	Ø130	665-ZUWA9870180	52€	Ø130	665-ZUWA9340180	71€	Ø130	665-ZUWA260130	4.88€	Ø130	665-ZUWA26C0130	4.88€
Ø150	665-ZUWA9380200	260€	Ø150	665-ZUWA9870200	52€	Ø150	665-ZUWA9340200	78€	Ø150	665-ZUWA260150	4.88€	Ø150	665-ZUWA26C0150	4.88€
Ø180	665-ZUWA9380230	269€	Ø180	665-ZUWA9870230	64€	Ø180	665-ZUWA9340230	95€	Ø180	665-ZUWA260180	6.52€	Ø180	665-ZUWA26C0180	6.52€
Ø200	665-ZUWA9380250	294€	Ø200	665-ZUWA9870250	65€	Ø200	665-ZUWA9340250	107€	Ø200	665-ZUWA260200	8.15€	Ø200	665-ZUWA26C0200	8.15€

## ADAPTADOR CALDERA HEMBRA

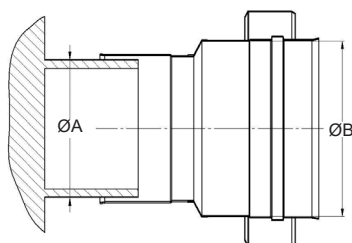

CÓDIGO	Ø A	Ø B	€
909-DWECO37H00800080	Ø80	Ø80	58€
909-DWECO37H00800130	Ø80	Ø130	84€
909-DWECO37H01000080	Ø100	Ø80	90€
909-DWECO37H01000100	Ø100	Ø100	61€
909-DWECO37H01000130	Ø100	Ø130	87€
909-DWECO37H01000150	Ø100	Ø150	98€
909-DWECO37H01100080	Ø110	Ø80	90€
909-DWECO37H01100100	Ø110	Ø100	91€
909-DWECO37H01100130	Ø110	Ø130	87€
909-DWECO37H01100150	Ø110	Ø150	98€
909-DWECO37H01200080	Ø120	Ø80	91€
909-DWECO37H01200100	Ø120	Ø100	91€
909-DWECO37H01200130	Ø120	Ø130	87€
909-DWECO37H01200150	Ø120	Ø150	98€
909-DWECO37H01250080	Ø125	Ø80	91€
909-DWECO37H01250100	Ø125	Ø100	91€
909-DWECO37H01250130	Ø125	Ø130	61€
909-DWECO37H01250150	Ø125	Ø150	98€
909-DWECO37H01300080	Ø130	Ø80	91€
909-DWECO37H01300100	Ø130	Ø100	91€
909-DWECO37H01300130	Ø130	Ø130	61€
909-DWECO37H01300150	Ø130	Ø150	99€
909-DWECO37H01300180	Ø130	Ø180	121€
909-DWECO37H01350100	Ø135	Ø100	100€
909-DWECO37H01350130	Ø135	Ø130	61€
909-DWECO37H01350150	Ø135	Ø150	99€
909-DWECO37H01350180	Ø135	Ø180	121€

909-DWECO37H01400100	Ø140	Ø100	100€
909-DWECO37H01400130	Ø140	Ø130	98€
909-DWECO37H01400150	Ø140	Ø150	67€
909-DWECO37H01400180	Ø140	Ø180	122€
909-DWECO37H01500100	Ø150	Ø100	100€
909-DWECO37H01500130	Ø150	Ø130	98€
909-DWECO37H01500150	Ø150	Ø150	67€
909-DWECO37H01500180	Ø150	Ø180	122€
909-DWECO37H01500200	Ø150	Ø200	139€
909-DWECO37H01600130	Ø160	Ø130	109€
909-DWECO37H01600150	Ø160	Ø150	67€
909-DWECO37H01600180	Ø160	Ø180	122€
909-DWECO37H01600200	Ø160	Ø200	139€
909-DWECO37H01750130	Ø175	Ø130	109€
909-DWECO37H01750150	Ø175	Ø150	111€
909-DWECO37H01750180	Ø175	Ø180	81€
909-DWECO37H01750200	Ø175	Ø200	139€
909-DWECO37H01800130	Ø180	Ø130	109€
909-DWECO37H01800150	Ø180	Ø150	111€
909-DWECO37H01800180	Ø180	Ø180	81€
909-DWECO37H01800200	Ø180	Ø200	140€
909-DWECO37H02000150	Ø200	Ø150	122€
909-DWECO37H02000180	Ø200	Ø180	133€
909-DWECO37H02000200	Ø200	Ø200	95€
909-DWECO37H02250180	Ø225	Ø180	133€
909-DWECO37H02250200	Ø225	Ø200	146€
909-DWECO37H02500180	Ø250	Ø180	133€
909-DWECO37H02500200	Ø250	Ø200	146€



# CHIMENEA INDIVIDUAL

## Sistema DW - ECO 1.0 316

### ADAPTADOR CALDERA MACHO

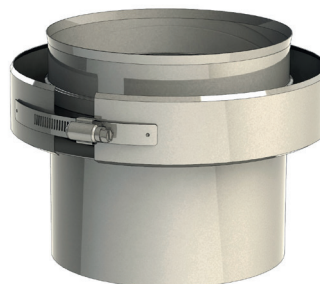
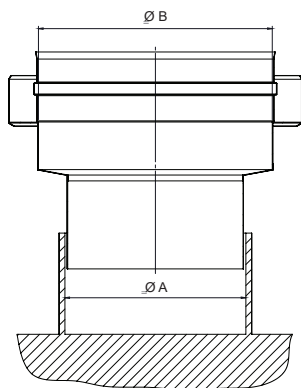

CÓDIGO	Ø A	Ø B	€
909-DWECO37M00800080	Ø80	Ø80	58€
909-DWECO37M00800100	Ø80	Ø100	87€
909-DWECO37M00800130	Ø80	Ø130	84€
909-DWECO37M01000080	Ø100	Ø80	90€
909-DWECO37M01000100	Ø100	Ø100	61€
909-DWECO37M01000130	Ø100	Ø130	87€
909-DWECO37M01000150	Ø100	Ø150	98€
909-DWECO37M01100080	Ø110	Ø80	90€
909-DWECO37M01100100	Ø110	Ø100	91€
909-DWECO37M01100130	Ø110	Ø130	87€
909-DWECO37M01100150	Ø110	Ø150	98€
909-DWECO37M01200080	Ø120	Ø80	91€
909-DWECO37M01200100	Ø120	Ø100	91€
909-DWECO37M01200130	Ø120	Ø130	87€
909-DWECO37M01200150	Ø120	Ø150	98€
909-DWECO37M01250080	Ø125	Ø80	91€
909-DWECO37M01250100	Ø125	Ø100	91€
909-DWECO37M01250130	Ø125	Ø130	61€
909-DWECO37M01250150	Ø125	Ø150	98€
909-DWECO37M01300080	Ø130	Ø80	91€
909-DWECO37M01300100	Ø130	Ø100	91€
909-DWECO37M01300130	Ø130	Ø130	61€
909-DWECO37M01300150	Ø130	Ø150	99€
909-DWECO37M01300180	Ø130	Ø180	121€
909-DWECO37M01350100	Ø135	Ø100	100€
909-DWECO37M01350130	Ø135	Ø130	61€
909-DWECO37M01350150	Ø135	Ø150	99€
909-DWECO37M01350180	Ø135	Ø180	121€

909-DWECO37M01400100	Ø140	Ø100	100€
909-DWECO37M01400130	Ø140	Ø130	98€
909-DWECO37M01400150	Ø140	Ø150	67€
909-DWECO37M01400180	Ø140	Ø180	122€
909-DWECO37M01500100	Ø150	Ø100	100€
909-DWECO37M01500130	Ø150	Ø130	98€
909-DWECO37M01500150	Ø150	Ø150	67€
909-DWECO37M01500180	Ø150	Ø180	122€
909-DWECO37M01500200	Ø150	Ø200	139€
909-DWECO37M01600130	Ø160	Ø130	109€
909-DWECO37M01600150	Ø160	Ø150	67€
909-DWECO37M01600180	Ø160	Ø180	122€
909-DWECO37M01600200	Ø160	Ø200	139€
909-DWECO37M01750130	Ø175	Ø130	109€
909-DWECO37M01750150	Ø175	Ø150	111€
909-DWECO37M01750180	Ø175	Ø180	81€
909-DWECO37M01750200	Ø175	Ø200	139€
909-DWECO37M01800130	Ø180	Ø130	109€
909-DWECO37M01800150	Ø180	Ø150	111€
909-DWECO37M01800180	Ø180	Ø180	81€
909-DWECO37M01800200	Ø180	Ø200	140€
909-DWECO37M02000150	Ø200	Ø150	122€
909-DWECO37M02000180	Ø200	Ø180	133€
909-DWECO37M02000200	Ø200	Ø200	95€
909-DWECO37M02250180	Ø225	Ø180	133€
909-DWECO37M02250200	Ø225	Ø200	146€
909-DWECO37M02500180	Ø250	Ø180	133€
909-DWECO37M02500200	Ø250	Ø200	146€

## AMPLIACIONES

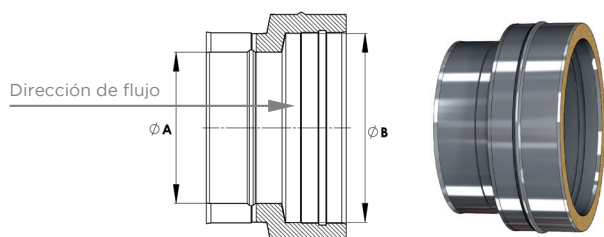

CÓDIGO	Ø A	Ø B	€
909-DWECOAX00800100	Ø80	Ø100	132€
909-DWECOAX00800130	Ø80	Ø130	187€
909-DWECOAX00800150	Ø80	Ø150	226€
909-DWECOAX00800180	Ø80	Ø180	275€
909-DWECOAX00800200	Ø80	Ø200	316€
909-DWECOAX01000130	Ø100	Ø130	170€
909-DWECOAX01000150	Ø100	Ø150	218€
909-DWECOAX01000180	Ø100	Ø180	266€
909-DWECOAX01000200	Ø100	Ø200	300€
909-DWECOAX01300150	Ø130	Ø150	199€
909-DWECOAX01300180	Ø130	Ø180	251€
909-DWECOAX01300200	Ø130	Ø200	289€
909-DWECOAX01500180	Ø150	Ø180	233€
909-DWECOAX01500200	Ø150	Ø200	274€
909-DWECOAX01800200	Ø180	Ø200	250€

## AMPLIACIONES EXCÉNTRICAS

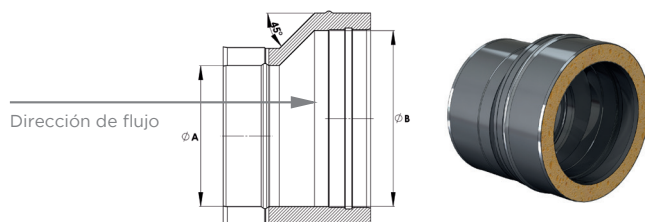

CÓDIGO	Ø A	Ø B	€
909-DWECOAX00800100	Ø80	Ø100	170€
909-DWECOAX00800130	Ø80	Ø130	244€
909-DWECOAX00800150	Ø80	Ø150	295€
909-DWECOAX00800180	Ø80	Ø180	361€
909-DWECOAX00800200	Ø80	Ø200	410€
909-DWECOAX01000130	Ø100	Ø130	220€
909-DWECOAX01000150	Ø100	Ø150	283€
909-DWECOAX01000180	Ø100	Ø180	341€
909-DWECOAX01000200	Ø100	Ø200	390€
909-DWECOAX01300150	Ø130	Ø150	254€
909-DWECOAX01300180	Ø130	Ø180	329€
909-DWECOAX01300200	Ø130	Ø200	370€
909-DWECOAX01500180	Ø150	Ø180	298€
909-DWECOAX01500200	Ø150	Ø200	358€
909-DWECOAX01800200	Ø180	Ø200	327€

## REDUCCIONES

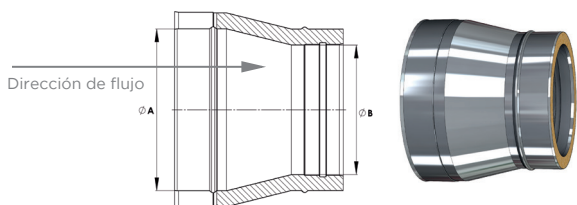

CÓDIGO	Ø A	Ø B	€
909-DWECOR01000080	Ø100	Ø80	132€
909-DWECOR01300080	Ø130	Ø80	187€
909-DWECOR01300100	Ø130	Ø100	170€
909-DWECOR01500080	Ø150	Ø80	226€
909-DWECOR01500100	Ø150	Ø100	218€
909-DWECOR01500130	Ø150	Ø130	199€
909-DWECOR01800080	Ø180	Ø80	275€
909-DWECOR01800100	Ø180	Ø100	266€
909-DWECOR01800130	Ø180	Ø130	251€
909-DWECOR01800150	Ø180	Ø150	233€
909-DWECOR02000080	Ø200	Ø80	316€
909-DWECOR02000100	Ø200	Ø100	300€
909-DWECOR02000130	Ø200	Ø130	289€
909-DWECOR02000150	Ø200	Ø150	274€
909-DWECOR02000180	Ø200	Ø180	250€

## REDUCCIONES EXCÉNTRICAS

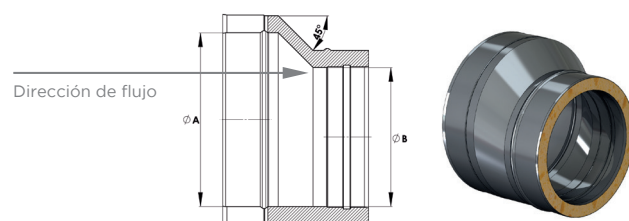

CÓDIGO	Ø A	Ø B	€
909-DWECORX01000080	Ø100	Ø80	170€
909-DWECORX01300080	Ø130	Ø80	244€
909-DWECORX01300100	Ø130	Ø100	220€
909-DWECORX01500080	Ø150	Ø80	295€
909-DWECORX01500100	Ø150	Ø100	283€
909-DWECORX01500130	Ø150	Ø130	254€
909-DWECORX01800080	Ø180	Ø80	361€
909-DWECORX01800100	Ø180	Ø100	341€
909-DWECORX01800130	Ø180	Ø130	329€
909-DWECORX01800150	Ø180	Ø150	298€
909-DWECORX02000080	Ø200	Ø80	410€
909-DWECORX02000100	Ø200	Ø100	390€
909-DWECORX02000130	Ø200	Ø130	370€
909-DWECORX02000150	Ø200	Ø150	358€
909-DWECORX02000180	Ø200	Ø180	327€



# CHIMENEA INDIVIDUAL

## Sistema DW - ECO 1.0 304

**Chimenea modular metálica para evacuación de humos y gases de los productos de la combustión de doble pared fabricada en acero inoxidable interior y exterior**

### MATERIAL

Pared Interior: AISI 304  
Pared Exterior: AISI 304

### ACABADO EXTERIOR

Brillante  
Colores RAL (consulta página 14 para acabados especiales)  
Exterior galvanizado -15% (sólo tramos rectos y desviaciones)

### AISLAMIENTO

Lana de roca rígida de alta densidad (120kg/m<sup>3</sup>)

### ESPESORES (mm)

Pared interior: 0,4 mm  
Aislamiento: 25 mm  
Pared exterior: 0,4 mm

### DIÁMETROS DISPONIBLES (mm)

Ø130 a Ø200

### SISTEMA DE UNIÓN

Conexión macho-hembra con **abrazadera de unión sencilla**

### NIVEL DE ESTANQUEIDAD

T--- N1: Sin necesidad de junta  
T200 - H1: Incluir junta de estanqueidad (DW2526Ø).

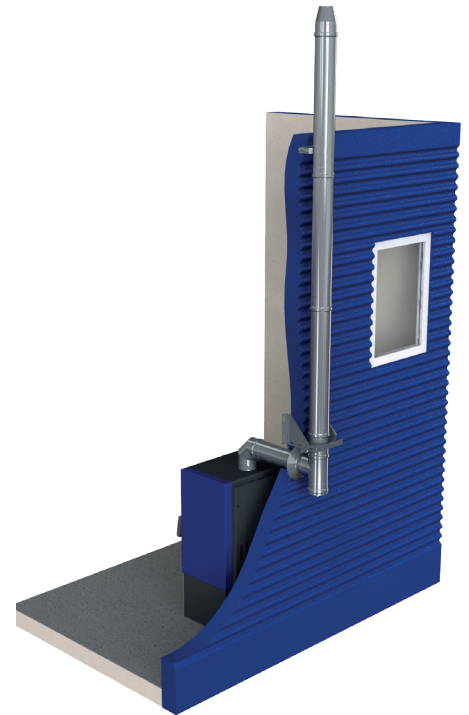

“Para incluir junta de estanqueidad (T<200°C) preinstalada de fábrica, sustituir el código 908 por A07 y el 909 por B01”.



### APLICACIONES

- Calderas de gas y gasoil
- No condensación



### CARACTERÍSTICAS

- Temperatura de trabajo hasta 600°C
- **Soldadura TIG/LÁSER** en continuo en todas las piezas
- **Abrazadera de unión incluida (excepto terminales)**
- Posibilidad de **corte de módulos rectos a medida** en obra (ver instrucciones de corte página 53)
- Chimenea con clasificación de **resistencia al fuego**

### CERTIFICADO CE

0036 CPR 9174 030  
0036 CPR 9174 044

### CLASIFICACIONES CE (UNE-EN 1856-1)

T600 - N1 - D - Vm - L20040 - G(70)  
T450 - N1 - D - Vm - L20040 - G(60)  
T400 - N1 - W - Vm - L20040 - O(30)  
T200 - H1 - W - Vm - L20040 - O(00) (con junta de estanqueidad DW2526).

### CLASIFICACIONES DE RESISTENCIA AL FUEGO SEGÚN EN 13501-2

EI180 ve (o-->i) T200  
EI120 ve (o-->i) T600  
EI120 ho (o-->i) T600



Módulo recto 1000mm



Módulo recto 500mm



Módulo recto 250mm



Módulo recto regulable  
400-560mm



Módulo recto regulable  
560-920mm

Ø130	908-DWECO130130	139€	Ø130	908-DWECO140130	99€	Ø130	908-DWECO150130	71€	Ø130	908-DWECO5440130	139€	Ø130	908-DWECO5450130	207€
Ø150	908-DWECO130150	170€	Ø150	908-DWECO140150	110€	Ø150	908-DWECO150150	80€	Ø150	908-DWECO5440150	156€	Ø150	908-DWECO5450150	234€
Ø180	908-DWECO130180	191€	Ø180	908-DWECO140180	132€	Ø180	908-DWECO150180	95€	Ø180	908-DWECO5440180	183€	Ø180	908-DWECO5450180	251€
Ø200	908-DWECO130200	226€	Ø200	908-DWECO140200	151€	Ø200	908-DWECO150200	106€	Ø200	908-DWECO5440200	210€	Ø200	908-DWECO5450200	287€



Codo 15°



Codo 30°



Codo 45°



Codo 60°

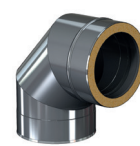

Codo 90°

Ø130	909-DWECO160130	122€	Ø130	909-DWECO170130	122€	Ø130	908-DWECO180130	99€	Ø130	909-DWECO840130	150€	Ø130	908-DWECO600130	141€
Ø150	909-DWECO160150	137€	Ø150	909-DWECO170150	137€	Ø150	908-DWECO180150	110€	Ø150	909-DWECO840150	166€	Ø150	908-DWECO600150	161€
Ø180	909-DWECO160180	157€	Ø180	909-DWECO170180	157€	Ø180	908-DWECO180180	132€	Ø180	909-DWECO840180	191€	Ø180	908-DWECO600180	185€
Ø200	909-DWECO160200	183€	Ø200	909-DWECO170200	183€	Ø200	908-DWECO180200	151€	Ø200	909-DWECO840200	220€	Ø200	908-DWECO600200	215€



Te 90°



Te 135°

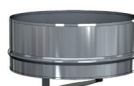

Colector de hollín



Colector de hollín aislado

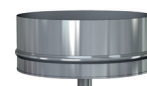

Colector de hollín con  
desagüe

Ø130	908-DWECO3170130	206€	Ø130	909-DWECO120130	361€	Ø130	909-DWECO5510130	54€	Ø130	909-DWECO20330130	84€	Ø130	909-DWECO440130	65€
Ø150	908-DWECO3170150	222€	Ø150	909-DWECO120150	401€	Ø150	909-DWECO5510150	62€	Ø150	909-DWECO20330150	97€	Ø150	909-DWECO440150	74€
Ø180	908-DWECO3170180	267€	Ø180	909-DWECO120180	468€	Ø180	909-DWECO5510180	67€	Ø180	909-DWECO20330180	110€	Ø180	909-DWECO440180	78€
Ø200	908-DWECO3170200	306€	Ø200	909-DWECO120200	555€	Ø200	909-DWECO5510200	76€	Ø200	909-DWECO20330200	123€	Ø200	909-DWECO440200	87€

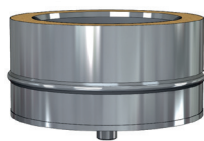

Colector de hollín con  
desagüe aislado



Módulo de inspección



Módulo de inspección con  
tapa 40 Pa (N1)

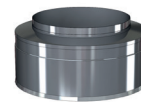

Terminal salida libre

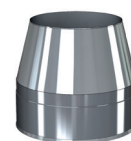

Terminal salida cónica

Ø130	909-DWECO14600130	99€	Ø130	909-DWECO5430130	143€	Ø130	909-DWECO680130	250€	Ø130	909-DWECO320130	78€	Ø130	909-DWECO32C0130	90€
Ø150	909-DWECO14600150	111€	Ø150	909-DWECO5430150	161€	Ø150	909-DWECO680150	261€	Ø150	909-DWECO320150	90€	Ø150	909-DWECO32C0150	100€
Ø180	909-DWECO14600180	127€	Ø180	909-DWECO5430180	187€	Ø180	909-DWECO680180	274€	Ø180	909-DWECO320180	100€	Ø180	909-DWECO32C0180	117€
Ø200	909-DWECO14600200	141€	Ø200	909-DWECO5430200	215€	Ø200	909-DWECO680200	288€	Ø200	909-DWECO320200	119€	Ø200	909-DWECO32C0200	137€



# CHIMENEA INDIVIDUAL

## Sistema DW - ECO 1.0 304

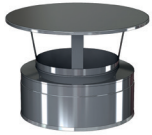

Terminal anti-lluvia

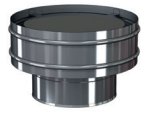

Terminal anti-viento

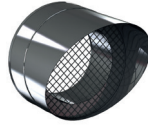

Terminal horizontal con rejilla



Terminal GAS light

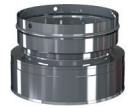

Adaptador a Hurricane

Ø130	909-DWECO5260130	109€	Ø130	909-DWECO5270130	157€	Ø130	909-DWECO5320130	97€	Ø130	908-DWECO43500130	233€	Ø130	908-DWECO44760130	104€
Ø150	909-DWECO5260150	122€	Ø150	909-DWECO5270150	173€	Ø150	909-DWECO5320150	109€	Ø150	908-DWECO43500150	256€	Ø150	908-DWECO44760150	132€
Ø180	909-DWECO5260180	141€	Ø180	909-DWECO5270180	205€	Ø180	909-DWECO5320180	129€	Ø180	908-DWECO43500180	280€	Ø180	908-DWECO44760180	161€
Ø200	909-DWECO5260200	163€	Ø200	909-DWECO5270200	236€	Ø200	909-DWECO5320200	150€	Ø200	908-DWECO43500200	313€	Ø200	908-DWECO44760200	203€

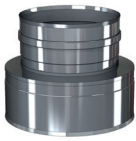

Adaptador doble a simple

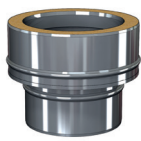

Adaptador simple a doble

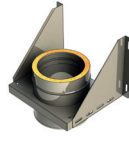

Soporte de carga regulable



Pasamuros EI

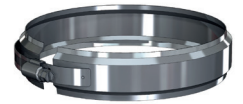

Abrazadera de unión 1.0

Ø130	908-DWECO37A0130	47.13€	Ø130	908-DWECO370130	47.13€	Ø130	908-DWECO3790130	178€	Ø130	909-DWECO43300130	526€	Ø130	665-ZUWA450180	9.75€
Ø150	908-DWECO37A0150	52€	Ø150	908-DWECO370150	52€	Ø150	908-DWECO3790150	202€	Ø150	909-DWECO43300150	510€	Ø150	665-ZUWA450200	11.38€
Ø180	908-DWECO37A0180	65€	Ø180	908-DWECO370180	65€	Ø180	908-DWECO3790180	234€	Ø180	909-DWECO43300180	608€	Ø180	665-ZUWA450230	14.65€
Ø200	908-DWECO37A0200	74€	Ø200	908-DWECO370200	74€	Ø200	908-DWECO3790200	268€	Ø200	909-DWECO43300200	676€	Ø200	665-ZUWA450250	21.16€



Abrazadera fijación pared regulable 50-80mm



Base de abrazadera distanciadora



Alas distanciadoras A



Alas distanciadoras B



Alas distanciadoras C

Ø130	665-ZUWA5560180	39.04€	Ø130	665-ZUWA14620180	52€	Ø130	665-ZUWA1462A	47.13€	Ø130	665-ZUWA1462B	65€	Ø130	665-ZUWA1462C	81€
Ø150	665-ZUWA5560200	45.58€	Ø150	665-ZUWA14620200	58€	Ø150	665-ZUWA1462A	47.13€	Ø150	665-ZUWA1462B	65€	Ø150	665-ZUWA1462C	81€
Ø180	665-ZUWA5560230	52€	Ø180	665-ZUWA14620230	77€	Ø180	665-ZUWA1462A	47.13€	Ø180	665-ZUWA1462B	65€	Ø180	665-ZUWA1462C	81€
Ø200	665-ZUWA5560250	61€	Ø200	665-ZUWA14620250	100€	Ø200	665-ZUWA1462A	47.13€	Ø200	665-ZUWA1462B	65€	Ø200	665-ZUWA1462C	81€



Alas distanciadoras D

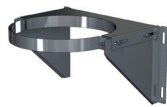

Abrazadera de soporte



Abrazadera con doble pértiga telescópica L=2000mm



Abrazadera fijación a techo



Abrazadera forjado inox

Ø130	665-ZUWA1462D	104€	Ø130	665-ZUWA8580180	145€	Ø130	665-ZUWA1910180	156€	Ø130	665-ZUWA118B0180	48.72€	Ø130	665-ZUWA620180	42.42€
Ø150	665-ZUWA1462D	104€	Ø150	665-ZUWA8580200	145€	Ø150	665-ZUWA1910200	173€	Ø150	665-ZUWA118B0200	59€	Ø150	665-ZUWA620200	47.13€
Ø180	665-ZUWA1462D	104€	Ø180	665-ZUWA8580230	163€	Ø180	665-ZUWA1910230	179€	Ø180	665-ZUWA118B0230	66€	Ø180	665-ZUWA620230	50€
Ø200	665-ZUWA1462D	104€	Ø200	665-ZUWA8580250	185€	Ø200	665-ZUWA1910250	196€	Ø200	665-ZUWA118B0250	66€	Ø200	665-ZUWA620250	50€

**i** Precio unidad. u/c= unidad caja.

**i** Necesario instalar collarín con el cubreaguas.

**i** Consultar página 91 para ver distancias de separación.



Abrazadera para amarre por tornillo



Abrazadera vientos



Soporte de techo



Collarín antitormenta

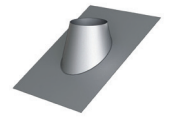

Cubreaguas 25°-45° aluminio

Ø130	665-ZUWA10630180	39.04€	Ø130	665-ZUWA420180	21.16€	Ø130	665-ZUWA9360180	50€	Ø130	665-ZUWA3070180	40.87€	Ø130	665-ZUWA939AL0180	250€
Ø150	665-ZUWA10630200	42.42€	Ø150	665-ZUWA420200	26.04€	Ø150	665-ZUWA9360200	56€	Ø150	665-ZUWA3070200	47.13€	Ø150	665-ZUWA939AL0200	269€
Ø180	665-ZUWA10630230	50€	Ø180	665-ZUWA420230	27.67€	Ø180	665-ZUWA9360230	65€	Ø180	665-ZUWA3070230	52€	Ø180	665-ZUWA939AL0230	288€
Ø200	665-ZUWA10630250	50€	Ø200	665-ZUWA420250	29.27€	Ø200	665-ZUWA9360250	73€	Ø200	665-ZUWA3070250	59€	Ø200	665-ZUWA939AL0250	305€

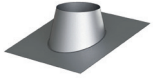

Cubreaguas 5°-25° aluminio

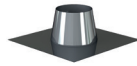

Cubreaguas plano inox



Cubreaguas plomo 0°-5°

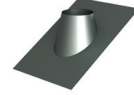

Cubreaguas plomo 25°-45°

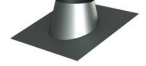

Cubreaguas plomo 5°-25°

Ø130	665-ZUWA938AL0180	235€	Ø130	665-ZUWA11280180	170€	Ø130	665-ZUWA9370180	234€	Ø130	665-ZUWA9390180	379€	Ø130	665-ZUWA9380180	234€
Ø150	665-ZUWA938AL0200	252€	Ø150	665-ZUWA11280200	185€	Ø150	665-ZUWA9370200	260€	Ø150	665-ZUWA9390200	386€	Ø150	665-ZUWA9380200	260€
Ø180	665-ZUWA938AL0230	261€	Ø180	665-ZUWA11280230	191€	Ø180	665-ZUWA9370230	269€	Ø180	665-ZUWA9390230	397€	Ø180	665-ZUWA9380230	269€
Ø200	665-ZUWA938AL0250	282€	Ø200	665-ZUWA11280250	211€	Ø200	665-ZUWA9370250	294€	Ø200	665-ZUWA9390250	401€	Ø200	665-ZUWA9380250	294€



Pasamuros



Junta de silicona (T<200°C)

Ø130	665-ZUWA9870180	52€	Ø130	665-ZUWA260130	4.88€
Ø150	665-ZUWA9870200	52€	Ø150	665-ZUWA260150	4.88€
Ø180	665-ZUWA9870230	64€	Ø180	665-ZUWA260180	6.52€
Ø200	665-ZUWA9870250	65€	Ø200	665-ZUWA260200	8.15€



# CHIMENEA INDIVIDUAL

## Sistema DW - ECO 1.0 304

### ADAPTADOR CALDERA HEMBRA

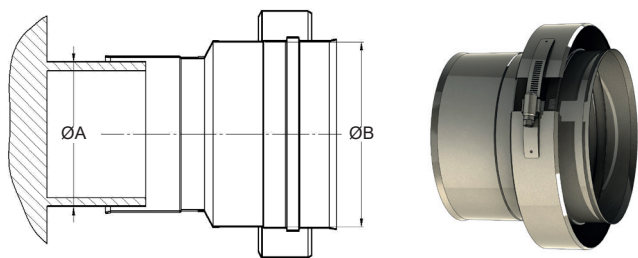

CÓDIGO	Ø A	Ø B	€
908-DWECO37H00800130	Ø80	Ø130	74€
908-DWECO37H01000130	Ø100	Ø130	74€
908-DWECO37H01000150	Ø100	Ø150	83€
908-DWECO37H01100130	Ø110	Ø130	74€
908-DWECO37H01100150	Ø110	Ø150	83€
908-DWECO37H01200130	Ø120	Ø130	74€
908-DWECO37H01200150	Ø120	Ø150	83€
908-DWECO37H01250130	Ø125	Ø130	50€
908-DWECO37H01250150	Ø125	Ø150	83€
908-DWECO37H01300130	Ø130	Ø130	50€
908-DWECO37H01300150	Ø130	Ø150	84€
908-DWECO37H01300180	Ø130	Ø180	100€
908-DWECO37H01350130	Ø135	Ø130	50€
908-DWECO37H01350150	Ø135	Ø150	84€
908-DWECO37H01350180	Ø135	Ø180	100€
908-DWECO37H01400130	Ø140	Ø130	83€
908-DWECO37H01400150	Ø140	Ø150	56€
908-DWECO37H01400180	Ø140	Ø180	101€
908-DWECO37H01500130	Ø150	Ø130	83€
908-DWECO37H01500150	Ø150	Ø150	56€
908-DWECO37H01500180	Ø150	Ø180	101€
908-DWECO37H01500200	Ø150	Ø200	119€
908-DWECO37H01600130	Ø160	Ø130	96€
908-DWECO37H01600150	Ø160	Ø150	56€
908-DWECO37H01600180	Ø160	Ø180	101€
908-DWECO37H01600200	Ø160	Ø200	119€
908-DWECO37H01750130	Ø175	Ø130	96€
908-DWECO37H01750150	Ø175	Ø150	97€
908-DWECO37H01750180	Ø175	Ø180	67€
908-DWECO37H01750200	Ø175	Ø200	119€
908-DWECO37H01800130	Ø180	Ø130	96€
908-DWECO37H01800150	Ø180	Ø150	97€
908-DWECO37H01800180	Ø180	Ø180	67€
908-DWECO37H01800200	Ø180	Ø200	121€
908-DWECO37H02000150	Ø200	Ø150	101€
908-DWECO37H02000180	Ø200	Ø180	111€
908-DWECO37H02000200	Ø200	Ø200	78€
908-DWECO37H02250180	Ø225	Ø180	117€
908-DWECO37H02250200	Ø225	Ø200	123€
908-DWECO37H02500180	Ø250	Ø180	117€
908-DWECO37H02500200	Ø250	Ø200	123€

### AMPLIACIONES

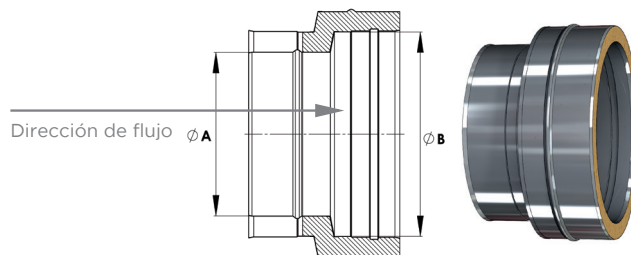

CÓDIGO	Ø A	Ø B	€
908-DWECO A00800130	Ø80	Ø130	122€
908-DWECO A00800150	Ø80	Ø150	161€
908-DWECO A00800180	Ø80	Ø180	206€
908-DWECO A00800200	Ø80	Ø200	269€
908-DWECO A01000130	Ø100	Ø130	110€
908-DWECO A01000150	Ø100	Ø150	156€
908-DWECO A01000180	Ø100	Ø180	200€
908-DWECO A01000200	Ø100	Ø200	256€
908-DWECO A01300150	Ø130	Ø150	140€
908-DWECO A01300180	Ø130	Ø180	188€
908-DWECO A01300200	Ø130	Ø200	247€
908-DWECO A01500180	Ø150	Ø180	172€
908-DWECO A01500200	Ø150	Ø200	239€
908-DWECO A01800200	Ø180	Ø200	215€

### REDUCCIONES

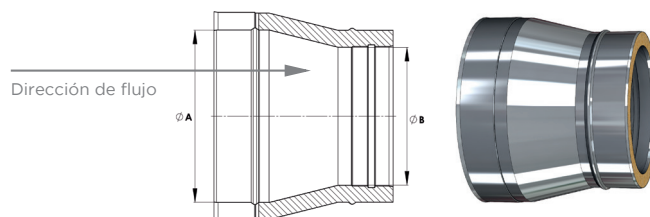

CÓDIGO	Ø A	Ø B	€
908-DWECOR01500130	Ø150	Ø130	140€
908-DWECOR01800130	Ø180	Ø130	188€
908-DWECOR01800150	Ø180	Ø150	172€
908-DWECOR02000130	Ø200	Ø130	247€
908-DWECOR02000150	Ø200	Ø150	239€
908-DWECOR02000180	Ø200	Ø180	215€

# CÓMO CORTAR UN MÓDULO RECTO DE DW-ECO O DW-FT EI30

El sistema DW-FT de JEREMIAS es el **único del mercado** capaz de ser **cortado a medida** para **cualquier longitud** deseada

## INSTRUCCIONES DE CORTE

**1** Cortar el tubo exterior a la medida requerida desechando el macho exterior

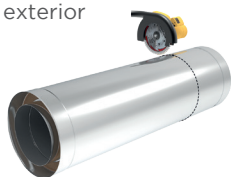

**2** Podrás ver el aislante rígido



**3** Cortar el aislante alrededor del tubo interior

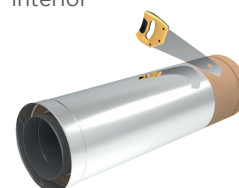

**4** Podrás ver la parte hembra del tubo interior

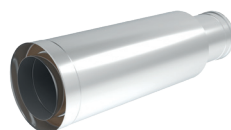

**5** Empujar el tubo y cortar el sobrante (macho)

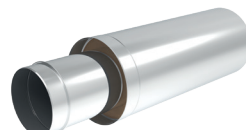

**6** Tubo cortado a medida con caja interior para junta

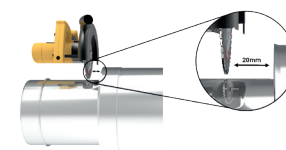

**i** Para el sistema 2.0 la abrazadera de unión se tendrá que colocar en el sentido contrario, de tal modo que la protuberancia más alta entre en la caja que queda en el tubo, y la protuberancia más baja abrace el tubo sin caja.



## Chimeneas Simple Pared y Concéntricas para Calderas

Los sistemas de simple pared y los sistemas concéntricos de JEREMIAS son ideales para entubados en renovaciones de salas de calderas por su facilidad de instalación desde la cubierta, mediante el uso de las abrazaderas de descenso, haciendo las uniones en cubierta y descolgando la chimenea desde arriba.

Se recomienda que los patinillos por los que discurran las chimeneas de simple pared (especialmente en instalaciones de grupos electrógenos y calderas de no condensación) estén ventilados para evitar que la temperatura de las paredes de dichos patinillos aumente en exceso.

Hay que tener en cuenta que en el caso de edificios con estructura de madera ésta recomendación pasa a ser una obligación para evitar un eventual incendio, además de tener que respetar las distancias a material combustible indicadas en la certificación del producto.



### APLICACIONES

- Calderas de gas
- Calderas de gasoil
- Calderas de combustibles sólidos
- Condensación
- Entubados
- Estufas y fuegos bajos
- Generadores de aire caliente
- Hornos de panadería
- Ventilación
- Extracción de químicos (no clorados)

	Gas natural	Gasoil	Comb. Sólidos	Condensación	Condiciones húmedas	Temperatura (°C)	Material interior	Espesor mat. Interior (mm)	N=tiro natural P= sobrepresión H=altas presiones	Resist. fuego de hollín
EW-ECO 304	●	●	-	-	-	600	AISI 304	0.4 - 0.5 - 0.6 según Ø	N	●
	●	●	-	-	●	400	AISI 304	0.4 - 0.5 - 0.6 según Ø	N	-
	●	●	-	-	●	200	AISI 304	0.4 - 0.5 - 0.6 según Ø	P	-
EW-ECO 316	●	●	●	-	-	600	AISI 316L	0.4 - 0.5 - 0.6 según Ø	N	●
	●	●	-	-	●	400	AISI 316L	0.4 - 0.5 - 0.6 según Ø	N	-
	●	●	-	-	●	200	AISI 316L	0.4 - 0.5 - 0.6 según Ø	P	-
EW-ECO CONDENSING	●	●	-	●	●	120	AISI 316L	0.4 - 0.5 - 0.6 según Ø	P	-
TWIN-ECO 316	●	●	-	●	●	120	AISI 316L	0.4	P	-
	●	●	-	-	●	200	AISI 316L	0.4	N	-



Con junta de condensación.



### PESOS (kg)

	EW-ECO 304	EW-ECO 316	EW-ECO CONDENSING	TWIN ECO
Ø 80	0,9	0,9	0,9	2,3
Ø 100	1,1	1,1	1,1	2,7
Ø 130	1,4	1,4	1,4	3,5
Ø 150	1,6	1,6	1,6	-
Ø 180	1,9	1,9	1,9	-
Ø 200	2,1	2,1	2,1	-
Ø 250	2,7	2,7	2,7	-
Ø 300	3,2	3,2	3,2	-
Ø 350	4,7	4,7	4,7	-
Ø 400	5,3	5,3	5,3	-
Ø 450	6,0	6,0	6,0	-
Ø 500	6,7	6,7	6,7	-
Ø 550	7,3	7,3	7,3	-
Ø 600	9,6	9,6	9,6	-
Ø 650	10,4	10,4	10,4	-
Ø 700	11,22	11,22	11,22	-
Ø 750	12,0	12,0	12,0	-
Ø 800	12,8	12,8	12,8	-



### ALTURAS (m)

	EW-ECO 304	EW-ECO 316	EW-ECO CONDENSING	TWIN ECO
Ø 80	50	50	50	-
Ø 100	50	50	50	-
Ø 130	50	50	50	-
Ø 150	50	50	50	-
Ø 180	50	50	50	-
Ø 200	50	50	50	-
Ø 250	50	50	50	-
Ø 300	50	50	50	-
Ø 350	43	43	43	-
Ø 400	38	38	38	-
Ø 450	33	33	33	-
Ø 500	30	30	30	-
Ø 550	27	27	27	-
Ø 600	21	21	21	-
Ø 650	19	19	19	-
Ø 700	18	18	18	-
Ø 750	17	17	17	-
Ø 800	16	16	16	-

### Pesos alturas entre soportes

A continuación se indican a modo de referencia los pesos aproximados por metro lineal de chimenea en cada modelo y diámetro, así como las alturas máximas entre soportes de carga en función del diámetro para instalación vertical. En la base de la vertical es necesaria la colocación de un soporte de carga (recomendablemente por encima de la te de conexión).

Asimismo, en instalación horizontal se recomienda que la distancia entre abrazaderas de fijación sea de 2m. En instalación vertical la distancia entre abrazaderas de fijación pared debe ser de 4m como máximo.

**EW-ECO CONDENSING:** para la evacuación de gases de combustión en calderas de condensación (con junta de condensación).

**EW-ECO 316:** para las instalaciones de combustibles sólidos.

**EW-ECO 304:** para cualquier tipo de caldera de gas natural de no condensación.

**TWIN-ECO 316:** Para la evacuación de gases y admisión de aire concéntricas en todo tipo de calderas de gas y gasoil (incluidas las calderas de condensación).

1. Terminal antilluvia (**EWEC 526**)
2. Cubreaguas (**EWEC 13**)
3. Módulo recto 1.000 mm (**EWEC 1128**)
4. Soporte de carga regulable (**EWEC 379**)
5. Te 87° (**EWEC 11**)
6. Colector de hollín con desagüe (**EWEC 44**)
7. Codo 87° (**EWEC 64**)
8. Módulo recto 500 mm (**EWEC 14**)
9. Adaptador caldera (**EWEC 37m**)

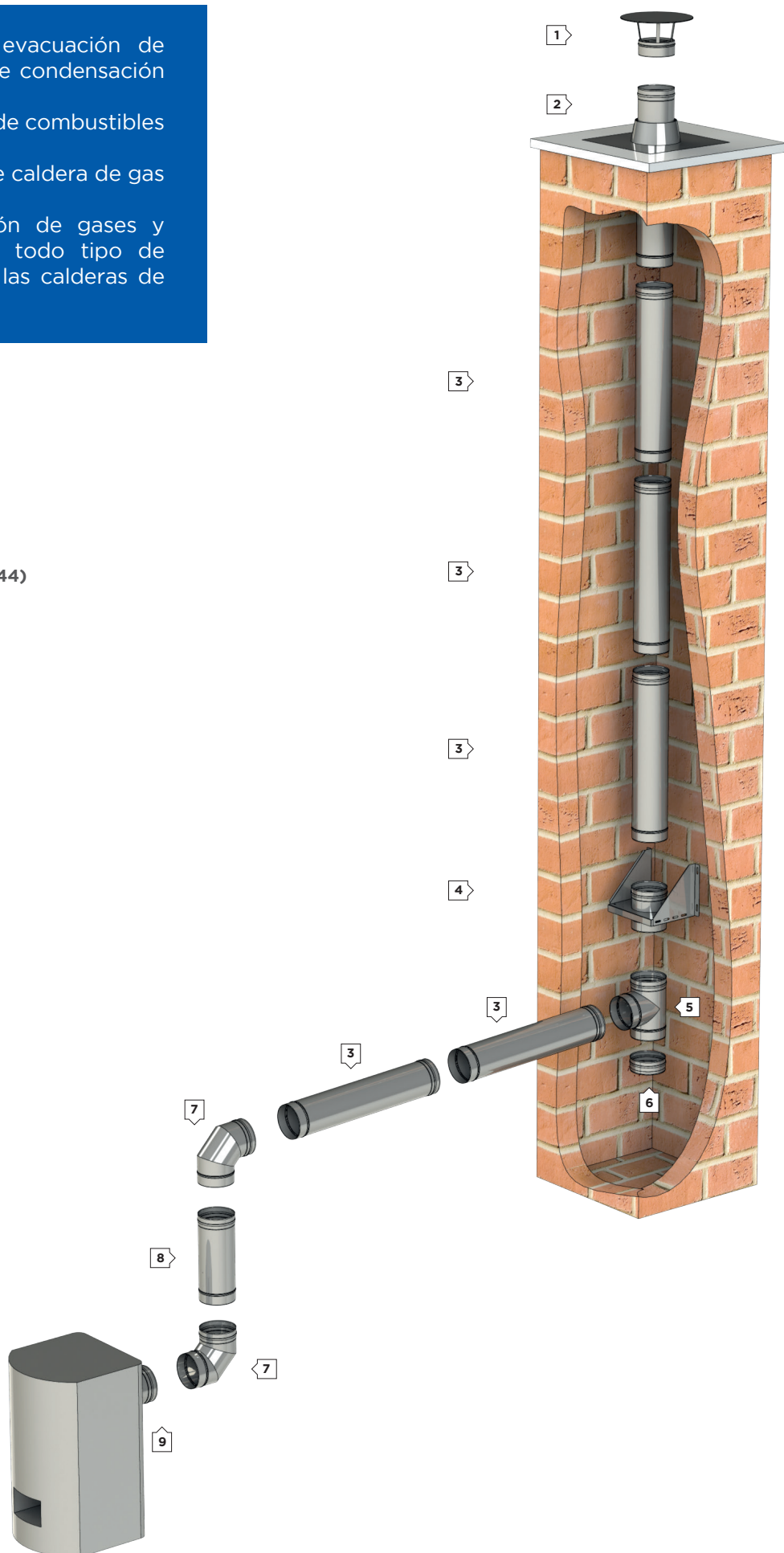



# CHIMENEA INDIVIDUAL

## Sistema EW - ECO CONDENSING

Chimenea modular metálica para evacuación de humos y gases de los productos de la combustión de simple pared fabricada en acero inoxidable

### MATERIAL

AISI 316L

### ACABADO EXTERIOR

Brillante

Colores RAL (consulta página 14 para acabados especiales)

### ESPEORES (mm)

0,4 - 0,5 - 0,6 - 0,8 (según el diámetro)

### DIÁMETROS DISPONIBLES (mm)

Ø80 a Ø600

### SISTEMA DE UNIÓN

Conexión macho-hembra con **abrazadera de unión sencilla**



### APLICACIONES

- Calderas de condensación
- Instalaciones de condensación



### CARACTERÍSTICAS

- Instalación en salas de calderas y patinillos interiores.
- Temperatura de trabajo hasta 120°C
- **Soldadura TIG/LÁSER** en continuo en todas las piezas
- Abrazadera de unión **NO INCLUIDA**
- Posibilidad de **corte de módulos rectos a medida en obra**
- **Junta de condensación INCLUIDA (excepto terminales)**

### CERTIFICADO CE

0036 CPR 9174 029

### CLASIFICACIONES CE (UNE-EN 1856-1)

T120 - P1 - W - V2 - L50040 - O(00)



Módulo recto 1000mm



Módulo recto 500mm



Módulo recto 250mm



Módulo recto 250mm con  
desagüe lateral



Módulo recto regulable  
400-560mm

Ø80	L02-EWEC130080	49.41€	Ø80	L02-EWEC140080	36.11€	Ø80	L02-EWEC150080	27.86€	Ø80	L02-EWEC15D0080	34.44€	Ø80	L02-EWEC5440080	79€
Ø100	L02-EWEC130100	58€	Ø100	L02-EWEC140100	37.75€	Ø100	L02-EWEC150100	29.51€	Ø100	L02-EWEC15D0100	34.44€	Ø100	L02-EWEC5440100	88€
Ø130	L02-EWEC130130	76€	Ø130	L02-EWEC140130	44.36€	Ø130	L02-EWEC150130	32.83€	Ø130	L02-EWEC15D0130	34.44€	Ø130	L02-EWEC5440130	96€
Ø150	L02-EWEC130150	84€	Ø150	L02-EWEC140150	47.79€	Ø150	L02-EWEC150150	34.44€	Ø150	L02-EWEC15D0150	37.75€	Ø150	L02-EWEC5440150	116€
Ø180	L02-EWEC130180	98€	Ø180	L02-EWEC140180	55€	Ø180	L02-EWEC150180	37.71€	Ø180	L02-EWEC15D0180	44.32€	Ø180	L02-EWEC5440180	140€
Ø200	L02-EWEC130200	109€	Ø200	L02-EWEC140200	64€	Ø200	L02-EWEC150200	40.92€	Ø200	L02-EWEC15D0200	49.4€	Ø200	L02-EWEC5440200	163€
Ø250	L02-EWEC130250	144€	Ø250	L02-EWEC140250	82€	Ø250	L02-EWEC150250	49.05€	Ø250	L02-EWEC15D0250	60€	Ø250	L02-EWEC5440250	200€
Ø300	L02-EWEC130300	174€	Ø300	L02-EWEC140300	100€	Ø300	L02-EWEC150300	60€	Ø300	L02-EWEC15D0300	72€	Ø300	L02-EWEC5440300	239€
Ø350	L02-EWEC130350	232€	Ø350	L02-EWEC140350	127€	Ø350	L02-EWEC150350	68€	Ø350	L02-EWEC15D0350	92€	Ø350	L02-EWEC5440350	266€
Ø400	L02-EWEC130400	261€	Ø400	L02-EWEC140400	139€	Ø400	L02-EWEC150400	73€	Ø400	L02-EWEC15D0400	107€	Ø400	L02-EWEC5440400	290€
Ø450	L02-EWEC130450	315€	Ø450	L02-EWEC140450	183€	Ø450	L02-EWEC150450	107€	Ø450	L02-EWEC15D0450	148€	Ø450	L02-EWEC5440450	352€
Ø500	L02-EWEC130500	373€	Ø500	L02-EWEC140500	239€	Ø500	L02-EWEC150500	151€	Ø500	L02-EWEC15D0500	199€	Ø500	L02-EWEC5440500	386€
Ø550	L02-EWEC130550	430€	Ø550	L02-EWEC140550	278€	Ø550	L02-EWEC150550	180€	Ø550	L02-EWEC15D0550	232€	Ø550	L02-EWEC5440550	420€
Ø600	L02-EWEC130600	465€	Ø600	L02-EWEC140600	290€	Ø600	L02-EWEC150600	184€	Ø600	L02-EWEC15D0600	235€	Ø600	L02-EWEC5440600	453€



Módulo recto regulable  
560-920mm



Módulo de descenso



Codo 15° condensación

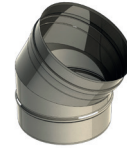

Codo 30° condensación



Codo 45° condensación

Ø80	L02-EWEC5450080	94€	Ø80	L02-EWEC14680080	76€	Ø80	L02-EWEC16W0080	27.86€	Ø80	L02-EWEC17W0080	27.86€	Ø80	L02-EWEC18W0080	27.86€
Ø100	L02-EWEC5450100	103€	Ø100	L02-EWEC14680100	92€	Ø100	L02-EWEC16W0100	29.51€	Ø100	L02-EWEC17W0100	29.51€	Ø100	L02-EWEC18W0100	29.51€
Ø130	L02-EWEC5450130	113€	Ø130	L02-EWEC14680130	117€	Ø130	L02-EWEC16W0130	37.75€	Ø130	L02-EWEC17W0130	37.75€	Ø130	L02-EWEC18W0130	37.75€
Ø150	L02-EWEC5450150	139€	Ø150	L02-EWEC14680150	130€	Ø150	L02-EWEC16W0150	46.23€	Ø150	L02-EWEC17W0150	46.23€	Ø150	L02-EWEC18W0150	46.23€
Ø180	L02-EWEC5450180	166€	Ø180	L02-EWEC14680180	155€	Ø180	L02-EWEC16W0180	58€	Ø180	L02-EWEC17W0180	58€	Ø180	L02-EWEC18W0180	58€
Ø200	L02-EWEC5450200	194€	Ø200	L02-EWEC14680200	176€	Ø200	L02-EWEC16W0200	66€	Ø200	L02-EWEC17W0200	66€	Ø200	L02-EWEC18W0200	66€
Ø250	L02-EWEC5450250	237€	Ø250	L02-EWEC14680250	229€	Ø250	L02-EWEC16W0250	77€	Ø250	L02-EWEC17W0250	77€	Ø250	L02-EWEC18W0250	77€
Ø300	L02-EWEC5450300	286€	Ø300	L02-EWEC14680300	275€	Ø300	L02-EWEC16W0300	113€	Ø300	L02-EWEC17W0300	113€	Ø300	L02-EWEC18W0300	113€
Ø350	L02-EWEC5450350	316€	Ø350	L02-EWEC14680350	366€	Ø350	L02-EWEC16W0350	156€	Ø350	L02-EWEC17W0350	156€	Ø350	L02-EWEC18W0350	156€
Ø400	L02-EWEC5450400	347€	Ø400	L02-EWEC14680400	414€	Ø400	L02-EWEC16W0400	181€	Ø400	L02-EWEC17W0400	181€	Ø400	L02-EWEC18W0400	181€
Ø450	L02-EWEC5450450	384€	Ø450	L02-EWEC14680450	500€	Ø450	L02-EWEC16W0450	266€	Ø450	L02-EWEC17W0450	266€	Ø450	L02-EWEC18W0450	266€
Ø500	L02-EWEC5450500	430€	Ø500	L02-EWEC14680500	597€	Ø500	L02-EWEC16W0500	302€	Ø500	L02-EWEC17W0500	302€	Ø500	L02-EWEC18W0500	302€
Ø550	L02-EWEC5450550	481€	Ø550	L02-EWEC14680550	684€	Ø550	L02-EWEC16W0550	353€	Ø550	L02-EWEC17W0550	353€	Ø550	L02-EWEC18W0550	353€
Ø600	L02-EWEC5450600	525€	Ø600	L02-EWEC14680600	742€	Ø600	L02-EWEC16W0600	383€	Ø600	L02-EWEC17W0600	383€	Ø600	L02-EWEC18W0600	383€



# CHIMENEA INDIVIDUAL

## Sistema EW - ECO CONDENSING



Codo 60° condensación



Codo 87°



Codo 90° condensación



Codo 0°-90°  
Multidireccional



Te 87°

Ø80	L02-EWEC84W0080	41.06€	Ø80	L02-EWEC640080	44.36€	Ø80	L02-EWEC60W0080	44.5€	Ø80	L02-EWEC101D0080	74€	Ø80	L02-EWEC110080	80€
Ø100	L02-EWEC84W0100	42.73€	Ø100	L02-EWEC640100	47.79€	Ø100	L02-EWEC60W0100	47.96€	Ø100	L02-EWEC101D0100	74€	Ø100	L02-EWEC110100	91€
Ø130	L02-EWEC84W0130	46.23€	Ø130	L02-EWEC640130	53€	Ø130	L02-EWEC60W0130	53€	Ø130	L02-EWEC101D0130	88€	Ø130	L02-EWEC110130	104€
Ø150	L02-EWEC84W0150	57€	Ø150	L02-EWEC640150	63€	Ø150	L02-EWEC60W0150	63€	Ø150	L02-EWEC101D0150	104€	Ø150	L02-EWEC110150	127€
Ø180	L02-EWEC84W0180	68€	Ø180	L02-EWEC640180	80€	Ø180	L02-EWEC60W0180	80€	Ø180	L02-EWEC101D0180	123€	Ø180	L02-EWEC110180	131€
Ø200	L02-EWEC84W0200	81€	Ø200	L02-EWEC640200	94€	Ø200	L02-EWEC60W0200	96€	Ø200	L02-EWEC101D0200	144€	Ø200	L02-EWEC110200	166€
Ø250	L02-EWEC84W0250	100€	Ø250	L02-EWEC640250	118€	Ø250	L02-EWEC60W0250	117€				Ø250	L02-EWEC110250	198€
Ø300	L02-EWEC84W0300	136€	Ø300	L02-EWEC640300	153€	Ø300	L02-EWEC60W0300	155€				Ø300	L02-EWEC110300	229€
Ø350	L02-EWEC84W0350	177€	Ø350	L02-EWEC640350	205€	Ø350	L02-EWEC60W0350	205€				Ø350	L02-EWEC110350	277€
Ø400	L02-EWEC84W0400	205€	Ø400	L02-EWEC640400	234€	Ø400	L02-EWEC60W0400	234€				Ø400	L02-EWEC110400	318€
Ø450	L02-EWEC84W0450	294€	Ø450	L02-EWEC640450	339€	Ø450	L02-EWEC60W0450	337€				Ø450	L02-EWEC110450	486€
Ø500	L02-EWEC84W0500	332€	Ø500	L02-EWEC640500	385€	Ø500	L02-EWEC60W0500	386€				Ø500	L02-EWEC110500	594€
Ø550	L02-EWEC84W0550	367€	Ø550	L02-EWEC640550	423€	Ø550	L02-EWEC60W0550	424€				Ø550	L02-EWEC110550	743€
Ø600	L02-EWEC84W0600	401€	Ø600	L02-EWEC640600	451€	Ø600	L02-EWEC60W0600	453€				Ø600	L02-EWEC110600	845€



Te 90° condensación



Te 135°



Colector de hollín

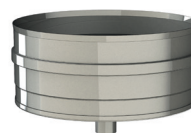

Colector de hollín con  
desagüe W

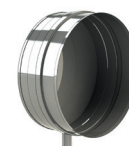

Colector de hollín con  
desagüe lateral

Ø80	L02-EWEC317W0080	80€	Ø80	L02-EWEC120080	88€	Ø80	L02-EWEC551W0080	41.06€	Ø80	L02-EWEC44W0080	51€	Ø80	L02-EWEC10080	57€
Ø100	L02-EWEC317W0100	91€	Ø100	L02-EWEC120100	96€	Ø100	L02-EWEC551W0100	42.73€	Ø100	L02-EWEC44W0100	53€	Ø100	L02-EWEC10100	58€
Ø130	L02-EWEC317W0130	104€	Ø130	L02-EWEC120130	102€	Ø130	L02-EWEC551W0130	47.79€	Ø130	L02-EWEC44W0130	59€	Ø130	L02-EWEC10130	61€
Ø150	L02-EWEC317W0150	127€	Ø150	L02-EWEC120150	127€	Ø150	L02-EWEC551W0150	51€	Ø150	L02-EWEC44W0150	61€	Ø150	L02-EWEC10150	66€
Ø180	L02-EWEC317W0180	131€	Ø180	L02-EWEC120180	148€	Ø180	L02-EWEC551W0180	61€	Ø180	L02-EWEC44W0180	61€	Ø180	L02-EWEC10180	68€
Ø200	L02-EWEC317W0200	166€	Ø200	L02-EWEC120200	171€	Ø200	L02-EWEC551W0200	66€	Ø200	L02-EWEC44W0200	69€	Ø200	L02-EWEC10200	74€
Ø250	L02-EWEC317W0250	198€	Ø250	L02-EWEC120250	213€	Ø250	L02-EWEC551W0250	77€	Ø250	L02-EWEC44W0250	94€	Ø250	L02-EWEC10250	100€
Ø300	L02-EWEC317W0300	229€	Ø300	L02-EWEC120300	270€	Ø300	L02-EWEC551W0300	100€	Ø300	L02-EWEC44W0300	113€	Ø300	L02-EWEC10300	126€
Ø350	L02-EWEC317W0350	277€	Ø350	L02-EWEC120350	296€	Ø350	L02-EWEC551W0350	118€	Ø350	L02-EWEC44W0350	140€	Ø350	L02-EWEC10350	156€
Ø400	L02-EWEC317W0400	318€	Ø400	L02-EWEC120400	327€	Ø400	L02-EWEC551W0400	153€	Ø400	L02-EWEC44W0400	233€	Ø400	L02-EWEC10400	254€
Ø450	L02-EWEC317W0450	486€	Ø450	L02-EWEC120450	499€	Ø450	L02-EWEC551W0450	207€	Ø450	L02-EWEC44W0450	290€	Ø450	L02-EWEC10450	320€
Ø500	L02-EWEC317W0500	594€	Ø500	L02-EWEC120500	581€	Ø500	L02-EWEC551W0500	221€	Ø500	L02-EWEC44W0500	331€	Ø500	L02-EWEC10500	363€
Ø550	L02-EWEC317W0550	743€	Ø550	L02-EWEC120550	722€	Ø550	L02-EWEC551W0550	296€	Ø550	L02-EWEC44W0550	359€	Ø550	L02-EWEC10550	392€
Ø600	L02-EWEC317W0600	845€	Ø600	L02-EWEC120600	1640€	Ø600	L02-EWEC551W0600	308€	Ø600	L02-EWEC44W0600	370€	Ø600	L02-EWEC10600	405€



En los diámetros Ø80 y Ø100 las lamas sobresalen del diámetro del tubo.



Para ángulos diferentes de 90° se produce un cierto desplazamiento del eje.



Codo 90° con tapa de inspección P1



Módulo de inspección



Módulo de inspección con tapa 200 Pa (P1)



Terminal salida libre



Terminal anti-lluvia

Ø80	L02-EWEC19AL0080	105€	Ø80	L02-EWEC5430080	46.23€	Ø80	L02-EWEC5490080	148€	Ø80	671-EWEC320080	58€	Ø80	671-EWEC5260080	80€
Ø100	L02-EWEC19AL0100	127€	Ø100	L02-EWEC5430100	51€	Ø100	L02-EWEC5490100	163€	Ø100	671-EWEC320100	65€	Ø100	671-EWEC5260100	90€
Ø130	L02-EWEC19AL0130	135€	Ø130	L02-EWEC5430130	55€	Ø130	L02-EWEC5490130	173€	Ø130	671-EWEC320130	73€	Ø130	671-EWEC5260130	99€
Ø150	L02-EWEC19AL0150	170€	Ø150	L02-EWEC5430150	67€	Ø150	L02-EWEC5490150	177€	Ø150	671-EWEC320150	90€	Ø150	671-EWEC5260150	123€
Ø180	L02-EWEC19AL0180	209€	Ø180	L02-EWEC5430180	81€	Ø180	L02-EWEC5490180	188€	Ø180	671-EWEC320180	107€	Ø180	671-EWEC5260180	150€
Ø200	L02-EWEC19AL0200	256€	Ø200	L02-EWEC5430200	94€	Ø200	L02-EWEC5490200	199€	Ø200	671-EWEC320200	121€	Ø200	671-EWEC5260200	170€
Ø250	L02-EWEC19AL0250	306€	Ø250	L02-EWEC5430250	112€	Ø250	L02-EWEC5490250	237€	Ø250	671-EWEC320250	150€	Ø250	671-EWEC5260250	210€
Ø300	L02-EWEC19AL0300	342€	Ø300	L02-EWEC5430300	137€	Ø300	L02-EWEC5490300	260€	Ø300	671-EWEC320300	178€	Ø300	671-EWEC5260300	250€
Ø350	L02-EWEC19AL0350	410€	Ø350	L02-EWEC5430350	150€	Ø350	L02-EWEC5490350	302€	Ø350	671-EWEC320350	196€	Ø350	671-EWEC5260350	274€
Ø400	L02-EWEC19AL0400	484€	Ø400	L02-EWEC5430400	165€	Ø400	L02-EWEC5490400	425€	Ø400	671-EWEC320400	215€	Ø400	671-EWEC5260400	303€
Ø450	L02-EWEC19AL0450	733€	Ø450	L02-EWEC5430450	229€	Ø450	L02-EWEC5490450	458€	Ø450	671-EWEC320450	269€			
Ø500	L02-EWEC19AL0500	838€	Ø500	L02-EWEC5430500	272€	Ø500	L02-EWEC5490500	470€	Ø500	671-EWEC320500	289€			
Ø550	L02-EWEC19AL0550	1014€	Ø550	L02-EWEC5430550	287€	Ø550	L02-EWEC5490550	494€	Ø550	671-EWEC320550	368€			
Ø600	L02-EWEC19AL0600	1205€	Ø600	L02-EWEC5430600	306€	Ø600	L02-EWEC5490600	570€	Ø600	671-EWEC320600	398€			



Terminal anti-viento

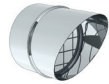

Terminal horizontal con rejilla



Terminal Gas



Terminal GAS light



Adaptador a Hurricane

Ø80	671-EWEC5270080	119€	Ø80	671-EWEC5320080	66€	Ø130	671-EWEC14540130	338€	Ø80	671-EWEC43500080	219€	Ø130	671-EWEC44760130	88€
Ø100	671-EWEC5270100	132€	Ø100	671-EWEC5320100	73€	Ø150	671-EWEC14540150	378€	Ø100	671-EWEC43500100	235€	Ø150	671-EWEC44760150	88€
Ø130	671-EWEC5270130	143€	Ø130	671-EWEC5320130	81€	Ø180	671-EWEC14540180	417€	Ø130	671-EWEC43500130	252€	Ø180	671-EWEC44760180	99€
Ø150	671-EWEC5270150	183€	Ø150	671-EWEC5320150	99€	Ø200	671-EWEC14540200	527€	Ø150	671-EWEC43500150	295€	Ø200	671-EWEC44760200	129€
Ø180	671-EWEC5270180	212€	Ø180	671-EWEC5320180	121€	Ø250	671-EWEC14540250	642€	Ø180	671-EWEC43500180	322€	Ø250	671-EWEC44760250	150€
Ø200	671-EWEC5270200	247€	Ø200	671-EWEC5320200	138€	Ø300	671-EWEC14540300	732€	Ø200	671-EWEC43500200	358€	Ø300	671-EWEC44760300	191€
Ø250	671-EWEC5270250	304€	Ø250	671-EWEC5320250	168€	Ø350	671-EWEC14540350	963€	Ø250	671-EWEC43500250	473€			
Ø300	671-EWEC5270300	364€	Ø300	671-EWEC5320300	202€	Ø400	671-EWEC14540400	1072€	Ø300	671-EWEC43500300	616€			
Ø350	671-EWEC5270350	425€	Ø350	671-EWEC5320350	219€	Ø450	671-EWEC14540450	1300€						
Ø400	671-EWEC5270400	533€	Ø400	671-EWEC5320400	242€	Ø500	671-EWEC14540500	1651€						
			Ø450	671-EWEC5320450	303€	Ø550	671-EWEC14540550	1852€						
			Ø500	671-EWEC5320500	327€	Ø600	671-EWEC14540600	2044€						
			Ø550	671-EWEC5320550	417€									
			Ø600	671-EWEC5320600	452€									



# CHIMENEA INDIVIDUAL

## Sistema EW - ECO CONDENSING



Adaptador doble a simple

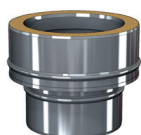

Adaptador simple a doble

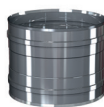

Manguito hembra-hembra



Manguito macho-macho



Soporte de carga regulable

Ø80	B11-DWECO37A0080	58€	Ø80	B11-DWECO370080	56€	Ø80	L02-EWEC6130080	19.61€	Ø80	671-EWEC9720080	14.65€	Ø80	L02-EWEC3790080	72€
Ø100	B11-DWECO37A0100	56€	Ø100	B11-DWECO370100	58€	Ø100	L02-EWEC6130100	27.86€	Ø100	671-EWEC9720100	22.77€	Ø100	L02-EWEC3790100	82€
Ø130	B11-DWECO37A0130	66€	Ø130	B11-DWECO370130	66€	Ø130	L02-EWEC6130130	32.83€	Ø130	671-EWEC9720130	29.27€	Ø130	L02-EWEC3790130	91€
Ø150	B11-DWECO37A0150	61€	Ø150	B11-DWECO370150	61€	Ø150	L02-EWEC6130150	37.75€	Ø150	671-EWEC9720150	32.52€	Ø150	L02-EWEC3790150	106€
Ø180	B11-DWECO37A0180	61€	Ø180	B11-DWECO370180	67€	Ø180	L02-EWEC6130180	49.39€	Ø180	671-EWEC9720180	42.42€	Ø180	L02-EWEC3790180	132€
Ø200	B11-DWECO37A0200	67€	Ø200	B11-DWECO370200	61€	Ø200	L02-EWEC6130200	53€	Ø200	671-EWEC9720200	44€	Ø200	L02-EWEC3790200	148€
Ø80	D15-DWECO37A0080	76€	Ø80	D15-DWECO370080	70€	Ø250	L02-EWEC6130250	61€	Ø250	671-EWEC9720250	48.72€	Ø250	L02-EWEC3790250	185€
Ø100	D15-DWECO37A0100	70€	Ø100	D15-DWECO370100	76€	Ø300	L02-EWEC6130300	68€	Ø300	671-EWEC9720300	54€	Ø300	L02-EWEC3790300	222€
Ø130	D15-DWECO37A0130	92€	Ø130	D15-DWECO370130	83€	Ø350	L02-EWEC6130350	83€	Ø350	671-EWEC9720350	66€	Ø350	L02-EWEC3790350	244€
Ø150	D15-DWECO37A0150	83€	Ø150	D15-DWECO370150	92€	Ø400	L02-EWEC6130400	109€	Ø400	671-EWEC9720400	90€	Ø400	L02-EWEC3790400	270€
Ø180	D15-DWECO37A0180	105€	Ø180	D15-DWECO370180	96€	Ø450	L02-EWEC6130450	123€	Ø450	671-EWEC9720450	101€	Ø450	L02-EWEC3790450	390€
Ø200	D15-DWECO37A0200	96€	Ø200	D15-DWECO370200	105€	Ø500	L02-EWEC6130500	153€	Ø500	671-EWEC9720500	129€	Ø500	L02-EWEC3790500	542€
Ø250	D15-DWECO37A0250	117€	Ø250	D15-DWECO370250	117€	Ø550	L02-EWEC6130550	236€	Ø550	671-EWEC9720550	206€	Ø550	L02-EWEC3790550	782€
Ø300	D15-DWECO37A0300	152€	Ø300	D15-DWECO370300	152€	Ø600	L02-EWEC6130600	270€	Ø600	671-EWEC9720600	236€	Ø600	L02-EWEC3790600	846€
Ø350	D15-DWECO37A0350	187€	Ø350	D15-DWECO370350	187€									
Ø400	D15-DWECO37A0400	233€	Ø400	D15-DWECO370400	233€									
Ø450	D15-DWECO37A0450	250€	Ø450	D15-DWECO370450	250€									
Ø500	D15-DWECO37A0500	277€	Ø500	D15-DWECO370500	277€									
Ø550	D15-DWECO37A0550	341€	Ø550	D15-DWECO370550	341€									
Ø600	D15-DWECO37A0600	354€	Ø600	D15-DWECO370600	354€									



Abrazadera de unión 1.0



Abrazadera fijación pared regulable 50-80mm

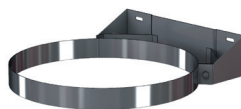

Abrazadera fijación pared fija



Abrazadera fijación pared sencilla



Base de abrazadera distanciadora

Ø80	665-ZUWA450080	6.52€	Ø80	665-ZUWA5560080	30.9€	Ø450	665-ZUWA556F0450	118€	Ø80	665-ZUWA5350080	11.38€	Ø80	665-ZUWA14620080	39.04€
Ø100	665-ZUWA450100	6.52€	Ø100	665-ZUWA5560100	34.15€	Ø500	665-ZUWA556F0500	123€	Ø100	665-ZUWA5350100	14.65€	Ø100	665-ZUWA14620100	40.87€
Ø130	665-ZUWA450130	6.52€	Ø130	665-ZUWA5560130	37.43€	Ø550	665-ZUWA556F0550	155€	Ø130	665-ZUWA5350130	14.65€	Ø130	665-ZUWA14620130	45.58€
Ø150	665-ZUWA450150	8.15€	Ø150	665-ZUWA5560150	39.04€	Ø600	665-ZUWA556F0600	185€	Ø150	665-ZUWA5350150	19.51€	Ø150	665-ZUWA14620150	48.72€
Ø180	665-ZUWA450180	9.75€	Ø180	665-ZUWA5560180	39.04€				Ø180	665-ZUWA5350180	26.04€	Ø180	665-ZUWA14620180	52€
Ø200	665-ZUWA450200	11.38€	Ø200	665-ZUWA5560200	45.58€				Ø200	665-ZUWA5350200	29.27€	Ø200	665-ZUWA14620200	58€
Ø250	665-ZUWA450250	21.16€	Ø250	665-ZUWA5560250	61€							Ø250	665-ZUWA14620250	100€
Ø300	665-ZUWA450300	26.04€	Ø300	665-ZUWA5560300	64€							Ø300	665-ZUWA14620300	138€
Ø350	665-ZUWA450350	29.27€	Ø350	665-ZUWA5560350	67€							Ø350	665-ZUWA14620350	185€
Ø400	665-ZUWA450400	37.43€	Ø400	665-ZUWA5560400	88€							Ø400	665-ZUWA14620400	241€
Ø450	665-ZUWA450450	42.42€	Ø450	665-ZUWA5560450	98€							Ø450	665-ZUWA14620450	298€
Ø500	665-ZUWA450500	47.13€										Ø500	665-ZUWA14620500	328€
Ø550	665-ZUWA450550	50€										Ø550	665-ZUWA14620550	365€
Ø600	665-ZUWA450600	59€										Ø600	665-ZUWA14620600	412€



Consultar página 91 para ver distancias de separación.



Alas distanciadoras A



Alas distanciadoras B



Alas distanciadoras C



Alas distanciadoras D



Abrazadera de descenso

Ø80	665-ZUWA1462A	47.13€	Ø80	665-ZUWA1462B	65€	Ø80	665-ZUWA1462C	81€	Ø80	665-ZUWA1462D	104€	Ø80	665-ZUWA40D0080	14.65€
Ø100	665-ZUWA1462A	47.13€	Ø100	665-ZUWA1462B	65€	Ø100	665-ZUWA1462C	81€	Ø100	665-ZUWA1462D	104€	Ø100	665-ZUWA40D0100	14.65€
Ø130	665-ZUWA1462A	47.13€	Ø130	665-ZUWA1462B	65€	Ø130	665-ZUWA1462C	81€	Ø130	665-ZUWA1462D	104€	Ø130	665-ZUWA40D0130	14.65€
Ø150	665-ZUWA1462A	47.13€	Ø150	665-ZUWA1462B	65€	Ø150	665-ZUWA1462C	81€	Ø150	665-ZUWA1462D	104€	Ø150	665-ZUWA40D0150	19.51€
Ø180	665-ZUWA1462A	47.13€	Ø180	665-ZUWA1462B	65€	Ø180	665-ZUWA1462C	81€	Ø180	665-ZUWA1462D	104€	Ø180	665-ZUWA40D0180	24.4€
Ø200	665-ZUWA1462A	47.13€	Ø200	665-ZUWA1462B	65€	Ø200	665-ZUWA1462C	81€	Ø200	665-ZUWA1462D	104€	Ø200	665-ZUWA40D0200	27.67€
Ø250	665-ZUWA1462A	47.13€	Ø250	665-ZUWA1462B	65€	Ø250	665-ZUWA1462C	81€	Ø250	665-ZUWA1462D	104€	Ø250	665-ZUWA40D0250	40.87€
Ø300	665-ZUWA1462A	47.13€	Ø300	665-ZUWA1462B	65€	Ø300	665-ZUWA1462C	81€	Ø300	665-ZUWA1462D	104€	Ø300	665-ZUWA40D0300	48.72€
Ø350	665-ZUWA1462A	47.13€	Ø350	665-ZUWA1462B	65€	Ø350	665-ZUWA1462C	81€	Ø350	665-ZUWA1462D	104€	Ø350	665-ZUWA40D0350	56€
Ø400	665-ZUWA1462A	47.13€	Ø400	665-ZUWA1462B	65€	Ø400	665-ZUWA1462C	81€	Ø400	665-ZUWA1462D	104€	Ø400	665-ZUWA40D0400	74€
Ø450	665-ZUWA1462A	47.13€	Ø450	665-ZUWA1462B	65€	Ø450	665-ZUWA1462C	81€	Ø450	665-ZUWA1462D	104€	Ø450	665-ZUWA40D0450	84€
Ø500	665-ZUWA1462A	47.13€	Ø500	665-ZUWA1462B	65€	Ø500	665-ZUWA1462C	81€	Ø500	665-ZUWA1462D	104€	Ø500	665-ZUWA40D0500	95€
Ø550	665-ZUWA1462A	47.13€	Ø550	665-ZUWA1462B	65€	Ø550	665-ZUWA1462C	81€	Ø550	665-ZUWA1462D	104€	Ø550	665-ZUWA40D0550	99€
Ø600	665-ZUWA1462A	47.13€	Ø600	665-ZUWA1462B	65€	Ø600	665-ZUWA1462C	81€	Ø600	665-ZUWA1462D	104€	Ø600	665-ZUWA40D0600	117€



Abrazadera de araña

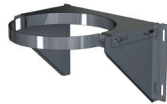

Abrazadera de soporte



Abrazadera con doble pèrtiga telescópica L=2000mm

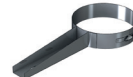

Abrazadera forjado inox



Abrazadera para amarre por tornillo

Ø80	665-ZUWA400080	9.75€	Ø180	665-ZUWA8580180	145€	Ø130	665-ZUWA1910130	144€	Ø80	665-ZUWA620080	17.9€	Ø80	665-ZUWA10630080	26.04€
Ø100	665-ZUWA400100	9.75€	Ø200	665-ZUWA8580200	145€	Ø150	665-ZUWA1910150	146€	Ø100	665-ZUWA620100	21.16€	Ø100	665-ZUWA10630100	29.27€
Ø130	665-ZUWA400130	9.75€	Ø250	665-ZUWA8580250	185€	Ø180	665-ZUWA1910180	156€	Ø130	665-ZUWA620130	26.04€	Ø130	665-ZUWA10630130	32.52€
Ø150	665-ZUWA400150	9.75€	Ø300	665-ZUWA8580300	203€	Ø200	665-ZUWA1910200	173€	Ø150	665-ZUWA620150	30.9€	Ø150	665-ZUWA10630150	35.77€
Ø180	665-ZUWA400180	14.65€	Ø350	665-ZUWA8580350	221€	Ø250	665-ZUWA1910250	196€	Ø180	665-ZUWA620180	42.42€	Ø180	665-ZUWA10630180	39.04€
Ø200	665-ZUWA400200	14.65€	Ø400	665-ZUWA8580400	270€	Ø300	665-ZUWA1910300	233€	Ø200	665-ZUWA620200	47.13€	Ø200	665-ZUWA10630200	42.42€
Ø250	665-ZUWA400250	26.04€	Ø450	665-ZUWA8580450	321€	Ø350	665-ZUWA1910350	249€	Ø250	665-ZUWA620250	50€	Ø250	665-ZUWA10630250	50€
Ø300	665-ZUWA400300	29.27€	Ø500	665-ZUWA8580500	354€	Ø400	665-ZUWA1910400	272€	Ø300	665-ZUWA620300	59€	Ø300	665-ZUWA10630300	65€
Ø350	665-ZUWA400350	34.15€	Ø550	665-ZUWA8580550	401€	Ø450	665-ZUWA1910450	380€	Ø350	665-ZUWA620350	66€	Ø350	665-ZUWA10630350	74€
Ø400	665-ZUWA400400	37.43€	Ø600	665-ZUWA8580600	454€	Ø500	665-ZUWA1910500	496€	Ø400	665-ZUWA620400	74€	Ø400	665-ZUWA10630400	84€
Ø450	665-ZUWA400450	40.87€				Ø550	665-ZUWA1910550	647€	Ø450	665-ZUWA620450	83€	Ø450	665-ZUWA10630450	97€
Ø500	665-ZUWA400500	56€				Ø600	665-ZUWA1910600	699€	Ø500	665-ZUWA620500	96€	Ø500	665-ZUWA10630500	106€
Ø550	665-ZUWA400550	74€							Ø550	665-ZUWA620550	103€	Ø550	665-ZUWA10630550	114€
Ø600	665-ZUWA400600	98€							Ø600	665-ZUWA620600	109€	Ø600	665-ZUWA10630600	129€



# CHIMENEA INDIVIDUAL

## Sistema EW - ECO CONDENSING



Abrazadera vientos



Soporte de techo



Collarín antitormenta

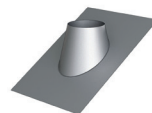

Cubreaguas 25°-45° aluminio

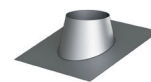

Cubreaguas 5°-25° aluminio

Ø80	665-ZUWA420080	9.75€	Ø80	665-ZUWA9360080	29.27€	Ø80	665-ZUWA3070080	26.04€	Ø80	665-ZUWA939AL0080	187€	Ø80	665-ZUWA938AL0080	184€
Ø100	665-ZUWA420100	9.75€	Ø100	665-ZUWA9360100	32.52€	Ø100	665-ZUWA3070100	27.67€	Ø100	665-ZUWA939AL0100	202€	Ø100	665-ZUWA938AL0100	191€
Ø130	665-ZUWA420130	11.38€	Ø130	665-ZUWA9360130	34.15€	Ø130	665-ZUWA3070130	29.27€	Ø130	665-ZUWA939AL0130	219€	Ø130	665-ZUWA938AL0130	206€
Ø150	665-ZUWA420150	14.65€	Ø150	665-ZUWA9360150	40.87€	Ø150	665-ZUWA3070150	34.15€	Ø150	665-ZUWA939AL0150	233€	Ø150	665-ZUWA938AL0150	215€
Ø180	665-ZUWA420180	21.16€	Ø180	665-ZUWA9360180	50€	Ø180	665-ZUWA3070180	40.87€	Ø180	665-ZUWA939AL0180	250€	Ø180	665-ZUWA938AL0180	235€
Ø200	665-ZUWA420200	26.04€	Ø200	665-ZUWA9360200	56€	Ø200	665-ZUWA3070200	47.13€	Ø200	665-ZUWA939AL0200	269€	Ø200	665-ZUWA938AL0200	252€
Ø250	665-ZUWA420250	29.27€	Ø250	665-ZUWA9360250	73€	Ø250	665-ZUWA3070250	59€	Ø250	665-ZUWA939AL0250	305€	Ø250	665-ZUWA938AL0250	282€
Ø300	665-ZUWA420300	34.15€	Ø300	665-ZUWA9360300	84€	Ø300	665-ZUWA3070300	71€	Ø300	665-ZUWA939AL0300	332€	Ø300	665-ZUWA938AL0300	317€
Ø350	665-ZUWA420350	37.43€	Ø350	665-ZUWA9360350	95€	Ø350	665-ZUWA3070350	77€	Ø350	665-ZUWA939AL0350	387€	Ø350	665-ZUWA938AL0350	351€
Ø400	665-ZUWA420400	40.87€	Ø400	665-ZUWA9360400	104€	Ø400	665-ZUWA3070400	83€	Ø400	665-ZUWA939AL0400	433€	Ø400	665-ZUWA938AL0400	390€
Ø450	665-ZUWA420450	56€	Ø450	665-ZUWA9360450	144€	Ø450	665-ZUWA3070450	114€	Ø450	665-ZUWA939AL0450	492€	Ø450	665-ZUWA938AL0450	436€
Ø500	665-ZUWA420500	74€	Ø500	665-ZUWA9360500	186€	Ø500	665-ZUWA3070500	151€	Ø500	665-ZUWA939AL0500	549€	Ø500	665-ZUWA938AL0500	488€
Ø550	665-ZUWA420550	98€	Ø550	665-ZUWA9360550	241€	Ø550	665-ZUWA3070550	199€	Ø550	665-ZUWA939AL0550	607€	Ø550	665-ZUWA938AL0550	524€
Ø600	665-ZUWA420600	106€	Ø600	665-ZUWA9360600	264€	Ø600	665-ZUWA3070600	211€	Ø600	665-ZUWA939AL0600	661€	Ø600	665-ZUWA938AL0600	573€

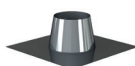

Cubreaguas plano inox

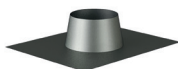

Cubreaguas plomo 0°-5°

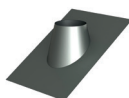

Cubreaguas plomo 25°-45°

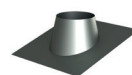

Cubreaguas plomo 5°-25°



Pasamuros

Ø80	665-ZUWA11280080	144€	Ø80	665-ZUWA9370080	203€	Ø80	665-ZUWA9390080	348€	Ø80	665-ZUWA9380080	203€	Ø80	665-ZUWA9870080	30.9€
Ø100	665-ZUWA11280100	145€	Ø100	665-ZUWA9370100	204€	Ø100	665-ZUWA9390100	356€	Ø100	665-ZUWA9380100	204€	Ø100	665-ZUWA9870100	37.43€
Ø130	665-ZUWA11280130	146€	Ø130	665-ZUWA9370130	205€	Ø130	665-ZUWA9390130	358€	Ø130	665-ZUWA9380130	205€	Ø130	665-ZUWA9870130	39.04€
Ø150	665-ZUWA11280150	150€	Ø150	665-ZUWA9370150	206€	Ø150	665-ZUWA9390150	363€	Ø150	665-ZUWA9380150	206€	Ø150	665-ZUWA9870150	40.87€
Ø180	665-ZUWA11280180	170€	Ø180	665-ZUWA9370180	234€	Ø180	665-ZUWA9390180	379€	Ø180	665-ZUWA9380180	234€	Ø180	665-ZUWA9870180	52€
Ø200	665-ZUWA11280200	185€	Ø200	665-ZUWA9370200	260€	Ø200	665-ZUWA9390200	386€	Ø200	665-ZUWA9380200	260€	Ø200	665-ZUWA9870200	52€
Ø250	665-ZUWA11280250	211€	Ø250	665-ZUWA9370250	294€	Ø250	665-ZUWA9390250	401€	Ø250	665-ZUWA9380250	294€	Ø250	665-ZUWA9870250	65€
Ø300	665-ZUWA11280300	233€	Ø300	665-ZUWA9370300	323€	Ø300	665-ZUWA9390300	417€	Ø300	665-ZUWA9380300	323€	Ø300	665-ZUWA9870300	83€
Ø350	665-ZUWA11280350	260€	Ø350	665-ZUWA9370350	361€	Ø350	665-ZUWA9390350	431€	Ø350	665-ZUWA9380350	361€	Ø350	665-ZUWA9870350	95€
Ø400	665-ZUWA11280400	286€	Ø400	665-ZUWA9370400	396€	Ø400	665-ZUWA9390400	454€	Ø400	665-ZUWA9380400	396€	Ø400	665-ZUWA9870400	121€
Ø450	665-ZUWA11280450	306€	Ø450	665-ZUWA9370450	428€	Ø450	665-ZUWA9390450	541€	Ø450	665-ZUWA9380450	428€	Ø450	665-ZUWA9870450	156€
Ø500	665-ZUWA11280500	352€	Ø500	665-ZUWA9370500	488€	Ø500	665-ZUWA9390500	618€	Ø500	665-ZUWA9380500	488€	Ø500	665-ZUWA9870500	204€
Ø550	665-ZUWA11280550	389€	Ø550	665-ZUWA9370550	539€	Ø550	665-ZUWA9390550	691€	Ø550	665-ZUWA9380550	539€	Ø550	665-ZUWA9870550	221€
Ø600	665-ZUWA11280600	437€	Ø600	665-ZUWA9370600	606€	Ø600	665-ZUWA9390600	775€	Ø600	665-ZUWA9380600	606€	Ø600	665-ZUWA9870600	244€

- i** Precio unidad. u/c= unidad caja.
- i** Necesario instalar collarín con el cubreaguas.
- i** Consultar página 91 para ver distancias de separación.



25 u/c  
**i**



Junta EPDM (T<120°C)

Sifón

Ø80	665-ZUWA26C0080	4.88€	Ø80	665-ZUWA2047	112€
Ø100	665-ZUWA26C0100	4.88€	Ø100	665-ZUWA2047	112€
Ø130	665-ZUWA26C0130	4.88€	Ø130	665-ZUWA2047	112€
Ø150	665-ZUWA26C0150	4.88€	Ø150	665-ZUWA2047	112€
Ø180	665-ZUWA26C0180	6.52€	Ø180	665-ZUWA2047	112€
Ø200	665-ZUWA26C0200	8.15€	Ø200	665-ZUWA2047	112€
Ø250	665-ZUWA26C0250	11.38€	Ø250	665-ZUWA2047	112€
Ø300	665-ZUWA26C0300	14.65€	Ø300	665-ZUWA2047	112€
Ø350	665-ZUWA26C0350	17.9€	Ø350	665-ZUWA2047	112€
Ø400	665-ZUWA26C0400	19.51€	Ø400	665-ZUWA2047	112€
Ø450	665-ZUWA26C0450	21.16€	Ø450	665-ZUWA2047	112€
Ø500	665-ZUWA26C0500	24.4€	Ø500	665-ZUWA2047	112€
Ø550	665-ZUWA26C0550	27.67€	Ø550	665-ZUWA2047	112€
Ø600	665-ZUWA26C0600	30.9€	Ø600	665-ZUWA2047	112€



GARANTÍA DE CERO FUGAS



Junta de condensación  
**INCLUIDA**



### CARACTERÍSTICAS

- Nueva junta específica para condensación con mejores prestaciones contra la corrosión.
- Diseño exclusivo de piecerío (codos, te's colectores...) para garantizar la estanqueidad al agua en cualquier situación.
- Disponibilidad de sifones preparados específicamente para las instalaciones de condensación sobrepresionadas.
- En tramadas horizontales es **OBLIGATORIA** la aplicación de 3° de inclinación.

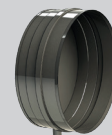
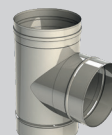
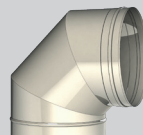



# CHIMENEA INDIVIDUAL

## Sistema EW - ECO CONDENSING

### ADAPTADOR CALDERA MACHO EXCÉNTRICO

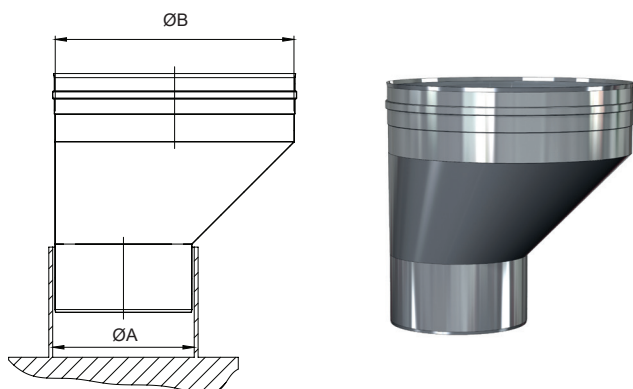

CÓDIGO	Ø A	Ø B	€
L02-EWEC37X00800080	Ø80	Ø80	35.77€
L02-EWEC37X00800100	Ø80	Ø100	88€
L02-EWEC37X00800130	Ø80	Ø130	90€
L02-EWEC37X01000080	Ø100	Ø80	83€
L02-EWEC37X01000100	Ø100	Ø100	84€
L02-EWEC37X01000130	Ø100	Ø130	84€
L02-EWEC37X01000150	Ø100	Ø150	36.8€
L02-EWEC37X01100080	Ø110	Ø80	85€
L02-EWEC37X01100100	Ø110	Ø100	101€
L02-EWEC37X01100130	Ø110	Ø130	84€
L02-EWEC37X01100150	Ø110	Ø150	85€
L02-EWEC37X01200080	Ø120	Ø80	85€
L02-EWEC37X01200100	Ø120	Ø100	101€
L02-EWEC37X01200130	Ø120	Ø130	85€
L02-EWEC37X01200150	Ø120	Ø150	85€
L02-EWEC37X01250080	Ø125	Ø80	85€
L02-EWEC37X01250100	Ø125	Ø100	101€
L02-EWEC37X01250130	Ø125	Ø130	85€
L02-EWEC37X01250150	Ø125	Ø150	85€
L02-EWEC37X01300080	Ø130	Ø80	39.98€
L02-EWEC37X01300100	Ø130	Ø100	101€
L02-EWEC37X01300130	Ø130	Ø130	85€
L02-EWEC37X01300150	Ø130	Ø150	85€
L02-EWEC37X01300180	Ø130	Ø180	39.98€
L02-EWEC37X01350100	Ø135	Ø100	103€
L02-EWEC37X01350130	Ø135	Ø130	122€
L02-EWEC37X01350150	Ø135	Ø150	105€
L02-EWEC37X01350180	Ø135	Ø180	39.98€
L02-EWEC37X01400100	Ø140	Ø100	103€
L02-EWEC37X01400130	Ø140	Ø130	122€
L02-EWEC37X01400150	Ø140	Ø150	105€
L02-EWEC37X01400180	Ø140	Ø180	106€
L02-EWEC37X01500100	Ø150	Ø100	45.92€
L02-EWEC37X01500130	Ø150	Ø130	122€
L02-EWEC37X01500150	Ø150	Ø150	105€
L02-EWEC37X01500180	Ø150	Ø180	106€
L02-EWEC37X01500200	Ø150	Ø200	45.92€
L02-EWEC37X01600130	Ø160	Ø130	122€
L02-EWEC37X01600150	Ø160	Ø150	138€
L02-EWEC37X01600180	Ø160	Ø180	130€
L02-EWEC37X01600200	Ø160	Ø200	45.92€
L02-EWEC37X01750130	Ø175	Ø130	122€
L02-EWEC37X01750150	Ø175	Ø150	138€
L02-EWEC37X01750180	Ø175	Ø180	130€

L02-EWEC37X01750200	Ø175	Ø200	124€
L02-EWEC37X01800130	Ø180	Ø130	55€
L02-EWEC37X01800150	Ø180	Ø150	138€
L02-EWEC37X01800180	Ø180	Ø180	130€
L02-EWEC37X01800200	Ø180	Ø200	124€
L02-EWEC37X01800250	Ø180	Ø250	55€
L02-EWEC37X02000150	Ø200	Ø150	143€
L02-EWEC37X02000180	Ø200	Ø180	153€
L02-EWEC37X02000200	Ø200	Ø200	143€
L02-EWEC37X02000250	Ø200	Ø250	143€
L02-EWEC37X02000300	Ø200	Ø300	63€
L02-EWEC37X02250180	Ø225	Ø180	156€
L02-EWEC37X02250200	Ø225	Ø200	207€
L02-EWEC37X02250250	Ø225	Ø250	148€
L02-EWEC37X02250300	Ø225	Ø300	151€
L02-EWEC37X02500180	Ø250	Ø180	156€
L02-EWEC37X02500200	Ø250	Ø200	207€
L02-EWEC37X02500250	Ø250	Ø250	148€
L02-EWEC37X02500300	Ø250	Ø300	151€
L02-EWEC37X02500350	Ø250	Ø350	83€
L02-EWEC37X03000200	Ø300	Ø200	209€
L02-EWEC37X03000250	Ø300	Ø250	208€
L02-EWEC37X03000300	Ø300	Ø300	198€
L02-EWEC37X03000350	Ø300	Ø350	207€
L02-EWEC37X03000400	Ø300	Ø400	98€
L02-EWEC37X03500250	Ø350	Ø250	214€
L02-EWEC37X03500300	Ø350	Ø300	240€
L02-EWEC37X03500350	Ø350	Ø350	238€
L02-EWEC37X03500400	Ø350	Ø400	249€
L02-EWEC37X03500450	Ø350	Ø450	106€
L02-EWEC37X04000300	Ø400	Ø300	252€
L02-EWEC37X04000350	Ø400	Ø350	397€
L02-EWEC37X04000400	Ø400	Ø400	278€
L02-EWEC37X04000450	Ø400	Ø450	250€
L02-EWEC37X04000500	Ø400	Ø500	115€
L02-EWEC37X04500350	Ø450	Ø350	403€
L02-EWEC37X04500400	Ø450	Ø400	538€
L02-EWEC37X04500450	Ø450	Ø450	338€
L02-EWEC37X04500500	Ø450	Ø500	345€
L02-EWEC37X04500550	Ø450	Ø550	162€
L02-EWEC37X05000400	Ø500	Ø400	550€
L02-EWEC37X05000450	Ø500	Ø450	981€
L02-EWEC37X05000500	Ø500	Ø500	347€
L02-EWEC37X05000550	Ø500	Ø550	418€
L02-EWEC37X05000600	Ø500	Ø600	230€
L02-EWEC37X05500450	Ø550	Ø450	993€
L02-EWEC37X05500500	Ø550	Ø500	1034€
L02-EWEC37X05500550	Ø550	Ø550	599€
L02-EWEC37X05500600	Ø550	Ø600	799€
L02-EWEC37X06000500	Ø600	Ø500	321€
L02-EWEC37X06000550	Ø600	Ø550	1049€
L02-EWEC37X06000600	Ø600	Ø600	832€

## TE 87° CON BOCA REDUCIDA (para instalación en cascada)

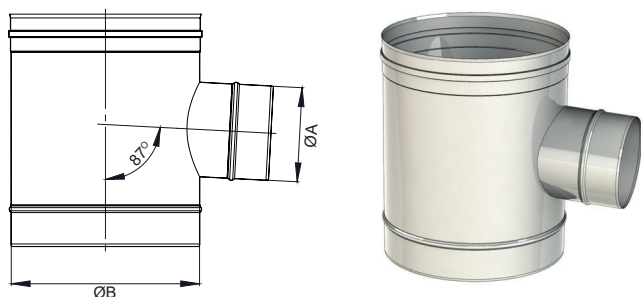

CÓDIGO	Ø A	Ø B	€
L02-EWECT87M00800100	Ø80	Ø100	117€
L02-EWECT87M00800130	Ø80	Ø130	138€
L02-EWECT87M00800150	Ø80	Ø150	130€
L02-EWECT87M00800180	Ø80	Ø180	157€
L02-EWECT87M00800200	Ø80	Ø200	167€
L02-EWECT87M00800250	Ø80	Ø250	209€
L02-EWECT87M00800300	Ø80	Ø300	252€
L02-EWECT87M00800350	Ø80	Ø350	299€
L02-EWECT87M00800400	Ø80	Ø400	308€
L02-EWECT87M00800450	Ø80	Ø450	355€
L02-EWECT87M00800500	Ø80	Ø500	540€
L02-EWECT87M00800550	Ø80	Ø550	655€
L02-EWECT87M00800600	Ø80	Ø600	819€
L02-EWECT87M01000130	Ø100	Ø130	934€
L02-EWECT87M01000150	Ø100	Ø150	130€
L02-EWECT87M01000180	Ø100	Ø180	157€
L02-EWECT87M01000200	Ø100	Ø200	167€
L02-EWECT87M01000250	Ø100	Ø250	209€
L02-EWECT87M01000300	Ø100	Ø300	252€
L02-EWECT87M01000350	Ø100	Ø350	299€
L02-EWECT87M01000400	Ø100	Ø400	308€
L02-EWECT87M01000450	Ø100	Ø450	355€
L02-EWECT87M01000500	Ø100	Ø500	540€
L02-EWECT87M01000550	Ø100	Ø550	655€
L02-EWECT87M01000600	Ø100	Ø600	819€
L02-EWECT87M01300150	Ø130	Ø150	934€
L02-EWECT87M01300180	Ø130	Ø180	157€
L02-EWECT87M01300200	Ø130	Ø200	167€
L02-EWECT87M01300250	Ø130	Ø250	209€
L02-EWECT87M01300300	Ø130	Ø300	252€
L02-EWECT87M01300350	Ø130	Ø350	299€
L02-EWECT87M01300400	Ø130	Ø400	308€
L02-EWECT87M01300450	Ø130	Ø450	355€
L02-EWECT87M01300500	Ø130	Ø500	540€
L02-EWECT87M01300550	Ø130	Ø550	655€
L02-EWECT87M01300600	Ø130	Ø600	819€
L02-EWECT87M01500180	Ø150	Ø180	934€
L02-EWECT87M01500200	Ø150	Ø200	167€
L02-EWECT87M01500250	Ø150	Ø250	209€
L02-EWECT87M01500300	Ø150	Ø300	252€
L02-EWECT87M01500350	Ø150	Ø350	299€
L02-EWECT87M01500400	Ø150	Ø400	308€
L02-EWECT87M01500450	Ø150	Ø450	355€
L02-EWECT87M01500500	Ø150	Ø500	540€

L02-EWECT87M01500550	Ø150	Ø550	655€
L02-EWECT87M01500600	Ø150	Ø600	819€
L02-EWECT87M01800200	Ø180	Ø200	934€
L02-EWECT87M01800250	Ø180	Ø250	209€
L02-EWECT87M01800300	Ø180	Ø300	252€
L02-EWECT87M01800350	Ø180	Ø350	299€
L02-EWECT87M01800400	Ø180	Ø400	308€
L02-EWECT87M01800450	Ø180	Ø450	355€
L02-EWECT87M01800500	Ø180	Ø500	540€
L02-EWECT87M01800550	Ø180	Ø550	655€
L02-EWECT87M01800600	Ø180	Ø600	819€
L02-EWECT87M02000250	Ø200	Ø250	934€
L02-EWECT87M02000300	Ø200	Ø300	252€
L02-EWECT87M02000350	Ø200	Ø350	299€
L02-EWECT87M02000400	Ø200	Ø400	308€
L02-EWECT87M02000450	Ø200	Ø450	355€
L02-EWECT87M02000500	Ø200	Ø500	540€
L02-EWECT87M02000550	Ø200	Ø550	655€
L02-EWECT87M02000600	Ø200	Ø600	819€
L02-EWECT87M02500300	Ø250	Ø300	934€
L02-EWECT87M02500350	Ø250	Ø350	299€
L02-EWECT87M02500400	Ø250	Ø400	308€
L02-EWECT87M02500450	Ø250	Ø450	355€
L02-EWECT87M02500500	Ø250	Ø500	540€
L02-EWECT87M02500550	Ø250	Ø550	655€
L02-EWECT87M02500600	Ø250	Ø600	819€
L02-EWECT87M03000350	Ø300	Ø350	934€
L02-EWECT87M03000400	Ø300	Ø400	308€
L02-EWECT87M03000450	Ø300	Ø450	355€
L02-EWECT87M03000500	Ø300	Ø500	540€
L02-EWECT87M03000550	Ø300	Ø550	655€
L02-EWECT87M03000600	Ø300	Ø600	819€
L02-EWECT87M03500400	Ø350	Ø400	934€
L02-EWECT87M03500450	Ø350	Ø450	355€
L02-EWECT87M03500500	Ø350	Ø500	540€
L02-EWECT87M03500550	Ø350	Ø550	655€
L02-EWECT87M03500600	Ø350	Ø600	819€
L02-EWECT87M04000450	Ø400	Ø450	934€
L02-EWECT87M04000500	Ø400	Ø500	540€
L02-EWECT87M04000550	Ø400	Ø550	655€
L02-EWECT87M04000600	Ø400	Ø600	819€
L02-EWECT87M04500500	Ø450	Ø500	934€
L02-EWECT87M04500550	Ø450	Ø550	655€
L02-EWECT87M04500600	Ø450	Ø600	819€
L02-EWECT87M05000550	Ø500	Ø550	934€
L02-EWECT87M05000600	Ø500	Ø600	819€
L02-EWECT87M05500600	Ø550	Ø600	934€



# CHIMENEA INDIVIDUAL

## Sistema EW - ECO 316

Chimenea modular metálica para evacuación de humos y gases de los productos de la combustión de simple pared fabricada en acero inoxidable.

### MATERIAL

AISI 316L

### ACABADO EXTERIOR

Brillante

Colores RAL hasta 200°C (consultar precios)

### ESPEORES (mm)

0,4 - 0,5 - 0,6 - 0,8 (según el diámetro)

### DIÁMETROS DISPONIBLES (mm)

Ø80 a Ø800

### SISTEMA DE UNIÓN

Conexión macho-hembra con **abrazadera de unión sencilla**

### NIVEL DE ESTANQUEIDAD

T--- N1: Sin necesidad de junta.

T200 - P1: con junta de estanqueidad (EW26Ø)\*.

Para incluir la junta de estanqueidad (T<200°C) preinstalada de fábrica sustituir el código 671 por L08\*. Excepto en terminales.

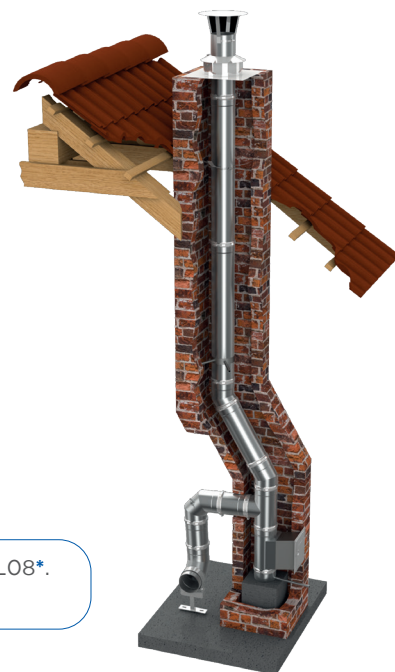

\*con junta de estanqueidad

### APLICACIONES

- Calderas y estufas de combustibles sólidos



### CARACTERÍSTICAS

- Instalación por patinillo interior
- Temperatura de trabajo hasta 600°C
- Soldadura TIG/LÁSER** en continuo en todas las piezas
- Abrazadera de unión **NO INCLUIDA**
- Posibilidad de **corte de módulos rectos a medida en obra**

### CERTIFICADO CE

0036 CPR 9174 029

### CLASIFICACIONES CE (UNE-EN 1856-1)

T600 - N1 - D - V2 - L50040 - G(100)

T400 - N1 - W - V2 - L50040 - O(50)

T200 - P1 - W - V2 - L50040 - O(00) (con junta de estanqueidad T<200°C)



Módulo recto 1000mm



Módulo recto 500mm



Módulo recto 250mm



Módulo recto regulable  
400-560mm



Módulo recto regulable  
560-920mm

Ø80	671-EWEC130080	44€	Ø80	671-EWEC140080	30.9€	Ø80	671-EWEC150080	22.77€	Ø80	671-EWEC5440080	73€	Ø80	671-EWEC5450080	87€
Ø100	671-EWEC130100	52€	Ø100	671-EWEC140100	32.52€	Ø100	671-EWEC150100	24.4€	Ø100	671-EWEC5440100	81€	Ø100	671-EWEC5450100	97€
Ø130	671-EWEC130130	71€	Ø130	671-EWEC140130	39.04€	Ø130	671-EWEC150130	27.67€	Ø130	671-EWEC5440130	90€	Ø130	671-EWEC5450130	107€
Ø150	671-EWEC130150	78€	Ø150	671-EWEC140150	42.42€	Ø150	671-EWEC150150	29.27€	Ø150	671-EWEC5440150	110€	Ø150	671-EWEC5450150	133€
Ø180	671-EWEC130180	91€	Ø180	671-EWEC140180	47.13€	Ø180	671-EWEC150180	30.9€	Ø180	671-EWEC5440180	132€	Ø180	671-EWEC5450180	157€
Ø200	671-EWEC130200	100€	Ø200	671-EWEC140200	56€	Ø200	671-EWEC150200	32.52€	Ø200	671-EWEC5440200	151€	Ø200	671-EWEC5450200	183€
Ø250	671-EWEC130250	132€	Ø250	671-EWEC140250	71€	Ø250	671-EWEC150250	37.43€	Ø250	671-EWEC5440250	185€	Ø250	671-EWEC5450250	221€
Ø300	671-EWEC130300	157€	Ø300	671-EWEC140300	83€	Ø300	671-EWEC150300	44€	Ø300	671-EWEC5440300	220€	Ø300	671-EWEC5450300	269€
Ø350	671-EWEC130350	211€	Ø350	671-EWEC140350	107€	Ø350	671-EWEC150350	50€	Ø350	671-EWEC5440350	244€	Ø350	671-EWEC5450350	294€
Ø400	671-EWEC130400	239€	Ø400	671-EWEC140400	117€	Ø400	671-EWEC150400	54€	Ø400	671-EWEC5440400	268€	Ø400	671-EWEC5450400	323€
Ø450	671-EWEC130450	290€	Ø450	671-EWEC140450	161€	Ø450	671-EWEC150450	84€	Ø450	671-EWEC5440450	327€	Ø450	671-EWEC5450450	358€
Ø500	671-EWEC130500	344€	Ø500	671-EWEC140500	212€	Ø500	671-EWEC150500	127€	Ø500	671-EWEC5440500	357€	Ø500	671-EWEC5450500	400€
Ø550	671-EWEC130550	397€	Ø550	671-EWEC140550	247€	Ø550	671-EWEC150550	151€	Ø550	671-EWEC5440550	387€	Ø550	671-EWEC5450550	447€
Ø600	671-EWEC130600	428€	Ø600	671-EWEC140600	256€	Ø600	671-EWEC150600	152€	Ø600	671-EWEC5440600	417€	Ø600	671-EWEC5450600	488€
Ø650	671-EWEC130650	453€	Ø650	671-EWEC140650	269€	Ø650	671-EWEC150650	155€	Ø650	671-EWEC5440650	439€	Ø650	671-EWEC5450650	511€
Ø700	671-EWEC130700	565€	Ø700	671-EWEC140700	335€	Ø700	671-EWEC150700	191€	Ø700	671-EWEC5440700	550€	Ø700	671-EWEC5450700	640€
Ø750	671-EWEC130750	590€	Ø750	671-EWEC140750	351€	Ø750	671-EWEC150750	202€	Ø750	671-EWEC5440750	570€	Ø750	671-EWEC5450750	666€
Ø800	671-EWEC130800	640€	Ø800	671-EWEC140800	380€	Ø800	671-EWEC150800	219€	Ø800	671-EWEC5440800	621€	Ø800	671-EWEC5450800	729€



Módulo de descenso



Codo 15°



Codo 30°



Codo 45°



Codo 60°

Ø80	671-EWEC14680080	71€	Ø80	671-EWEC160080	22.77€	Ø80	671-EWEC170080	22.77€	Ø80	671-EWEC180080	22.77€	Ø80	671-EWEC840080	30.9€
Ø100	671-EWEC14680100	84€	Ø100	671-EWEC160100	24.4€	Ø100	671-EWEC170100	24.4€	Ø100	671-EWEC180100	24.4€	Ø100	671-EWEC840100	32.52€
Ø130	671-EWEC14680130	111€	Ø130	671-EWEC160130	29.27€	Ø130	671-EWEC170130	29.27€	Ø130	671-EWEC180130	29.27€	Ø130	671-EWEC840130	37.43€
Ø150	671-EWEC14680150	123€	Ø150	671-EWEC160150	37.43€	Ø150	671-EWEC170150	37.43€	Ø150	671-EWEC180150	37.43€	Ø150	671-EWEC840150	45.58€
Ø180	671-EWEC14680180	146€	Ø180	671-EWEC160180	45.58€	Ø180	671-EWEC170180	45.58€	Ø180	671-EWEC180180	45.58€	Ø180	671-EWEC840180	54€
Ø200	671-EWEC14680200	166€	Ø200	671-EWEC160200	52€	Ø200	671-EWEC170200	52€	Ø200	671-EWEC180200	52€	Ø200	671-EWEC840200	66€
Ø250	671-EWEC14680250	215€	Ø250	671-EWEC160250	62€	Ø250	671-EWEC170250	62€	Ø250	671-EWEC180250	62€	Ø250	671-EWEC840250	81€
Ø300	671-EWEC14680300	256€	Ø300	671-EWEC160300	90€	Ø300	671-EWEC170300	90€	Ø300	671-EWEC180300	90€	Ø300	671-EWEC840300	109€
Ø350	671-EWEC14680350	344€	Ø350	671-EWEC160350	123€	Ø350	671-EWEC170350	123€	Ø350	671-EWEC180350	123€	Ø350	671-EWEC840350	143€
Ø400	671-EWEC14680400	389€	Ø400	671-EWEC160400	150€	Ø400	671-EWEC170400	150€	Ø400	671-EWEC180400	150€	Ø400	671-EWEC840400	168€
Ø450	671-EWEC14680450	472€	Ø450	671-EWEC160450	220€	Ø450	671-EWEC170450	220€	Ø450	671-EWEC180450	220€	Ø450	671-EWEC840450	249€
Ø500	671-EWEC14680500	565€	Ø500	671-EWEC160500	252€	Ø500	671-EWEC170500	252€	Ø500	671-EWEC180500	252€	Ø500	671-EWEC840500	280€
Ø550	671-EWEC14680550	648€	Ø550	671-EWEC160550	296€	Ø550	671-EWEC170550	296€	Ø550	671-EWEC180550	296€	Ø550	671-EWEC840550	311€
Ø600	671-EWEC14680600	701€	Ø600	671-EWEC160600	319€	Ø600	671-EWEC170600	319€	Ø600	671-EWEC180600	319€	Ø600	671-EWEC840600	335€
Ø650	671-EWEC14680650	741€	Ø650	671-EWEC160650	333€	Ø650	671-EWEC170650	333€	Ø650	671-EWEC180650	333€			
Ø700	671-EWEC14680700	923€	Ø700	671-EWEC160700	416€	Ø700	671-EWEC170700	416€	Ø700	671-EWEC180700	416€			
Ø750	671-EWEC14680750	964€	Ø750	671-EWEC160750	430€	Ø750	671-EWEC170750	430€	Ø750	671-EWEC180750	430€			
Ø800	671-EWEC14680800	1052€	Ø800	671-EWEC160800	471€	Ø800	671-EWEC170800	471€	Ø800	671-EWEC180800	471€			



# CHIMENEA INDIVIDUAL

## Sistema EW - ECO 316



Codo 90°



Codo 0°-90°  
Multidireccional



Te 90°



Te 135°



Colector de hollín

Ø80	671-EWEC600080	32.52€	Ø80	671-EWEC1010080	73€	Ø80	671-EWEC3170080	67€	Ø80	671-EWEC120080	81€	Ø80	671-EWEC5510080	30.9€
Ø100	671-EWEC600100	37.43€	Ø100	671-EWEC1010100	73€	Ø100	671-EWEC3170100	78€	Ø100	671-EWEC120100	90€	Ø100	671-EWEC5510100	32.52€
Ø130	671-EWEC600130	42.42€	Ø130	671-EWEC1010130	84€	Ø130	671-EWEC3170130	91€	Ø130	671-EWEC120130	96€	Ø130	671-EWEC5510130	39.04€
Ø150	671-EWEC600150	50€	Ø150	671-EWEC1010150	100€	Ø150	671-EWEC3170150	109€	Ø150	671-EWEC120150	119€	Ø150	671-EWEC5510150	42.42€
Ø180	671-EWEC600180	62€	Ø180	671-EWEC1010180	121€	Ø180	671-EWEC3170180	111€	Ø180	671-EWEC120180	140€	Ø180	671-EWEC5510180	48.72€
Ø200	671-EWEC600200	74€	Ø200	671-EWEC1010200	139€	Ø200	671-EWEC3170200	141€	Ø200	671-EWEC120200	161€	Ø200	671-EWEC5510200	52€
Ø250	671-EWEC600250	95€	Ø250	671-EWEC1010250	168€	Ø250	671-EWEC3170250	168€	Ø250	671-EWEC120250	200€	Ø250	671-EWEC5510250	62€
Ø300	671-EWEC600300	121€				Ø300	671-EWEC3170300	199€	Ø300	671-EWEC120300	251€	Ø300	671-EWEC5510300	78€
Ø350	671-EWEC600350	161€				Ø350	671-EWEC3170350	236€	Ø350	671-EWEC120350	275€	Ø350	671-EWEC5510350	95€
Ø400	671-EWEC600400	185€				Ø400	671-EWEC3170400	271€	Ø400	671-EWEC120400	304€	Ø400	671-EWEC5510400	122€
Ø450	671-EWEC600450	272€				Ø450	671-EWEC3170450	424€	Ø450	671-EWEC120450	471€	Ø450	671-EWEC5510450	168€
Ø500	671-EWEC600500	306€				Ø500	671-EWEC3170500	516€	Ø500	671-EWEC120500	550€	Ø500	671-EWEC5510500	180€
Ø550	671-EWEC600550	338€				Ø550	671-EWEC3170550	652€	Ø550	671-EWEC120550	685€	Ø550	671-EWEC5510550	244€
Ø600	671-EWEC600600	369€				Ø600	671-EWEC3170600	739€	Ø600	671-EWEC120600	1586€	Ø600	671-EWEC5510600	252€
						Ø650	671-EWEC3170650	780€	Ø650	671-EWEC120650	1676€	Ø650	671-EWEC5510650	267€
						Ø700	671-EWEC3170700	967€	Ø700	671-EWEC120700	2086€	Ø700	671-EWEC5510700	333€
						Ø750	671-EWEC3170750	1012€	Ø750	671-EWEC120750	2182€	Ø750	671-EWEC5510750	343€
						Ø800	671-EWEC3170800	1102€	Ø800	671-EWEC120800	2375€	Ø800	671-EWEC5510800	375€

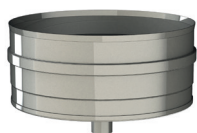

Colector de hollín con  
desagüe



Codo 90° con tapa de  
inspección P1



Módulo de inspección



Módulo de inspección con  
tapa 200 Pa (P1)



Módulo de inspección con  
tapa 40 Pa (N1)

Ø80	671-EWEC440080	39.04€	Ø80	671-EWEC19AL0080	99€	Ø80	671-EWEC5430080	40.87€	Ø80	671-EWEC5490080	142€	Ø80	671-EWEC680080	83€
Ø100	671-EWEC440100	42.42€	Ø100	671-EWEC19AL0100	119€	Ø100	671-EWEC5430100	45.58€	Ø100	671-EWEC5490100	155€	Ø100	671-EWEC680100	90€
Ø130	671-EWEC440130	47.13€	Ø130	671-EWEC19AL0130	129€	Ø130	671-EWEC5430130	48.72€	Ø130	671-EWEC5490130	166€	Ø130	671-EWEC680130	100€
Ø150	671-EWEC440150	48.72€	Ø150	671-EWEC19AL0150	163€	Ø150	671-EWEC5430150	62€	Ø150	671-EWEC5490150	170€	Ø150	671-EWEC680150	123€
Ø180	671-EWEC440180	50€	Ø180	671-EWEC19AL0180	200€	Ø180	671-EWEC5430180	74€	Ø180	671-EWEC5490180	179€	Ø180	671-EWEC680180	151€
Ø200	671-EWEC440200	52€	Ø200	671-EWEC19AL0200	245€	Ø200	671-EWEC5430200	83€	Ø200	671-EWEC5490200	187€	Ø200	671-EWEC680200	170€
Ø250	671-EWEC440250	73€	Ø250	671-EWEC19AL0250	289€	Ø250	671-EWEC5430250	100€	Ø250	671-EWEC5490250	221€	Ø250	671-EWEC680250	211€
Ø300	671-EWEC440300	87€	Ø300	671-EWEC19AL0300	322€	Ø300	671-EWEC5430300	121€	Ø300	671-EWEC5490300	242€	Ø300	671-EWEC680300	251€
Ø350	671-EWEC440350	107€	Ø350	671-EWEC19AL0350	386€	Ø350	671-EWEC5430350	132€	Ø350	671-EWEC5490350	280€	Ø350	671-EWEC680350	274€
Ø400	671-EWEC440400	186€	Ø400	671-EWEC19AL0400	458€	Ø400	671-EWEC5430400	143€	Ø400	671-EWEC5490400	400€	Ø400	671-EWEC680400	304€
Ø450	671-EWEC440450	239€	Ø450	671-EWEC19AL0450	702€	Ø450	671-EWEC5430450	206€	Ø450	671-EWEC5490450	432€	Ø450	671-EWEC680450	427€
Ø500	671-EWEC440500	271€	Ø500	671-EWEC19AL0500	802€	Ø500	671-EWEC5430500	244€	Ø500	671-EWEC5490500	439€	Ø500	671-EWEC680500	562€
Ø550	671-EWEC440550	294€	Ø550	671-EWEC19AL0550	971€	Ø550	671-EWEC5430550	256€	Ø550	671-EWEC5490550	460€	Ø550	671-EWEC680550	729€
Ø600	671-EWEC440600	298€	Ø600	671-EWEC19AL0600	1158€	Ø600	671-EWEC5430600	272€	Ø600	671-EWEC5490600	531€	Ø600	671-EWEC680600	787€
Ø650	671-EWEC440650	316€				Ø650	671-EWEC5430650	287€	Ø650	671-EWEC5490650	543€	Ø650	671-EWEC680650	829€
Ø700	671-EWEC440700	391€				Ø700	671-EWEC5430700	358€	Ø700	671-EWEC5490700	550€	Ø700	671-EWEC680700	1031€
Ø750	671-EWEC440750	410€				Ø750	671-EWEC5430750	369€	Ø750	671-EWEC5490750	570€	Ø750	671-EWEC680750	1079€
Ø800	671-EWEC440800	449€				Ø800	671-EWEC5430800	408€	Ø800	671-EWEC5490800	621€	Ø800	671-EWEC680800	1172€



En los diámetros Ø80 y Ø100 las lamas sobresalen del diámetro del tubo.



Para ángulos diferentes de 90° se produce un cierto desplazamiento del eje.

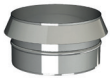

Terminal salida libre



Terminal anti-lluvia



Terminal anti-viento

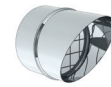

Terminal horizontal con rejilla



Terminal Gas

Ø80	671-EWEC320080	58€	Ø80	671-EWEC5260080	80€	Ø80	671-EWEC5270080	119€	Ø80	671-EWEC5320080	66€	Ø130	671-EWEC14540130	338€
Ø100	671-EWEC320100	65€	Ø100	671-EWEC5260100	90€	Ø100	671-EWEC5270100	132€	Ø100	671-EWEC5320100	73€	Ø150	671-EWEC14540150	378€
Ø130	671-EWEC320130	73€	Ø130	671-EWEC5260130	99€	Ø130	671-EWEC5270130	143€	Ø130	671-EWEC5320130	81€	Ø180	671-EWEC14540180	417€
Ø150	671-EWEC320150	90€	Ø150	671-EWEC5260150	123€	Ø150	671-EWEC5270150	183€	Ø150	671-EWEC5320150	99€	Ø200	671-EWEC14540200	527€
Ø180	671-EWEC320180	107€	Ø180	671-EWEC5260180	150€	Ø180	671-EWEC5270180	212€	Ø180	671-EWEC5320180	121€	Ø250	671-EWEC14540250	642€
Ø200	671-EWEC320200	121€	Ø200	671-EWEC5260200	170€	Ø200	671-EWEC5270200	247€	Ø200	671-EWEC5320200	138€	Ø300	671-EWEC14540300	732€
Ø250	671-EWEC320250	150€	Ø250	671-EWEC5260250	210€	Ø250	671-EWEC5270250	304€	Ø250	671-EWEC5320250	168€	Ø350	671-EWEC14540350	963€
Ø300	671-EWEC320300	178€	Ø300	671-EWEC5260300	250€	Ø300	671-EWEC5270300	364€	Ø300	671-EWEC5320300	202€	Ø400	671-EWEC14540400	1072€
Ø350	671-EWEC320350	196€	Ø350	671-EWEC5260350	274€	Ø350	671-EWEC5270350	425€	Ø350	671-EWEC5320350	219€	Ø450	671-EWEC14540450	1300€
Ø400	671-EWEC320400	215€	Ø400	671-EWEC5260400	303€	Ø400	671-EWEC5270400	533€	Ø400	671-EWEC5320400	242€	Ø500	671-EWEC14540500	1651€
Ø450	671-EWEC320450	269€							Ø450	671-EWEC5320450	303€	Ø550	671-EWEC14540550	1852€
Ø500	671-EWEC320500	289€							Ø500	671-EWEC5320500	327€	Ø600	671-EWEC14540600	2044€
Ø550	671-EWEC320550	368€							Ø550	671-EWEC5320550	417€	Ø650	671-EWEC14540650	2164€
Ø600	671-EWEC320600	398€							Ø600	671-EWEC5320600	452€	Ø700	671-EWEC14540700	2691€
Ø650	671-EWEC320650	417€							Ø650	671-EWEC5320650	472€	Ø750	671-EWEC14540750	2813€
Ø700	671-EWEC320700	521€							Ø700	671-EWEC5320700	591€	Ø800	671-EWEC14540800	3066€
Ø750	671-EWEC320750	542€							Ø750	671-EWEC5320750	616€			
Ø800	671-EWEC320800	592€							Ø800	671-EWEC5320800	667€			



Terminal GAS light



Regulador de tiro



Estabilizador de tiro (adaptador + clapeta)



Adaptador a Hurricane

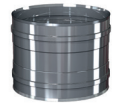

Manguito hembra-hembra

Ø80	671-EWEC43500080	219€	Ø80	671-EWEC5310080	140€	Ø80	671-EWEC9700080	190€	Ø130	671-EWEC44760130	88€	Ø80	671-EWEC6130080	14.65€
Ø100	671-EWEC43500100	235€	Ø100	671-EWEC5310100	139€	Ø100	671-EWEC9700100	200€	Ø150	671-EWEC44760150	88€	Ø100	671-EWEC6130100	22.77€
Ø130	671-EWEC43500130	252€	Ø130	671-EWEC5310130	139€	Ø130	671-EWEC9700130	204€	Ø180	671-EWEC44760180	99€	Ø130	671-EWEC6130130	27.67€
Ø150	671-EWEC43500150	295€	Ø150	671-EWEC5310150	161€	Ø150	671-EWEC9700150	235€	Ø200	671-EWEC44760200	129€	Ø150	671-EWEC6130150	32.52€
Ø180	671-EWEC43500180	322€	Ø180	671-EWEC5310180	184€	Ø180	671-EWEC9700180	244€	Ø250	671-EWEC44760250	150€	Ø180	671-EWEC6130180	42.42€
Ø200	671-EWEC43500200	358€	Ø200	671-EWEC5310200	211€	Ø200	671-EWEC9700200	271€	Ø300	671-EWEC44760300	191€	Ø200	671-EWEC6130200	44€
Ø250	671-EWEC43500250	473€	Ø250	671-EWEC5310250	300€	Ø250	671-EWEC9700250	290€				Ø250	671-EWEC6130250	48.72€
Ø300	671-EWEC43500300	616€	Ø300	671-EWEC5310300	406€	Ø300	671-EWEC9700300	335€				Ø300	671-EWEC6130300	54€
			Ø350	671-EWEC5310350	462€	Ø350	671-EWEC9700350	361€				Ø350	671-EWEC6130350	66€
			Ø400	671-EWEC5310400	598€	Ø400	671-EWEC9700400	369€				Ø400	671-EWEC6130400	90€
			Ø450	671-EWEC5310450	698€	Ø450	671-EWEC9700450	390€				Ø450	671-EWEC6130450	101€
			Ø500	671-EWEC5310500	806€	Ø500	671-EWEC9700500	410€				Ø500	671-EWEC6130500	129€
			Ø550	671-EWEC5310550	829€	Ø550	671-EWEC9700550	413€				Ø550	671-EWEC6130550	206€
			Ø600	671-EWEC5310600	801€	Ø600	671-EWEC9700600	438€				Ø600	671-EWEC6130600	236€
			Ø650	671-EWEC5310650	936€	Ø650	671-EWEC9700650	458€				Ø650	671-EWEC6130650	245€
			Ø700	671-EWEC5310700	1153€	Ø700	671-EWEC9700700	572€				Ø700	671-EWEC6130700	305€
			Ø750	671-EWEC5310750	1331€	Ø750	671-EWEC9700750	597€				Ø750	671-EWEC6130750	319€
			Ø800	671-EWEC5310800	1624€	Ø800	671-EWEC9700800	653€				Ø800	671-EWEC6130800	344€



# CHIMENEA INDIVIDUAL

## Sistema EW - ECO 316



Manguito macho-macho



Soporte de carga regulable

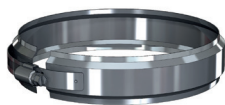

Abrazadera de unión 1.0

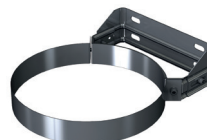

Abrazadera fijación pared regulable 50-80mm



Abrazadera fijación pared fija

Ø80	671-EWEC9720080	14.65€	Ø80	671-EWEC3790080	67€	Ø80	665-ZUWA450080	6.52€	Ø80	665-ZUWA5560080	30.9€	Ø450	665-ZUWA556F0450	118€
Ø100	671-EWEC9720100	22.77€	Ø100	671-EWEC3790100	76€	Ø100	665-ZUWA450100	6.52€	Ø100	665-ZUWA5560100	34.15€	Ø500	665-ZUWA556F0500	123€
Ø130	671-EWEC9720130	29.27€	Ø130	671-EWEC3790130	83€	Ø130	665-ZUWA450130	6.52€	Ø130	665-ZUWA5560130	37.43€	Ø550	665-ZUWA556F0550	155€
Ø150	671-EWEC9720150	32.52€	Ø150	671-EWEC3790150	100€	Ø150	665-ZUWA450150	8.15€	Ø150	665-ZUWA5560150	39.04€	Ø600	665-ZUWA556F0600	185€
Ø180	671-EWEC9720180	42.42€	Ø180	671-EWEC3790180	123€	Ø180	665-ZUWA450180	9.75€	Ø180	665-ZUWA5560180	39.04€	Ø650	665-ZUWA556F0650	203€
Ø200	671-EWEC9720200	44€	Ø200	671-EWEC3790200	139€	Ø200	665-ZUWA450200	11.38€	Ø200	665-ZUWA5560200	45.58€	Ø700	665-ZUWA556F0700	264€
Ø250	671-EWEC9720250	48.72€	Ø250	671-EWEC3790250	172€	Ø250	665-ZUWA450250	21.16€	Ø250	665-ZUWA5560250	61€	Ø750	665-ZUWA556F0750	321€
Ø300	671-EWEC9720300	54€	Ø300	671-EWEC3790300	206€	Ø300	665-ZUWA450300	26.04€	Ø300	665-ZUWA5560300	64€	Ø800	665-ZUWA556F0800	358€
Ø350	671-EWEC9720350	66€	Ø350	671-EWEC3790350	222€	Ø350	665-ZUWA450350	29.27€	Ø350	665-ZUWA5560350	67€			
Ø400	671-EWEC9720400	90€	Ø400	671-EWEC3790400	247€	Ø400	665-ZUWA450400	37.43€	Ø400	665-ZUWA5560400	88€			
Ø450	671-EWEC9720450	101€	Ø450	671-EWEC3790450	364€	Ø450	665-ZUWA450450	42.42€	Ø450	665-ZUWA5560450	98€			
Ø500	671-EWEC9720500	129€	Ø500	671-EWEC3790500	510€	Ø500	665-ZUWA450500	47.13€						
Ø550	671-EWEC9720550	206€	Ø550	671-EWEC3790550	744€	Ø550	665-ZUWA450550	50€						
Ø600	671-EWEC9720600	236€	Ø600	671-EWEC3790600	803€	Ø600	665-ZUWA450600	59€						
Ø650	671-EWEC9720650	245€	Ø650	671-EWEC3790650	849€	Ø650	665-ZUWA450650	64€						
Ø700	671-EWEC9720700	305€	Ø700	671-EWEC3790700	1055€	Ø700	665-ZUWA450700	77€						
Ø750	671-EWEC9720750	319€	Ø750	671-EWEC3790750	1102€	Ø750	665-ZUWA450750	95€						
Ø800	671-EWEC9720800	344€	Ø800	671-EWEC3790800	1201€	Ø800	665-ZUWA450800	104€						



Abrazadera fijación pared sencilla



Base de abrazadera distanciadora



Alas distanciadoras A



Alas distanciadoras B



Alas distanciadoras C

Ø80	665-ZUWA5350080	11.38€	Ø80	665-ZUWA14620080	39.04€	Ø80	665-ZUWA1462A	47.13€	Ø80	665-ZUWA1462B	65€	Ø80	665-ZUWA1462C	81€
Ø100	665-ZUWA5350100	14.65€	Ø100	665-ZUWA14620100	40.87€	Ø100	665-ZUWA1462A	47.13€	Ø100	665-ZUWA1462B	65€	Ø100	665-ZUWA1462C	81€
Ø130	665-ZUWA5350130	14.65€	Ø130	665-ZUWA14620130	45.58€	Ø130	665-ZUWA1462A	47.13€	Ø130	665-ZUWA1462B	65€	Ø130	665-ZUWA1462C	81€
Ø150	665-ZUWA5350150	19.51€	Ø150	665-ZUWA14620150	48.72€	Ø150	665-ZUWA1462A	47.13€	Ø150	665-ZUWA1462B	65€	Ø150	665-ZUWA1462C	81€
Ø180	665-ZUWA5350180	26.04€	Ø180	665-ZUWA14620180	52€	Ø180	665-ZUWA1462A	47.13€	Ø180	665-ZUWA1462B	65€	Ø180	665-ZUWA1462C	81€
Ø200	665-ZUWA5350200	29.27€	Ø200	665-ZUWA14620200	58€	Ø200	665-ZUWA1462A	47.13€	Ø200	665-ZUWA1462B	65€	Ø200	665-ZUWA1462C	81€
			Ø250	665-ZUWA14620250	100€	Ø250	665-ZUWA1462A	47.13€	Ø250	665-ZUWA1462B	65€	Ø250	665-ZUWA1462C	81€
			Ø300	665-ZUWA14620300	138€	Ø300	665-ZUWA1462A	47.13€	Ø300	665-ZUWA1462B	65€	Ø300	665-ZUWA1462C	81€
			Ø350	665-ZUWA14620350	185€	Ø350	665-ZUWA1462A	47.13€	Ø350	665-ZUWA1462B	65€	Ø350	665-ZUWA1462C	81€
			Ø400	665-ZUWA14620400	241€	Ø400	665-ZUWA1462A	47.13€	Ø400	665-ZUWA1462B	65€	Ø400	665-ZUWA1462C	81€
			Ø450	665-ZUWA14620450	298€	Ø450	665-ZUWA1462A	47.13€	Ø450	665-ZUWA1462B	65€	Ø450	665-ZUWA1462C	81€
			Ø500	665-ZUWA14620500	328€	Ø500	665-ZUWA1462A	47.13€	Ø500	665-ZUWA1462B	65€	Ø500	665-ZUWA1462C	81€
			Ø550	665-ZUWA14620550	365€	Ø550	665-ZUWA1462A	47.13€	Ø550	665-ZUWA1462B	65€	Ø550	665-ZUWA1462C	81€
			Ø600	665-ZUWA14620600	412€	Ø600	665-ZUWA1462A	47.13€	Ø600	665-ZUWA1462B	65€	Ø600	665-ZUWA1462C	81€
			Ø650	665-ZUWA14620650	444€	Ø650	665-ZUWA1462A	47.13€	Ø650	665-ZUWA1462B	65€	Ø650	665-ZUWA1462C	81€
			Ø700	665-ZUWA14620700	572€	Ø700	665-ZUWA1462A	47.13€	Ø700	665-ZUWA1462B	65€	Ø700	665-ZUWA1462C	81€
			Ø750	665-ZUWA14620750	587€	Ø750	665-ZUWA1462A	47.13€	Ø750	665-ZUWA1462B	65€	Ø750	665-ZUWA1462C	81€
			Ø800	665-ZUWA14620800	786€	Ø800	665-ZUWA1462A	47.13€	Ø800	665-ZUWA1462B	65€	Ø800	665-ZUWA1462C	81€



Consultar página 91 para ver distancias de separación.



Alas distanciadoras D



Abrazadera de descenso



Abrazadera de araña



Abrazadera de soporte



Abrazadera con doble pértiga telescópica L=2000mm

Ø80	665-ZUWA1462D	104€	Ø80	665-ZUWA40D0080	14.65€	Ø80	665-ZUWA400080	9.75€	Ø180	665-ZUWA8580180	145€	Ø130	665-ZUWA1910130	144€
Ø100	665-ZUWA1462D	104€	Ø100	665-ZUWA40D0100	14.65€	Ø100	665-ZUWA400100	9.75€	Ø200	665-ZUWA8580200	145€	Ø150	665-ZUWA1910150	146€
Ø130	665-ZUWA1462D	104€	Ø130	665-ZUWA40D0130	14.65€	Ø130	665-ZUWA400130	9.75€	Ø250	665-ZUWA8580250	185€	Ø180	665-ZUWA1910180	156€
Ø150	665-ZUWA1462D	104€	Ø150	665-ZUWA40D0150	19.51€	Ø150	665-ZUWA400150	9.75€	Ø300	665-ZUWA8580300	203€	Ø200	665-ZUWA1910200	173€
Ø180	665-ZUWA1462D	104€	Ø180	665-ZUWA40D0180	24.4€	Ø180	665-ZUWA400180	14.65€	Ø350	665-ZUWA8580350	221€	Ø250	665-ZUWA1910250	196€
Ø200	665-ZUWA1462D	104€	Ø200	665-ZUWA40D0200	27.67€	Ø200	665-ZUWA400200	14.65€	Ø400	665-ZUWA8580400	270€	Ø300	665-ZUWA1910300	233€
Ø250	665-ZUWA1462D	104€	Ø250	665-ZUWA40D0250	40.87€	Ø250	665-ZUWA400250	26.04€	Ø450	665-ZUWA8580450	321€	Ø350	665-ZUWA1910350	249€
Ø300	665-ZUWA1462D	104€	Ø300	665-ZUWA40D0300	48.72€	Ø300	665-ZUWA400300	29.27€	Ø500	665-ZUWA8580500	354€	Ø400	665-ZUWA1910400	272€
Ø350	665-ZUWA1462D	104€	Ø350	665-ZUWA40D0350	56€	Ø350	665-ZUWA400350	34.15€	Ø550	665-ZUWA8580550	401€	Ø450	665-ZUWA1910450	380€
Ø400	665-ZUWA1462D	104€	Ø400	665-ZUWA40D0400	74€	Ø400	665-ZUWA400400	37.43€	Ø600	665-ZUWA8580600	454€	Ø500	665-ZUWA1910500	496€
Ø450	665-ZUWA1462D	104€	Ø450	665-ZUWA40D0450	84€	Ø450	665-ZUWA400450	40.87€	Ø650	665-ZUWA8580650	492€	Ø550	665-ZUWA1910550	647€
Ø500	665-ZUWA1462D	104€	Ø500	665-ZUWA40D0500	95€	Ø500	665-ZUWA400500	56€	Ø700	665-ZUWA8580700	637€	Ø600	665-ZUWA1910600	699€
Ø550	665-ZUWA1462D	104€	Ø550	665-ZUWA40D0550	99€	Ø550	665-ZUWA400550	74€	Ø750	665-ZUWA8580750	780€	Ø650	665-ZUWA1910650	766€
Ø600	665-ZUWA1462D	104€	Ø600	665-ZUWA40D0600	117€	Ø600	665-ZUWA400600	98€	Ø800	665-ZUWA8580800	870€	Ø700	665-ZUWA1910700	871€
Ø650	665-ZUWA1462D	104€	Ø650	665-ZUWA40D0650	123€	Ø650	665-ZUWA400650	106€				Ø750	665-ZUWA1910750	976€
Ø700	665-ZUWA1462D	104€	Ø700	665-ZUWA40D0700	151€	Ø700	665-ZUWA400700	138€				Ø800	665-ZUWA1910800	1127€
Ø750	665-ZUWA1462D	104€	Ø750	665-ZUWA40D0750	185€	Ø750	665-ZUWA400750	166€						
Ø800	665-ZUWA1462D	104€	Ø800	665-ZUWA40D0800	205€	Ø800	665-ZUWA400800	186€						



Abrazadera forjado inox



Abrazadera para amarre por tornillo



Abrazadera vientos



Soporte de techo



Collarín antitormenta

Ø80	665-ZUWA620080	17.9€	Ø80	665-ZUWA10630080	26.04€	Ø80	665-ZUWA420080	9.75€	Ø80	665-ZUWA9360080	29.27€	Ø80	665-ZUWA3070080	26.04€
Ø100	665-ZUWA620100	21.16€	Ø100	665-ZUWA10630100	29.27€	Ø100	665-ZUWA420100	9.75€	Ø100	665-ZUWA9360100	32.52€	Ø100	665-ZUWA3070100	27.67€
Ø130	665-ZUWA620130	26.04€	Ø130	665-ZUWA10630130	32.52€	Ø130	665-ZUWA420130	11.38€	Ø130	665-ZUWA9360130	34.15€	Ø130	665-ZUWA3070130	29.27€
Ø150	665-ZUWA620150	30.9€	Ø150	665-ZUWA10630150	35.77€	Ø150	665-ZUWA420150	14.65€	Ø150	665-ZUWA9360150	40.87€	Ø150	665-ZUWA3070150	34.15€
Ø180	665-ZUWA620180	42.42€	Ø180	665-ZUWA10630180	39.04€	Ø180	665-ZUWA420180	21.16€	Ø180	665-ZUWA9360180	50€	Ø180	665-ZUWA3070180	40.87€
Ø200	665-ZUWA620200	47.13€	Ø200	665-ZUWA10630200	42.42€	Ø200	665-ZUWA420200	26.04€	Ø200	665-ZUWA9360200	56€	Ø200	665-ZUWA3070200	47.13€
Ø250	665-ZUWA620250	50€	Ø250	665-ZUWA10630250	50€	Ø250	665-ZUWA420250	29.27€	Ø250	665-ZUWA9360250	73€	Ø250	665-ZUWA3070250	59€
Ø300	665-ZUWA620300	59€	Ø300	665-ZUWA10630300	65€	Ø300	665-ZUWA420300	34.15€	Ø300	665-ZUWA9360300	84€	Ø300	665-ZUWA3070300	71€
Ø350	665-ZUWA620350	66€	Ø350	665-ZUWA10630350	74€	Ø350	665-ZUWA420350	37.43€	Ø350	665-ZUWA9360350	95€	Ø350	665-ZUWA3070350	77€
Ø400	665-ZUWA620400	74€	Ø400	665-ZUWA10630400	84€	Ø400	665-ZUWA420400	40.87€	Ø400	665-ZUWA9360400	104€	Ø400	665-ZUWA3070400	83€
Ø450	665-ZUWA620450	83€	Ø450	665-ZUWA10630450	97€	Ø450	665-ZUWA420450	56€	Ø450	665-ZUWA9360450	144€	Ø450	665-ZUWA3070450	114€
Ø500	665-ZUWA620500	96€	Ø500	665-ZUWA10630500	106€	Ø500	665-ZUWA420500	74€	Ø500	665-ZUWA9360500	186€	Ø500	665-ZUWA3070500	151€
Ø550	665-ZUWA620550	103€	Ø550	665-ZUWA10630550	114€	Ø550	665-ZUWA420550	98€	Ø550	665-ZUWA9360550	241€	Ø550	665-ZUWA3070550	199€
Ø600	665-ZUWA620600	109€	Ø600	665-ZUWA10630600	129€	Ø600	665-ZUWA420600	106€	Ø600	665-ZUWA9360600	264€	Ø600	665-ZUWA3070600	211€
Ø650	665-ZUWA620650	115€	Ø650	665-ZUWA10630650	139€	Ø650	665-ZUWA420650	114€	Ø650	665-ZUWA9360650	286€	Ø650	665-ZUWA3070650	234€
Ø700	665-ZUWA620700	122€	Ø700	665-ZUWA10630700	151€	Ø700	665-ZUWA420700	151€	Ø700	665-ZUWA9360700	329€	Ø700	665-ZUWA3070700	268€
Ø750	665-ZUWA620750	130€	Ø750	665-ZUWA10630750	168€	Ø750	665-ZUWA420750	185€	Ø750	665-ZUWA9360750	367€	Ø750	665-ZUWA3070750	296€
Ø800	665-ZUWA620800	136€	Ø800	665-ZUWA10630800	179€	Ø800	665-ZUWA420800	204€	Ø800	665-ZUWA9360800	421€	Ø800	665-ZUWA3070800	343€



# CHIMENEA INDIVIDUAL

## Sistema EW - ECO 316

**i** Precio unidad. u/c= unidad caja.

**i** Necesario instalar collarin con el cubreaguas.

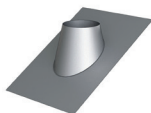
**i**

Cubreaguas 25°-45°  
aluminio

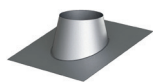
**i**

Cubreaguas 5°-25°  
aluminio

**i**

Cubreaguas plano inox

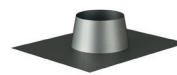
**i**

Cubreaguas plomo 0°-5°

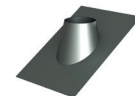
**i**

Cubreaguas plomo 25°-45°

Ø80	665-ZUWA939AL0080	187€	Ø80	665-ZUWA938AL0080	184€	Ø80	665-ZUWA11280080	144€	Ø80	665-ZUWA9370080	203€	Ø80	665-ZUWA9390080	348€
Ø100	665-ZUWA939AL0100	202€	Ø100	665-ZUWA938AL0100	191€	Ø100	665-ZUWA11280100	145€	Ø100	665-ZUWA9370100	204€	Ø100	665-ZUWA9390100	356€
Ø130	665-ZUWA939AL0130	219€	Ø130	665-ZUWA938AL0130	206€	Ø130	665-ZUWA11280130	146€	Ø130	665-ZUWA9370130	205€	Ø130	665-ZUWA9390130	358€
Ø150	665-ZUWA939AL0150	233€	Ø150	665-ZUWA938AL0150	215€	Ø150	665-ZUWA11280150	150€	Ø150	665-ZUWA9370150	206€	Ø150	665-ZUWA9390150	363€
Ø180	665-ZUWA939AL0180	250€	Ø180	665-ZUWA938AL0180	235€	Ø180	665-ZUWA11280180	170€	Ø180	665-ZUWA9370180	234€	Ø180	665-ZUWA9390180	379€
Ø200	665-ZUWA939AL0200	269€	Ø200	665-ZUWA938AL0200	252€	Ø200	665-ZUWA11280200	185€	Ø200	665-ZUWA9370200	260€	Ø200	665-ZUWA9390200	386€
Ø250	665-ZUWA939AL0250	305€	Ø250	665-ZUWA938AL0250	282€	Ø250	665-ZUWA11280250	211€	Ø250	665-ZUWA9370250	294€	Ø250	665-ZUWA9390250	401€
Ø300	665-ZUWA939AL0300	332€	Ø300	665-ZUWA938AL0300	317€	Ø300	665-ZUWA11280300	233€	Ø300	665-ZUWA9370300	323€	Ø300	665-ZUWA9390300	417€
Ø350	665-ZUWA939AL0350	387€	Ø350	665-ZUWA938AL0350	351€	Ø350	665-ZUWA11280350	260€	Ø350	665-ZUWA9370350	361€	Ø350	665-ZUWA9390350	431€
Ø400	665-ZUWA939AL0400	433€	Ø400	665-ZUWA938AL0400	390€	Ø400	665-ZUWA11280400	286€	Ø400	665-ZUWA9370400	396€	Ø400	665-ZUWA9390400	454€
Ø450	665-ZUWA939AL0450	492€	Ø450	665-ZUWA938AL0450	436€	Ø450	665-ZUWA11280450	306€	Ø450	665-ZUWA9370450	428€	Ø450	665-ZUWA9390450	541€
Ø500	665-ZUWA939AL0500	549€	Ø500	665-ZUWA938AL0500	488€	Ø500	665-ZUWA11280500	352€	Ø500	665-ZUWA9370500	488€	Ø500	665-ZUWA9390500	618€
Ø550	665-ZUWA939AL0550	607€	Ø550	665-ZUWA938AL0550	524€	Ø550	665-ZUWA11280550	389€	Ø550	665-ZUWA9370550	539€	Ø550	665-ZUWA9390550	691€
Ø600	665-ZUWA939AL0600	661€	Ø600	665-ZUWA938AL0600	573€	Ø600	665-ZUWA11280600	437€	Ø600	665-ZUWA9370600	606€	Ø600	665-ZUWA9390600	775€
Ø650	665-ZUWA939AL0650	730€	Ø650	665-ZUWA938AL0650	618€	Ø650	665-ZUWA11280650	492€	Ø650	665-ZUWA9370650	684€	Ø650	665-ZUWA9390650	869€
Ø700	665-ZUWA939AL0700	840€	Ø700	665-ZUWA938AL0700	679€	Ø700	665-ZUWA11280700	551€	Ø700	665-ZUWA9370700	763€	Ø700	665-ZUWA9390700	971€
Ø750	665-ZUWA939AL0750	939€	Ø750	665-ZUWA938AL0750	736€	Ø750	665-ZUWA11280750	587€	Ø750	665-ZUWA9370750	815€	Ø750	665-ZUWA9390750	1034€
Ø800	665-ZUWA939AL0800	1123€	Ø800	665-ZUWA938AL0800	880€	Ø800	665-ZUWA11280800	614€	Ø800	665-ZUWA9370800	850€	Ø800	665-ZUWA9390800	1082€

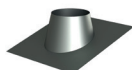
**i**

Cubreaguas plomo 5°-25°



Pasamuros

**i**

Junta de silicona  
(T<200°C)

Ø80	665-ZUWA9380080	203€	Ø80	665-ZUWA9870080	30.9€	Ø80	665-ZUWA260080	4.88€
Ø100	665-ZUWA9380100	204€	Ø100	665-ZUWA9870100	37.43€	Ø100	665-ZUWA260100	4.88€
Ø130	665-ZUWA9380130	205€	Ø130	665-ZUWA9870130	39.04€	Ø130	665-ZUWA260130	4.88€
Ø150	665-ZUWA9380150	206€	Ø150	665-ZUWA9870150	40.87€	Ø150	665-ZUWA260150	4.88€
Ø180	665-ZUWA9380180	234€	Ø180	665-ZUWA9870180	52€	Ø180	665-ZUWA260180	6.52€
Ø200	665-ZUWA9380200	260€	Ø200	665-ZUWA9870200	52€	Ø200	665-ZUWA260200	8.15€
Ø250	665-ZUWA9380250	294€	Ø250	665-ZUWA9870250	65€	Ø250	665-ZUWA260250	11.38€
Ø300	665-ZUWA9380300	323€	Ø300	665-ZUWA9870300	83€	Ø300	665-ZUWA260300	14.65€
Ø350	665-ZUWA9380350	361€	Ø350	665-ZUWA9870350	95€	Ø350	665-ZUWA260350	17.9€
Ø400	665-ZUWA9380400	396€	Ø400	665-ZUWA9870400	121€	Ø400	665-ZUWA260400	19.51€
Ø450	665-ZUWA9380450	428€	Ø450	665-ZUWA9870450	156€	Ø450	665-ZUWA260450	21.16€
Ø500	665-ZUWA9380500	488€	Ø500	665-ZUWA9870500	204€	Ø500	665-ZUWA260500	24.4€
Ø550	665-ZUWA9380550	539€	Ø550	665-ZUWA9870550	221€	Ø550	665-ZUWA260550	27.67€
Ø600	665-ZUWA9380600	606€	Ø600	665-ZUWA9870600	244€	Ø600	665-ZUWA260600	30.9€
Ø650	665-ZUWA9380650	684€	Ø650	665-ZUWA9870650	271€	Ø650	665-ZUWA260650	35.77€
Ø700	665-ZUWA9380700	763€	Ø700	665-ZUWA9870700	337€	Ø700	665-ZUWA260700	40.87€
Ø750	665-ZUWA9380750	815€	Ø750	665-ZUWA9870750	398€	Ø750	665-ZUWA260750	45.58€
Ø800	665-ZUWA9380800	850€	Ø800	665-ZUWA9870800	466€	Ø800	665-ZUWA260800	48.72€

## ADAPTADOR CALDERA HEMBRA

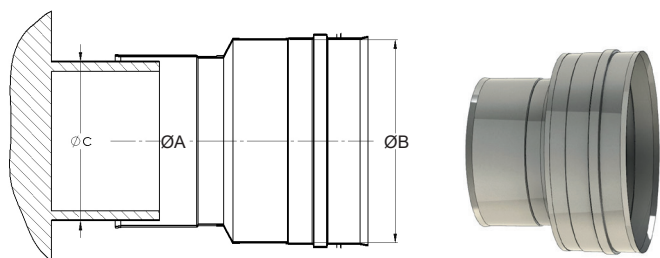

CÓDIGO	Ø A	Ø B	€
671-EWEC37H00800080	Ø80	Ø80	27.67€
671-EWEC37H00800100	Ø80	Ø100	66€
671-EWEC37H00800130	Ø80	Ø130	67€
671-EWEC37H01000080	Ø100	Ø80	67€
671-EWEC37H01000100	Ø100	Ø100	29.27€
671-EWEC37H01000130	Ø100	Ø130	71€
671-EWEC37H01000150	Ø100	Ø150	81€
671-EWEC37H01100080	Ø110	Ø80	67€
671-EWEC37H01100100	Ø110	Ø100	71€
671-EWEC37H01100130	Ø110	Ø130	71€
671-EWEC37H01100150	Ø110	Ø150	81€
671-EWEC37H01200080	Ø120	Ø80	71€
671-EWEC37H01200100	Ø120	Ø100	71€
671-EWEC37H01200130	Ø120	Ø130	71€
671-EWEC37H01200150	Ø120	Ø150	81€
671-EWEC37H01250080	Ø125	Ø80	71€
671-EWEC37H01250100	Ø125	Ø100	71€
671-EWEC37H01250130	Ø125	Ø130	32.52€
671-EWEC37H01250150	Ø125	Ø150	81€
671-EWEC37H01300080	Ø130	Ø80	71€
671-EWEC37H01300100	Ø130	Ø100	71€
671-EWEC37H01300130	Ø130	Ø130	32.52€
671-EWEC37H01300150	Ø130	Ø150	83€
671-EWEC37H01300180	Ø130	Ø180	98€
671-EWEC37H01350080	Ø135	Ø80	65€
671-EWEC37H01350100	Ø135	Ø100	84€
671-EWEC37H01350130	Ø135	Ø130	32.52€
671-EWEC37H01350150	Ø135	Ø150	83€
671-EWEC37H01350180	Ø135	Ø180	98€
671-EWEC37H01400080	Ø140	Ø80	106€
671-EWEC37H01400100	Ø140	Ø100	84€
671-EWEC37H01400130	Ø140	Ø130	87€
671-EWEC37H01400150	Ø140	Ø150	39.04€
671-EWEC37H01400180	Ø140	Ø180	98€
671-EWEC37H01500080	Ø150	Ø80	107€
671-EWEC37H01500100	Ø150	Ø100	84€
671-EWEC37H01500130	Ø150	Ø130	87€
671-EWEC37H01500150	Ø150	Ø150	39.04€
671-EWEC37H01500180	Ø150	Ø180	98€
671-EWEC37H01500200	Ø150	Ø200	111€
671-EWEC37H01600080	Ø160	Ø80	177€
671-EWEC37H01600100	Ø160	Ø100	100€
671-EWEC37H01600130	Ø160	Ø130	101€
671-EWEC37H01600150	Ø160	Ø150	39.04€
671-EWEC37H01600180	Ø160	Ø180	98€
671-EWEC37H01600200	Ø160	Ø200	111€
671-EWEC37H01750080	Ø175	Ø80	177€
671-EWEC37H01750130	Ø175	Ø130	101€
671-EWEC37H01750150	Ø175	Ø150	99€
671-EWEC37H01750180	Ø175	Ø180	45.58€
671-EWEC37H01750200	Ø175	Ø200	111€

671-EWEC37H01800080	Ø180	Ø80	177€
671-EWEC37H01800100	Ø180	Ø100	100€
671-EWEC37H01800130	Ø180	Ø130	101€
671-EWEC37H01800150	Ø180	Ø150	99€
671-EWEC37H01800180	Ø180	Ø180	45.58€
671-EWEC37H01800200	Ø180	Ø200	112€
671-EWEC37H01800250	Ø180	Ø250	123€
671-EWEC37H02000150	Ø200	Ø150	112€
671-EWEC37H02000180	Ø200	Ø180	112€
671-EWEC37H02000200	Ø200	Ø200	52€
671-EWEC37H02000250	Ø200	Ø250	127€
671-EWEC37H02000300	Ø200	Ø300	168€
671-EWEC37H02250180	Ø225	Ø180	121€
671-EWEC37H02250200	Ø225	Ø200	122€
671-EWEC37H02250250	Ø225	Ø250	127€
671-EWEC37H02250300	Ø225	Ø300	168€
671-EWEC37H02500180	Ø250	Ø180	121€
671-EWEC37H02500200	Ø250	Ø200	122€
671-EWEC37H02500250	Ø250	Ø250	66€
671-EWEC37H02500300	Ø250	Ø300	170€
671-EWEC37H02500350	Ø250	Ø350	169€
671-EWEC37H03000200	Ø300	Ø200	160€
671-EWEC37H03000250	Ø300	Ø250	168€
671-EWEC37H03000300	Ø300	Ø300	80€
671-EWEC37H03000350	Ø300	Ø350	172€
671-EWEC37H03000400	Ø300	Ø400	196€
671-EWEC37H03500250	Ø350	Ø250	191€
671-EWEC37H03500300	Ø350	Ø300	202€
671-EWEC37H03500350	Ø350	Ø350	87€
671-EWEC37H03500400	Ø350	Ø400	205€
671-EWEC37H03500450	Ø350	Ø450	322€
671-EWEC37H04000300	Ø400	Ø300	222€
671-EWEC37H04000350	Ø400	Ø350	204€
671-EWEC37H04000400	Ø400	Ø400	96€
671-EWEC37H04000450	Ø400	Ø450	327€
671-EWEC37H04000500	Ø400	Ø500	436€
671-EWEC37H04500350	Ø450	Ø350	271€
671-EWEC37H04500400	Ø450	Ø400	278€
671-EWEC37H04500450	Ø450	Ø450	132€
671-EWEC37H04500500	Ø450	Ø500	447€
671-EWEC37H04500550	Ø450	Ø550	792€
671-EWEC37H05000400	Ø500	Ø400	283€
671-EWEC37H05000450	Ø500	Ø450	337€
671-EWEC37H05000500	Ø500	Ø500	185€
671-EWEC37H05000550	Ø500	Ø550	802€
671-EWEC37H05000600	Ø500	Ø600	837€
671-EWEC37H05500450	Ø550	Ø450	486€
671-EWEC37H05500500	Ø550	Ø500	648€
671-EWEC37H05500550	Ø550	Ø550	260€
671-EWEC37H05500600	Ø550	Ø600	846€
671-EWEC37H05500650	Ø550	Ø650	905€
671-EWEC37H06000500	Ø600	Ø500	668€
671-EWEC37H06000550	Ø600	Ø550	845€
671-EWEC37H06000600	Ø600	Ø600	304€
671-EWEC37H06000650	Ø600	Ø650	917€
671-EWEC37H06000700	Ø600	Ø700	971€
671-EWEC37H06500650	Ø650	Ø650	330€
671-EWEC37H06500700	Ø650	Ø700	987€
671-EWEC37H06500750	Ø650	Ø750	1041€
671-EWEC37H07000700	Ø700	Ø700	358€
671-EWEC37H07000750	Ø700	Ø750	1058€
671-EWEC37H07000800	Ø700	Ø800	1114€
671-EWEC37H07500750	Ø750	Ø750	384€
671-EWEC37H07500800	Ø750	Ø800	1129€
671-EWEC37H08000800	Ø800	Ø800	411€



# CHIMENEA INDIVIDUAL

## Sistema EW - ECO 316

### ADAPTADOR CALDERA MACHO

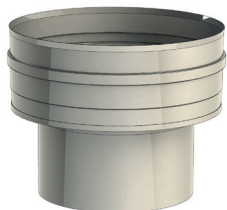
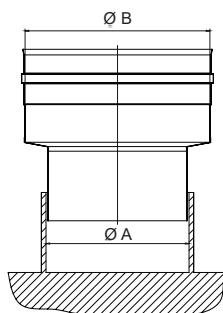

CÓDIGO	Ø A	Ø B	€
671-EWEC37M008000080	Ø80	Ø80	27.67€
671-EWEC37M008000100	Ø80	Ø100	66€
671-EWEC37M008000130	Ø80	Ø130	67€
671-EWEC37M010000080	Ø100	Ø80	67€
671-EWEC37M010000100	Ø100	Ø100	29.27€
671-EWEC37M010000130	Ø100	Ø130	71€
671-EWEC37M010000150	Ø100	Ø150	81€
671-EWEC37M011000080	Ø110	Ø80	67€
671-EWEC37M011000100	Ø110	Ø100	71€
671-EWEC37M011000130	Ø110	Ø130	71€
671-EWEC37M011000150	Ø110	Ø150	81€
671-EWEC37M012000080	Ø120	Ø80	71€
671-EWEC37M012000100	Ø120	Ø100	71€
671-EWEC37M012000130	Ø120	Ø130	71€
671-EWEC37M012000150	Ø120	Ø150	81€
671-EWEC37M012500080	Ø125	Ø80	71€
671-EWEC37M012500100	Ø125	Ø100	71€
671-EWEC37M012500130	Ø125	Ø130	32.52€
671-EWEC37M012500150	Ø125	Ø150	81€
671-EWEC37M013000080	Ø130	Ø80	71€
671-EWEC37M013000100	Ø130	Ø100	71€
671-EWEC37M013000130	Ø130	Ø130	32.52€
671-EWEC37M013000150	Ø130	Ø150	83€
671-EWEC37M013000180	Ø130	Ø180	98€
671-EWEC37M013500100	Ø135	Ø100	84€
671-EWEC37M013500130	Ø135	Ø130	32.52€
671-EWEC37M013500150	Ø135	Ø150	83€
671-EWEC37M013500180	Ø135	Ø180	98€
671-EWEC37M014000100	Ø140	Ø100	84€
671-EWEC37M014000130	Ø140	Ø130	87€
671-EWEC37M014000150	Ø140	Ø150	39.04€
671-EWEC37M014000180	Ø140	Ø180	98€
671-EWEC37M015000100	Ø150	Ø100	84€
671-EWEC37M015000130	Ø150	Ø130	87€
671-EWEC37M015000150	Ø150	Ø150	39.04€
671-EWEC37M015000180	Ø150	Ø180	98€
671-EWEC37M015000200	Ø150	Ø200	111€
671-EWEC37M016000130	Ø160	Ø130	101€
671-EWEC37M016000150	Ø160	Ø150	39.04€
671-EWEC37M016000180	Ø160	Ø180	98€
671-EWEC37M016000200	Ø160	Ø200	111€
671-EWEC37M017500130	Ø175	Ø130	101€
671-EWEC37M017500150	Ø175	Ø150	99€
671-EWEC37M017500180	Ø175	Ø180	45.58€
671-EWEC37M017500200	Ø175	Ø200	111€
671-EWEC37M018000130	Ø180	Ø130	101€
671-EWEC37M018000150	Ø180	Ø150	99€
671-EWEC37M018000180	Ø180	Ø180	45.58€
671-EWEC37M018000200	Ø180	Ø200	112€
671-EWEC37M018000250	Ø180	Ø250	123€
671-EWEC37M020000150	Ø200	Ø150	112€

671-EWEC37M020000180	Ø200	Ø180	112€
671-EWEC37M020000200	Ø200	Ø200	52€
671-EWEC37M020000250	Ø200	Ø250	127€
671-EWEC37M020000300	Ø200	Ø300	168€
671-EWEC37M022500180	Ø225	Ø180	121€
671-EWEC37M022500200	Ø225	Ø200	122€
671-EWEC37M022500250	Ø225	Ø250	127€
671-EWEC37M022500300	Ø225	Ø300	168€
671-EWEC37M025000180	Ø250	Ø180	121€
671-EWEC37M025000200	Ø250	Ø200	122€
671-EWEC37M025000250	Ø250	Ø250	66€
671-EWEC37M025000300	Ø250	Ø300	170€
671-EWEC37M025000350	Ø250	Ø350	169€
671-EWEC37M030000250	Ø300	Ø250	168€
671-EWEC37M030000300	Ø300	Ø300	80€
671-EWEC37M030000350	Ø300	Ø350	172€
671-EWEC37M030000400	Ø300	Ø400	196€
671-EWEC37M035000250	Ø350	Ø250	191€
671-EWEC37M035000300	Ø350	Ø300	202€
671-EWEC37M035000350	Ø350	Ø350	87€
671-EWEC37M035000400	Ø350	Ø400	205€
671-EWEC37M035000450	Ø350	Ø450	322€
671-EWEC37M040000300	Ø400	Ø300	222€
671-EWEC37M040000350	Ø400	Ø350	204€
671-EWEC37M040000400	Ø400	Ø400	96€
671-EWEC37M040000450	Ø400	Ø450	327€
671-EWEC37M040000500	Ø400	Ø500	436€
671-EWEC37M045000350	Ø450	Ø350	271€
671-EWEC37M045000400	Ø450	Ø400	278€
671-EWEC37M045000450	Ø450	Ø450	132€
671-EWEC37M045000500	Ø450	Ø500	447€
671-EWEC37M045000550	Ø450	Ø550	792€
671-EWEC37M050000400	Ø500	Ø400	283€
671-EWEC37M050000450	Ø500	Ø450	337€
671-EWEC37M050000500	Ø500	Ø500	185€
671-EWEC37M050000550	Ø500	Ø550	802€
671-EWEC37M050000600	Ø500	Ø600	837€
671-EWEC37M055000450	Ø550	Ø450	486€
671-EWEC37M055000500	Ø550	Ø500	648€
671-EWEC37M055000550	Ø550	Ø550	260€
671-EWEC37M055000600	Ø550	Ø600	846€
671-EWEC37M055000650	Ø550	Ø650	905€
671-EWEC37M060000500	Ø600	Ø500	668€
671-EWEC37M060000550	Ø600	Ø550	845€
671-EWEC37M060000600	Ø600	Ø600	304€
671-EWEC37M060000650	Ø600	Ø650	917€
671-EWEC37M060000700	Ø600	Ø700	971€
671-EWEC37M065000650	Ø650	Ø650	330€
671-EWEC37M065000700	Ø650	Ø700	987€
671-EWEC37M065000750	Ø650	Ø750	1041€
671-EWEC37M070000700	Ø700	Ø700	358€
671-EWEC37M070000750	Ø700	Ø750	1058€
671-EWEC37M070000800	Ø700	Ø800	1114€
671-EWEC37M075000750	Ø750	Ø750	384€
671-EWEC37M075000800	Ø750	Ø800	1129€
671-EWEC37M080000800	Ø800	Ø800	411€

## AMPLIACIONES

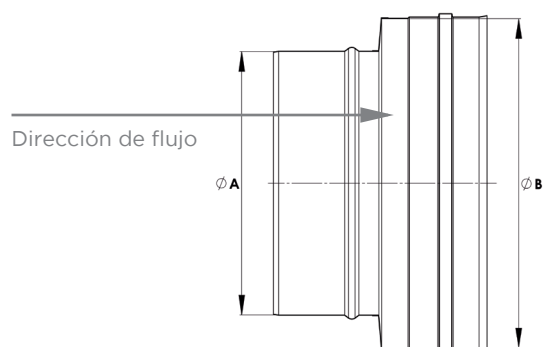

CÓDIGO	Ø A	Ø B	€
671-EWECA00800100	Ø80	Ø100	80€
671-EWECA00800130	Ø80	Ø130	98€
671-EWECA00800150	Ø80	Ø150	111€
671-EWECA00800180	Ø80	Ø180	132€
671-EWECA01000130	Ø100	Ø130	96€
671-EWECA01000150	Ø100	Ø150	109€
671-EWECA01000180	Ø100	Ø180	127€
671-EWECA01000200	Ø100	Ø200	169€
671-EWECA01250130	Ø125	Ø130	84€
671-EWECA01250150	Ø125	Ø150	101€
671-EWECA01250180	Ø125	Ø180	121€
671-EWECA01250200	Ø125	Ø200	161€
671-EWECA01250250	Ø125	Ø250	200€
671-EWECA01300150	Ø130	Ø150	96€
671-EWECA01300180	Ø130	Ø180	117€
671-EWECA01300200	Ø130	Ø200	156€
671-EWECA01300250	Ø130	Ø250	190€
671-EWECA01300300	Ø130	Ø300	256€
671-EWECA01500180	Ø150	Ø180	106€
671-EWECA01500200	Ø150	Ø200	150€
671-EWECA01500250	Ø150	Ø250	184€
671-EWECA01500300	Ø150	Ø300	247€
671-EWECA01500350	Ø150	Ø350	290€
671-EWECA01800200	Ø180	Ø200	137€
671-EWECA01800250	Ø180	Ø250	177€
671-EWECA01800300	Ø180	Ø300	239€
671-EWECA01800350	Ø180	Ø350	278€
671-EWECA01800400	Ø180	Ø400	306€
671-EWECA02000250	Ø200	Ø250	160€
671-EWECA02000300	Ø200	Ø300	226€
671-EWECA02000350	Ø200	Ø350	268€
671-EWECA02000400	Ø200	Ø400	296€
671-EWECA02000450	Ø200	Ø450	334€
671-EWECA02500300	Ø250	Ø300	206€
671-EWECA02500350	Ø250	Ø350	252€
671-EWECA02500400	Ø250	Ø400	286€
671-EWECA02500450	Ø250	Ø450	322€
671-EWECA02500500	Ø250	Ø500	363€
671-EWECA03000350	Ø300	Ø350	234€

671-EWECA03000400	Ø300	Ø400	271€
671-EWECA03000450	Ø300	Ø450	305€
671-EWECA03000500	Ø300	Ø500	344€
671-EWECA03000550	Ø300	Ø550	370€
671-EWECA03500400	Ø350	Ø400	247€
671-EWECA03500450	Ø350	Ø450	295€
671-EWECA03500500	Ø350	Ø500	330€
671-EWECA03500550	Ø350	Ø550	361€
671-EWECA03500600	Ø350	Ø600	411€
671-EWECA04000450	Ø400	Ø450	268€
671-EWECA04000500	Ø400	Ø500	317€
671-EWECA04000550	Ø400	Ø550	343€
671-EWECA04000600	Ø400	Ø600	391€
671-EWECA04000650	Ø400	Ø650	436€
671-EWECA04500500	Ø450	Ø500	289€
671-EWECA04500550	Ø450	Ø550	329€
671-EWECA04500600	Ø450	Ø600	375€
671-EWECA04500650	Ø450	Ø650	416€
671-EWECA04500700	Ø450	Ø700	540€
671-EWECA05000550	Ø500	Ø550	298€
671-EWECA05000600	Ø500	Ø600	363€
671-EWECA05000650	Ø500	Ø650	400€
671-EWECA05000700	Ø500	Ø700	517€
671-EWECA05000750	Ø500	Ø750	567€
671-EWECA05500600	Ø550	Ø600	328€
671-EWECA05500650	Ø550	Ø650	384€
671-EWECA05500700	Ø550	Ø700	500€
671-EWECA05500750	Ø550	Ø750	541€
671-EWECA05500800	Ø550	Ø800	617€
671-EWECA06000650	Ø600	Ø650	348€
671-EWECA06000700	Ø600	Ø700	473€
671-EWECA06000750	Ø600	Ø750	520€
671-EWECA06000800	Ø600	Ø800	592€
671-EWECA06500700	Ø650	Ø700	430€
671-EWECA06500750	Ø650	Ø750	500€
671-EWECA06500800	Ø650	Ø800	568€
671-EWECA07000750	Ø700	Ø750	453€
671-EWECA07000800	Ø700	Ø800	541€
671-EWECA07500800	Ø750	Ø800	496€



# CHIMENEA INDIVIDUAL

## Sistema EW - ECO 316

### REDUCCIONES

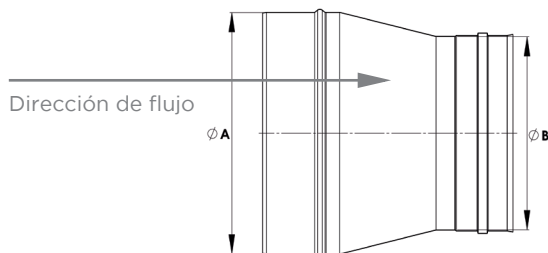

CÓDIGO	Ø A	Ø B	€
671-EWECR01000080	Ø100	Ø80	80€
671-EWECR01250080	Ø125	Ø80	96€
671-EWECR01250100	Ø125	Ø100	84€
671-EWECR01300080	Ø130	Ø80	98€
671-EWECR01300100	Ø130	Ø100	96€
671-EWECR01500080	Ø150	Ø80	111€
671-EWECR01500100	Ø150	Ø100	109€
671-EWECR01500130	Ø150	Ø130	96€
671-EWECR01800080	Ø180	Ø80	132€
671-EWECR01800100	Ø180	Ø100	127€
671-EWECR01800130	Ø180	Ø130	117€
671-EWECR01800150	Ø180	Ø150	106€
671-EWECR02000100	Ø200	Ø100	169€
671-EWECR02000130	Ø200	Ø130	156€
671-EWECR02000150	Ø200	Ø150	150€
671-EWECR02000180	Ø200	Ø180	137€
671-EWECR02500130	Ø250	Ø130	190€
671-EWECR02500150	Ø250	Ø150	184€
671-EWECR02500180	Ø250	Ø180	177€
671-EWECR02500200	Ø250	Ø200	160€
671-EWECR03000130	Ø300	Ø130	256€
671-EWECR03000150	Ø300	Ø150	247€
671-EWECR03000180	Ø300	Ø180	239€
671-EWECR03000200	Ø300	Ø200	226€
671-EWECR03000250	Ø300	Ø250	206€
671-EWECR03500150	Ø350	Ø150	290€
671-EWECR03500180	Ø350	Ø180	278€
671-EWECR03500200	Ø350	Ø200	268€
671-EWECR03500250	Ø350	Ø250	252€
671-EWECR03500300	Ø350	Ø300	234€
671-EWECR04000180	Ø400	Ø180	306€
671-EWECR04000200	Ø400	Ø200	296€
671-EWECR04000250	Ø400	Ø250	286€
671-EWECR04000300	Ø400	Ø300	271€
671-EWECR04000350	Ø400	Ø350	247€
671-EWECR04500200	Ø450	Ø200	334€
671-EWECR04500250	Ø450	Ø250	322€

671-EWECR04500300	Ø450	Ø300	305€
671-EWECR04500350	Ø450	Ø350	295€
671-EWECR04500400	Ø450	Ø400	268€
671-EWECR05000250	Ø500	Ø250	363€
671-EWECR05000300	Ø500	Ø300	344€
671-EWECR05000350	Ø500	Ø350	330€
671-EWECR05000400	Ø500	Ø400	317€
671-EWECR05000450	Ø500	Ø450	289€
671-EWECR05500300	Ø550	Ø300	370€
671-EWECR05500350	Ø550	Ø350	361€
671-EWECR05500400	Ø550	Ø400	343€
671-EWECR05500450	Ø550	Ø450	329€
671-EWECR05500500	Ø550	Ø500	298€
671-EWECR06000350	Ø600	Ø350	411€
671-EWECR06000400	Ø600	Ø400	391€
671-EWECR06000450	Ø600	Ø450	375€
671-EWECR06000500	Ø600	Ø500	363€
671-EWECR06000550	Ø600	Ø550	328€
671-EWECR06500400	Ø650	Ø400	436€
671-EWECR06500450	Ø650	Ø450	416€
671-EWECR06500500	Ø650	Ø500	400€
671-EWECR06500550	Ø650	Ø550	384€
671-EWECR06500600	Ø650	Ø600	348€
671-EWECR07000450	Ø700	Ø450	540€
671-EWECR07000500	Ø700	Ø500	517€
671-EWECR07000550	Ø700	Ø550	500€
671-EWECR07000600	Ø700	Ø600	473€
671-EWECR07000650	Ø700	Ø650	430€
671-EWECR07500500	Ø750	Ø500	567€
671-EWECR07500550	Ø750	Ø550	541€
671-EWECR07500600	Ø750	Ø600	520€
671-EWECR07500650	Ø750	Ø650	500€
671-EWECR07500700	Ø750	Ø700	453€
671-EWECR08000550	Ø800	Ø550	617€
671-EWECR08000600	Ø800	Ø600	592€
671-EWECR08000650	Ø800	Ø650	568€
671-EWECR08000700	Ø800	Ø700	541€
671-EWECR08000750	Ø800	Ø750	496€



# CHIMENEA INDIVIDUAL

Sistema **EW - ECO 304**

Chimenea modular metálica para evacuación de humos y gases de los productos de la combustión de simple pared fabricada en acero inoxidable.

## MATERIAL

AISI 304

## ACABADO EXTERIOR

Brillante

Colores RAL sólo hasta 200°C (según diámetro, consultar precios)

## ESPEORES (mm)

0,4 - 0,5 - 0,6 - 0,8 (según el diámetro)

## DIÁMETROS DISPONIBLES (mm)

Ø80 a Ø800

## SISTEMA DE UNIÓN

Conexión macho-hembra con **abrazadera de unión sencilla**



## APLICACIONES

- Calderas de gas y gasoil
- No condensación



## CARACTERÍSTICAS

- Instalación por patinillo interior
- Temperatura de trabajo hasta 600°C
- **Soldadura TIG/LÁSER** en continuo en todas las piezas
- Abrazadera de unión **NO INCLUIDA**
- Posibilidad de **corte de módulos rectos a medida en obra**

## CERTIFICADO CE

0036 CPR 9174 029

## CLASIFICACIONES CE (UNE-EN 1856-1)

T600 - N1 - D - Vm - L20040 - G(100)

T400 - N1 - W - Vm - L20040 - O(50)

T200 - P1 - W - Vm - L20040 - O(00) (con junta de estanqueidad T<200°C).



# CHIMENEA INDIVIDUAL

## Sistema EW - ECO 304



Módulo recto 1000mm



Módulo recto 500mm



Módulo recto 250mm



Módulo recto 250mm con  
desagüe lateral



Módulo recto regulable  
400-560mm

Ø80	670-EWEC130080	42.42€	Ø80	670-EWEC140080	27.67€	Ø80	670-EWEC150080	14.65€	Ø80	670-EWEC15D0080	27.67€	Ø80	670-EWEC5440080	52€
Ø100	670-EWEC130100	45.58€	Ø100	670-EWEC140100	29.27€	Ø100	670-EWEC150100	17.9€	Ø100	670-EWEC15D0100	29.27€	Ø100	670-EWEC5440100	61€
Ø130	670-EWEC130130	48.72€	Ø130	670-EWEC140130	30.9€	Ø130	670-EWEC150130	17.9€	Ø130	670-EWEC15D0130	29.27€	Ø130	670-EWEC5440130	67€
Ø150	670-EWEC130150	56€	Ø150	670-EWEC140150	32.52€	Ø150	670-EWEC150150	17.9€	Ø150	670-EWEC15D0150	35.77€	Ø150	670-EWEC5440150	83€
Ø180	670-EWEC130180	66€	Ø180	670-EWEC140180	39.04€	Ø180	670-EWEC150180	22.77€	Ø180	670-EWEC15D0180	37.43€	Ø180	670-EWEC5440180	99€
Ø200	670-EWEC130200	80€	Ø200	670-EWEC140200	45.58€	Ø200	670-EWEC150200	27.67€	Ø200	670-EWEC15D0200	42.42€	Ø200	670-EWEC5440200	101€
Ø250	670-EWEC130250	106€	Ø250	670-EWEC140250	56€	Ø250	670-EWEC150250	32.52€	Ø250	670-EWEC15D0250	47.13€	Ø250	670-EWEC5440250	133€
Ø300	670-EWEC130300	127€	Ø300	670-EWEC140300	66€	Ø300	670-EWEC150300	37.43€	Ø300	670-EWEC15D0300	50€	Ø300	670-EWEC5440300	170€
Ø350	670-EWEC130350	143€	Ø350	670-EWEC140350	84€	Ø350	670-EWEC150350	50€	Ø350	670-EWEC15D0350	66€	Ø350	670-EWEC5440350	190€
Ø400	670-EWEC130400	156€	Ø400	670-EWEC140400	96€	Ø400	670-EWEC150400	58€	Ø400	670-EWEC15D0400	78€	Ø400	670-EWEC5440400	207€
Ø450	670-EWEC130450	183€	Ø450	670-EWEC140450	127€	Ø450	670-EWEC150450	84€	Ø450	670-EWEC15D0450	101€	Ø450	670-EWEC5440450	267€
Ø500	670-EWEC130500	236€	Ø500	670-EWEC140500	160€	Ø500	670-EWEC150500	109€	Ø500	670-EWEC15D0500	129€	Ø500	670-EWEC5440500	316€
Ø550	670-EWEC130550	321€	Ø550	670-EWEC140550	207€	Ø550	670-EWEC150550	138€	Ø550	670-EWEC15D0550	156€	Ø550	670-EWEC5440550	334€
Ø600	670-EWEC130600	343€	Ø600	670-EWEC140600	227€	Ø600	670-EWEC150600	151€	Ø600	670-EWEC15D0600	169€	Ø600	670-EWEC5440600	384€
Ø650	670-EWEC130650	366€	Ø650	670-EWEC140650	241€	Ø650	670-EWEC150650	160€	Ø650	670-EWEC15D0650	186€	Ø650	670-EWEC5440650	408€
Ø700	670-EWEC130700	454€	Ø700	670-EWEC140700	297€	Ø700	670-EWEC150700	200€	Ø700	670-EWEC15D0700	226€	Ø700	670-EWEC5440700	504€
Ø750	670-EWEC130750	473€	Ø750	670-EWEC140750	312€	Ø750	670-EWEC150750	207€	Ø750	670-EWEC15D0750	236€	Ø750	670-EWEC5440750	527€
Ø800	670-EWEC130800	517€	Ø800	670-EWEC140800	337€	Ø800	670-EWEC150800	227€	Ø800	670-EWEC15D0800	252€	Ø800	670-EWEC5440800	573€



Módulo recto regulable  
560-920mm



Módulo de descenso



Codo 15°



Codo 30°



Codo 45°

Ø80	670-EWEC5450080	67€	Ø80	670-EWEC14680080	66€	Ø80	670-EWEC160080	22.77€	Ø80	670-EWEC170080	22.77€	Ø80	670-EWEC180080	22.77€
Ø100	670-EWEC5450100	74€	Ø100	670-EWEC14680100	74€	Ø100	670-EWEC160100	26.04€	Ø100	670-EWEC170100	26.04€	Ø100	670-EWEC180100	26.04€
Ø130	670-EWEC5450130	81€	Ø130	670-EWEC14680130	80€	Ø130	670-EWEC160130	27.67€	Ø130	670-EWEC170130	27.67€	Ø130	670-EWEC180130	27.67€
Ø150	670-EWEC5450150	99€	Ø150	670-EWEC14680150	91€	Ø150	670-EWEC160150	30.9€	Ø150	670-EWEC170150	30.9€	Ø150	670-EWEC180150	30.9€
Ø180	670-EWEC5450180	109€	Ø180	670-EWEC14680180	106€	Ø180	670-EWEC160180	40.87€	Ø180	670-EWEC170180	40.87€	Ø180	670-EWEC180180	40.87€
Ø200	670-EWEC5450200	122€	Ø200	670-EWEC14680200	129€	Ø200	670-EWEC160200	45.58€	Ø200	670-EWEC170200	45.58€	Ø200	670-EWEC180200	45.58€
Ø250	670-EWEC5450250	141€	Ø250	670-EWEC14680250	170€	Ø250	670-EWEC160250	58€	Ø250	670-EWEC170250	58€	Ø250	670-EWEC180250	58€
Ø300	670-EWEC5450300	178€	Ø300	670-EWEC14680300	200€	Ø300	670-EWEC160300	74€	Ø300	670-EWEC170300	74€	Ø300	670-EWEC180300	74€
Ø350	670-EWEC5450350	241€	Ø350	670-EWEC14680350	233€	Ø350	670-EWEC160350	87€	Ø350	670-EWEC170350	87€	Ø350	670-EWEC180350	87€
Ø400	670-EWEC5450400	268€	Ø400	670-EWEC14680400	249€	Ø400	670-EWEC160400	97€	Ø400	670-EWEC170400	97€	Ø400	670-EWEC180400	97€
Ø450	670-EWEC5450450	334€	Ø450	670-EWEC14680450	290€	Ø450	670-EWEC160450	137€	Ø450	670-EWEC170450	137€	Ø450	670-EWEC180450	137€
Ø500	670-EWEC5450500	356€	Ø500	670-EWEC14680500	379€	Ø500	670-EWEC160500	190€	Ø500	670-EWEC170500	190€	Ø500	670-EWEC180500	190€
Ø550	670-EWEC5450550	391€	Ø550	670-EWEC14680550	508€	Ø550	670-EWEC160550	249€	Ø550	670-EWEC170550	249€	Ø550	670-EWEC180550	249€
Ø600	670-EWEC5450600	430€	Ø600	670-EWEC14680600	552€	Ø600	670-EWEC160600	275€	Ø600	670-EWEC170600	275€	Ø600	670-EWEC180600	275€
Ø650	670-EWEC5450650	457€	Ø650	670-EWEC14680650	586€	Ø650	670-EWEC160650	294€	Ø650	670-EWEC170650	294€	Ø650	670-EWEC180650	294€
Ø700	670-EWEC5450700	568€	Ø700	670-EWEC14680700	724€	Ø700	670-EWEC160700	365€	Ø700	670-EWEC170700	365€	Ø700	670-EWEC180700	365€
Ø750	670-EWEC5450750	595€	Ø750	670-EWEC14680750	757€	Ø750	670-EWEC160750	380€	Ø750	670-EWEC170750	380€	Ø750	670-EWEC180750	380€
Ø800	670-EWEC5450800	649€	Ø800	670-EWEC14680800	828€	Ø800	670-EWEC160800	415€	Ø800	670-EWEC170800	415€	Ø800	670-EWEC180800	415€



Precio unidad. u/c= unidad caja.



Para ángulos diferentes de 90° se produce un cierto desplazamiento del eje.



Codo 60°



Codo 90°



Codo 0°-90°  
Multidireccional



Te 90°



Te 135°

Ø80	670-EWEC840080	27.67€	Ø80	670-EWEC600080	30.9€	Ø80	671-EWEC1010080	73€	Ø80	670-EWEC3170080	48.72€	Ø80	670-EWEC120080	71€
Ø100	670-EWEC840100	29.27€	Ø100	670-EWEC600100	30.9€	Ø100	671-EWEC1010100	73€	Ø100	670-EWEC3170100	56€	Ø100	670-EWEC120100	76€
Ø130	670-EWEC840130	30.9€	Ø130	670-EWEC600130	32.52€	Ø130	671-EWEC1010130	84€	Ø130	670-EWEC3170130	61€	Ø130	670-EWEC120130	80€
Ø150	670-EWEC840150	39.04€	Ø150	670-EWEC600150	44€	Ø150	671-EWEC1010150	100€	Ø150	670-EWEC3170150	74€	Ø150	670-EWEC120150	99€
Ø180	670-EWEC840180	48.72€	Ø180	670-EWEC600180	58€	Ø180	671-EWEC1010180	121€	Ø180	670-EWEC3170180	87€	Ø180	670-EWEC120180	119€
Ø200	670-EWEC840200	54€	Ø200	670-EWEC600200	62€	Ø200	671-EWEC1010200	139€	Ø200	670-EWEC3170200	99€	Ø200	670-EWEC120200	137€
Ø250	670-EWEC840250	71€	Ø250	670-EWEC600250	81€	Ø250	671-EWEC1010250	168€	Ø250	670-EWEC3170250	119€	Ø250	670-EWEC120250	170€
Ø300	670-EWEC840300	91€	Ø300	670-EWEC600300	106€				Ø300	670-EWEC3170300	151€	Ø300	670-EWEC120300	218€
Ø350	670-EWEC840350	106€	Ø350	670-EWEC600350	127€				Ø350	670-EWEC3170350	163€	Ø350	670-EWEC120350	236€
Ø400	670-EWEC840400	122€	Ø400	670-EWEC600400	141€				Ø400	670-EWEC3170400	183€	Ø400	670-EWEC120400	266€
Ø450	670-EWEC840450	150€	Ø450	670-EWEC600450	178€				Ø450	670-EWEC3170450	267€	Ø450	670-EWEC120450	411€
Ø500	670-EWEC840500	190€	Ø500	670-EWEC600500	227€				Ø500	670-EWEC3170500	386€	Ø500	670-EWEC120500	478€
Ø550	670-EWEC840550	239€	Ø550	670-EWEC600550	282€				Ø550	670-EWEC3170550	501€	Ø550	670-EWEC120550	621€
Ø600	670-EWEC840600	283€	Ø600	670-EWEC600600	334€				Ø600	670-EWEC3170600	556€	Ø600	670-EWEC120600	1424€
									Ø650	670-EWEC3170650	591€	Ø650	670-EWEC120650	1513€
									Ø700	670-EWEC3170700	732€	Ø700	670-EWEC120700	1879€
									Ø750	670-EWEC3170750	766€	Ø750	670-EWEC120750	1964€
									Ø800	670-EWEC3170800	838€	Ø800	670-EWEC120800	2142€



Colector de hollín



Colector de hollín con  
desagüe



Codo 90° con tapa de  
inspección P1



Módulo de inspección



Módulo de inspección con  
tapa 200 Pa (P1)

Ø80	670-EWEC5510080	29.27€	Ø80	670-EWEC440080	37.43€	Ø80	670-EWEC19AL0080	96€	Ø80	670-EWEC5430080	35.77€	Ø80	670-EWEC5490080	91€
Ø100	670-EWEC5510100	30.9€	Ø100	670-EWEC440100	40.87€	Ø100	670-EWEC19AL0100	99€	Ø100	670-EWEC5430100	37.43€	Ø100	670-EWEC5490100	100€
Ø130	670-EWEC5510130	30.9€	Ø130	670-EWEC440130	42.42€	Ø130	670-EWEC19AL0130	90€	Ø130	670-EWEC5430130	40.87€	Ø130	670-EWEC5490130	106€
Ø150	670-EWEC5510150	30.9€	Ø150	670-EWEC440150	45.58€	Ø150	670-EWEC19AL0150	121€	Ø150	670-EWEC5430150	48.72€	Ø150	670-EWEC5490150	130€
Ø180	670-EWEC5510180	32.52€	Ø180	670-EWEC440180	48.72€	Ø180	670-EWEC19AL0180	141€	Ø180	670-EWEC5430180	61€	Ø180	670-EWEC5490180	143€
Ø200	670-EWEC5510200	40.87€	Ø200	670-EWEC440200	54€	Ø200	670-EWEC19AL0200	185€	Ø200	670-EWEC5430200	71€	Ø200	670-EWEC5490200	179€
Ø250	670-EWEC5510250	52€	Ø250	670-EWEC440250	67€	Ø250	670-EWEC19AL0250	222€	Ø250	670-EWEC5430250	87€	Ø250	670-EWEC5490250	227€
Ø300	670-EWEC5510300	66€	Ø300	670-EWEC440300	84€	Ø300	670-EWEC19AL0300	245€	Ø300	670-EWEC5430300	101€	Ø300	670-EWEC5490300	260€
Ø350	670-EWEC5510350	87€	Ø350	670-EWEC440350	106€	Ø350	670-EWEC19AL0350	255€	Ø350	670-EWEC5430350	111€	Ø350	670-EWEC5490350	272€
Ø400	670-EWEC5510400	132€	Ø400	670-EWEC440400	178€	Ø400	670-EWEC19AL0400	294€	Ø400	670-EWEC5430400	123€	Ø400	670-EWEC5490400	294€
Ø450	670-EWEC5510450	150€	Ø450	670-EWEC440450	221€	Ø450	670-EWEC19AL0450	427€	Ø450	670-EWEC5430450	172€	Ø450	670-EWEC5490450	380€
Ø500	670-EWEC5510500	161€	Ø500	670-EWEC440500	244€	Ø500	670-EWEC19AL0500	533€	Ø500	670-EWEC5430500	226€	Ø500	670-EWEC5490500	506€
Ø550	670-EWEC5510550	179€	Ø550	670-EWEC440550	268€	Ø550	670-EWEC19AL0550	757€	Ø550	670-EWEC5430550	252€	Ø550	670-EWEC5490550	626€
Ø600	670-EWEC5510600	196€	Ø600	670-EWEC440600	287€	Ø600	670-EWEC19AL0600	891€	Ø600	670-EWEC5430600	268€	Ø600	670-EWEC5490600	685€
Ø650	670-EWEC5510650	206€	Ø650	670-EWEC440650	304€				Ø650	670-EWEC5430650	278€	Ø650	670-EWEC5490650	721€
Ø700	670-EWEC5510700	254€	Ø700	670-EWEC440700	380€				Ø700	670-EWEC5430700	341€	Ø700	670-EWEC5490700	870€
Ø750	670-EWEC5510750	269€	Ø750	670-EWEC440750	393€				Ø750	670-EWEC5430750	365€	Ø750	670-EWEC5490750	905€
Ø800	670-EWEC5510800	294€	Ø800	670-EWEC440800	431€				Ø800	670-EWEC5430800	398€	Ø800	670-EWEC5490800	982€



# CHIMENEA INDIVIDUAL

## Sistema EW - ECO 304



Módulo de inspección con tapa 40 Pa (N1)



Terminal salida libre



Terminal anti-lluvia



Terminal anti-viento

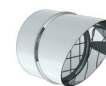

Terminal horizontal con rejilla

Ø80	670-EWEC680080	66€	Ø80	670-EWEC320080	47.13€	Ø80	670-EWEC5260080	66€	Ø80	670-EWEC5270080	96€	Ø80	670-EWEC5320080	52€
Ø100	670-EWEC680100	73€	Ø100	670-EWEC320100	50€	Ø100	670-EWEC5260100	73€	Ø100	670-EWEC5270100	101€	Ø100	670-EWEC5320100	56€
Ø130	670-EWEC680130	80€	Ø130	670-EWEC320130	56€	Ø130	670-EWEC5260130	80€	Ø130	670-EWEC5270130	112€	Ø130	670-EWEC5320130	65€
Ø150	670-EWEC680150	99€	Ø150	670-EWEC320150	73€	Ø150	670-EWEC5260150	99€	Ø150	670-EWEC5270150	141€	Ø150	670-EWEC5320150	81€
Ø180	670-EWEC680180	119€	Ø180	670-EWEC320180	87€	Ø180	670-EWEC5260180	119€	Ø180	670-EWEC5270180	169€	Ø180	670-EWEC5320180	98€
Ø200	670-EWEC680200	137€	Ø200	670-EWEC320200	99€	Ø200	670-EWEC5260200	137€	Ø200	670-EWEC5270200	196€	Ø200	670-EWEC5320200	110€
Ø250	670-EWEC680250	170€	Ø250	670-EWEC320250	123€	Ø250	670-EWEC5260250	170€	Ø250	670-EWEC5270250	247€	Ø250	670-EWEC5320250	139€
Ø300	670-EWEC680300	205€	Ø300	670-EWEC320300	150€	Ø300	670-EWEC5260300	205€	Ø300	670-EWEC5270300	294€	Ø300	670-EWEC5320300	166€
Ø350	670-EWEC680350	222€	Ø350	670-EWEC320350	161€	Ø350	670-EWEC5260350	222€	Ø350	670-EWEC5270350	356€	Ø350	670-EWEC5320350	180€
Ø400	670-EWEC680400	247€	Ø400	670-EWEC320400	180€	Ø400	670-EWEC5260400	247€	Ø400	670-EWEC5270400	391€	Ø400	670-EWEC5320400	204€
Ø450	670-EWEC680450	344€	Ø450	670-EWEC320450	242€							Ø450	670-EWEC5320450	269€
Ø500	670-EWEC680500	450€	Ø500	670-EWEC320500	303€							Ø500	670-EWEC5320500	337€
Ø550	670-EWEC680550	586€	Ø550	670-EWEC320550	391€							Ø550	670-EWEC5320550	439€
Ø600	670-EWEC680600	632€	Ø600	670-EWEC320600	424€							Ø600	670-EWEC5320600	473€
Ø650	670-EWEC680650	667€	Ø650	670-EWEC320650	452€							Ø650	670-EWEC5320650	503€
Ø700	670-EWEC680700	832€	Ø700	670-EWEC320700	557€							Ø700	670-EWEC5320700	622€
Ø750	670-EWEC680750	870€	Ø750	670-EWEC320750	586€							Ø750	670-EWEC5320750	653€
Ø800	670-EWEC680800	950€	Ø800	670-EWEC320800	636€							Ø800	670-EWEC5320800	709€



Terminal Gas



Terminal GAS light



Adaptador a Hurricane

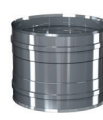

Manguito hembra-hembra



Manguito macho-macho

Ø130	670-EWEC14540130	337€	Ø80	670-EWEC43500080	169€	Ø130	670-EWEC44760130	65€	Ø80	670-EWEC6130080	13.01€	Ø80	670-EWEC9720080	13.01€
Ø150	670-EWEC14540150	375€	Ø100	670-EWEC43500100	180€	Ø150	670-EWEC44760150	71€	Ø100	670-EWEC6130100	19.51€	Ø100	670-EWEC9720100	19.51€
Ø180	670-EWEC14540180	416€	Ø130	670-EWEC43500130	199€	Ø180	670-EWEC44760180	83€	Ø130	670-EWEC6130130	27.67€	Ø130	670-EWEC9720130	27.67€
Ø200	670-EWEC14540200	522€	Ø150	670-EWEC43500150	226€	Ø200	670-EWEC44760200	100€	Ø150	670-EWEC6130150	32.52€	Ø150	670-EWEC9720150	32.52€
Ø250	670-EWEC14540250	637€	Ø180	670-EWEC43500180	247€	Ø250	670-EWEC44760250	117€	Ø180	670-EWEC6130180	37.43€	Ø180	670-EWEC9720180	37.43€
Ø300	670-EWEC14540300	730€	Ø200	670-EWEC43500200	274€	Ø300	670-EWEC44760300	145€	Ø200	670-EWEC6130200	40.87€	Ø200	670-EWEC9720200	40.87€
Ø350	670-EWEC14540350	952€	Ø250	670-EWEC43500250	365€				Ø250	670-EWEC6130250	48.72€	Ø250	670-EWEC9720250	48.72€
Ø400	670-EWEC14540400	1058€	Ø300	670-EWEC43500300	472€				Ø300	670-EWEC6130300	61€	Ø300	670-EWEC9720300	61€
Ø450	670-EWEC14540450	1278€							Ø350	670-EWEC6130350	73€	Ø350	670-EWEC9720350	73€
Ø500	670-EWEC14540500	1610€							Ø400	670-EWEC6130400	80€	Ø400	670-EWEC9720400	80€
Ø550	670-EWEC14540550	1799€							Ø450	670-EWEC6130450	90€	Ø450	670-EWEC9720450	90€
Ø600	670-EWEC14540600	1995€							Ø500	670-EWEC6130500	109€	Ø500	670-EWEC9720500	109€
Ø650	670-EWEC14540650	2120€							Ø550	670-EWEC6130550	226€	Ø550	670-EWEC9720550	226€
Ø700	670-EWEC14540700	2631€							Ø600	670-EWEC6130600	241€	Ø600	670-EWEC9720600	241€
Ø750	670-EWEC14540750	2751€							Ø650	670-EWEC6130650	252€	Ø650	670-EWEC9720650	252€
Ø800	670-EWEC14540800	3000€							Ø700	670-EWEC6130700	317€	Ø700	670-EWEC9720700	317€
									Ø750	670-EWEC6130750	330€	Ø750	670-EWEC9720750	330€
									Ø800	670-EWEC6130800	363€	Ø800	670-EWEC9720800	363€



Consultar página 91 para ver distancias de separación.

En los diámetros Ø80 y Ø100 las lamas sobresalen del diámetro del tubo.

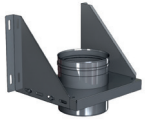

Soporte de carga regulable

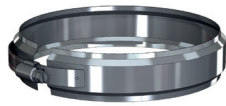

Abrazadera de unión 1.0



Abrazadera fijación pared regulable 50-80mm



Abrazadera fijación pared fija



Abrazadera fijación pared sencilla

Ø80	670-EWEC3790080	62€	Ø80	665-ZUWA450080	6.52€	Ø80	665-ZUWA5560080	30.9€	Ø450	665-ZUWA556F0450	118€	Ø80	665-ZUWA5350080	11.38€
Ø100	670-EWEC3790100	67€	Ø100	665-ZUWA450100	6.52€	Ø100	665-ZUWA5560100	34.15€	Ø500	665-ZUWA556F0500	123€	Ø100	665-ZUWA5350100	14.65€
Ø130	670-EWEC3790130	76€	Ø130	665-ZUWA450130	6.52€	Ø130	665-ZUWA5560130	37.43€	Ø550	665-ZUWA556F0550	155€	Ø130	665-ZUWA5350130	14.65€
Ø150	670-EWEC3790150	95€	Ø150	665-ZUWA450150	8.15€	Ø150	665-ZUWA5560150	39.04€	Ø600	665-ZUWA556F0600	185€	Ø150	665-ZUWA5350150	19.51€
Ø180	670-EWEC3790180	111€	Ø180	665-ZUWA450180	9.75€	Ø180	665-ZUWA5560180	39.04€	Ø650	665-ZUWA556F0650	203€	Ø180	665-ZUWA5350180	26.04€
Ø200	670-EWEC3790200	129€	Ø200	665-ZUWA450200	11.38€	Ø200	665-ZUWA5560200	45.58€	Ø700	665-ZUWA556F0700	264€	Ø200	665-ZUWA5350200	29.27€
Ø250	670-EWEC3790250	161€	Ø250	665-ZUWA450250	21.16€	Ø250	665-ZUWA5560250	61€	Ø750	665-ZUWA556F0750	321€			
Ø300	670-EWEC3790300	191€	Ø300	665-ZUWA450300	26.04€	Ø300	665-ZUWA5560300	64€	Ø800	665-ZUWA556F0800	358€			
Ø350	670-EWEC3790350	211€	Ø350	665-ZUWA450350	29.27€	Ø350	665-ZUWA5560350	67€						
Ø400	670-EWEC3790400	234€	Ø400	665-ZUWA450400	37.43€	Ø400	665-ZUWA5560400	88€						
Ø450	670-EWEC3790450	335€	Ø450	665-ZUWA450450	42.42€	Ø450	665-ZUWA5560450	98€						
Ø500	670-EWEC3790500	471€	Ø500	665-ZUWA450500	47.13€									
Ø550	670-EWEC3790550	681€	Ø550	665-ZUWA450550	50€									
Ø600	670-EWEC3790600	737€	Ø600	665-ZUWA450600	59€									
Ø650	670-EWEC3790650	782€	Ø650	665-ZUWA450650	64€									
Ø700	670-EWEC3790700	968€	Ø700	665-ZUWA450700	77€									
Ø750	670-EWEC3790750	1016€	Ø750	665-ZUWA450750	95€									
Ø800	670-EWEC3790800	1106€	Ø800	665-ZUWA450800	104€									



Base de abrazadera distanciadora



Alas distanciadoras A



Alas distanciadoras B



Alas distanciadoras C



Alas distanciadoras D

Ø80	665-ZUWA14620080	39.04€	Ø80	665-ZUWA1462A	47.13€	Ø80	665-ZUWA1462B	65€	Ø80	665-ZUWA1462C	81€	Ø80	665-ZUWA1462D	104€
Ø100	665-ZUWA14620100	40.87€	Ø100	665-ZUWA1462A	47.13€	Ø100	665-ZUWA1462B	65€	Ø100	665-ZUWA1462C	81€	Ø100	665-ZUWA1462D	104€
Ø130	665-ZUWA14620130	45.58€	Ø130	665-ZUWA1462A	47.13€	Ø130	665-ZUWA1462B	65€	Ø130	665-ZUWA1462C	81€	Ø130	665-ZUWA1462D	104€
Ø150	665-ZUWA14620150	48.72€	Ø150	665-ZUWA1462A	47.13€	Ø150	665-ZUWA1462B	65€	Ø150	665-ZUWA1462C	81€	Ø150	665-ZUWA1462D	104€
Ø180	665-ZUWA14620180	52€	Ø180	665-ZUWA1462A	47.13€	Ø180	665-ZUWA1462B	65€	Ø180	665-ZUWA1462C	81€	Ø180	665-ZUWA1462D	104€
Ø200	665-ZUWA14620200	58€	Ø200	665-ZUWA1462A	47.13€	Ø200	665-ZUWA1462B	65€	Ø200	665-ZUWA1462C	81€	Ø200	665-ZUWA1462D	104€
Ø250	665-ZUWA14620250	100€	Ø250	665-ZUWA1462A	47.13€	Ø250	665-ZUWA1462B	65€	Ø250	665-ZUWA1462C	81€	Ø250	665-ZUWA1462D	104€
Ø300	665-ZUWA14620300	138€	Ø300	665-ZUWA1462A	47.13€	Ø300	665-ZUWA1462B	65€	Ø300	665-ZUWA1462C	81€	Ø300	665-ZUWA1462D	104€
Ø350	665-ZUWA14620350	185€	Ø350	665-ZUWA1462A	47.13€	Ø350	665-ZUWA1462B	65€	Ø350	665-ZUWA1462C	81€	Ø350	665-ZUWA1462D	104€
Ø400	665-ZUWA14620400	241€	Ø400	665-ZUWA1462A	47.13€	Ø400	665-ZUWA1462B	65€	Ø400	665-ZUWA1462C	81€	Ø400	665-ZUWA1462D	104€
Ø450	665-ZUWA14620450	298€	Ø450	665-ZUWA1462A	47.13€	Ø450	665-ZUWA1462B	65€	Ø450	665-ZUWA1462C	81€	Ø450	665-ZUWA1462D	104€
Ø500	665-ZUWA14620500	328€	Ø500	665-ZUWA1462A	47.13€	Ø500	665-ZUWA1462B	65€	Ø500	665-ZUWA1462C	81€	Ø500	665-ZUWA1462D	104€
Ø550	665-ZUWA14620550	365€	Ø550	665-ZUWA1462A	47.13€	Ø550	665-ZUWA1462B	65€	Ø550	665-ZUWA1462C	81€	Ø550	665-ZUWA1462D	104€
Ø600	665-ZUWA14620600	412€	Ø600	665-ZUWA1462A	47.13€	Ø600	665-ZUWA1462B	65€	Ø600	665-ZUWA1462C	81€	Ø600	665-ZUWA1462D	104€
Ø650	665-ZUWA14620650	444€	Ø650	665-ZUWA1462A	47.13€	Ø650	665-ZUWA1462B	65€	Ø650	665-ZUWA1462C	81€	Ø650	665-ZUWA1462D	104€
Ø700	665-ZUWA14620700	572€	Ø700	665-ZUWA1462A	47.13€	Ø700	665-ZUWA1462B	65€	Ø700	665-ZUWA1462C	81€	Ø700	665-ZUWA1462D	104€
Ø750	665-ZUWA14620750	587€	Ø750	665-ZUWA1462A	47.13€	Ø750	665-ZUWA1462B	65€	Ø750	665-ZUWA1462C	81€	Ø750	665-ZUWA1462D	104€
Ø800	665-ZUWA14620800	786€	Ø800	665-ZUWA1462A	47.13€	Ø800	665-ZUWA1462B	65€	Ø800	665-ZUWA1462C	81€	Ø800	665-ZUWA1462D	104€



# CHIMENEA INDIVIDUAL

## Sistema EW - ECO 304



Abrazadera de descenso



Abrazadera de araña

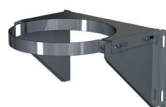

Abrazadera de soporte



Abrazadera con doble  
pértiga telescópica  
L=2000mm



Abrazadera forjado inox

Ø80	665-ZUWA40D0080	14.65€	Ø80	665-ZUWA400080	9.75€	Ø180	665-ZUWA8580180	145€	Ø130	665-ZUWA1910130	144€	Ø80	665-ZUWA620080	17.9€
Ø100	665-ZUWA40D0100	14.65€	Ø100	665-ZUWA400100	9.75€	Ø200	665-ZUWA8580200	145€	Ø150	665-ZUWA1910150	146€	Ø100	665-ZUWA620100	21.16€
Ø130	665-ZUWA40D0130	14.65€	Ø130	665-ZUWA400130	9.75€	Ø250	665-ZUWA8580250	185€	Ø180	665-ZUWA1910180	156€	Ø130	665-ZUWA620130	26.04€
Ø150	665-ZUWA40D0150	19.51€	Ø150	665-ZUWA400150	9.75€	Ø300	665-ZUWA8580300	203€	Ø200	665-ZUWA1910200	173€	Ø150	665-ZUWA620150	30.9€
Ø180	665-ZUWA40D0180	24.4€	Ø180	665-ZUWA400180	14.65€	Ø350	665-ZUWA8580350	221€	Ø250	665-ZUWA1910250	196€	Ø180	665-ZUWA620180	42.42€
Ø200	665-ZUWA40D0200	27.67€	Ø200	665-ZUWA400200	14.65€	Ø400	665-ZUWA8580400	270€	Ø300	665-ZUWA1910300	233€	Ø200	665-ZUWA620200	47.13€
Ø250	665-ZUWA40D0250	40.87€	Ø250	665-ZUWA400250	26.04€	Ø450	665-ZUWA8580450	321€	Ø350	665-ZUWA1910350	249€	Ø250	665-ZUWA620250	50€
Ø300	665-ZUWA40D0300	48.72€	Ø300	665-ZUWA400300	29.27€	Ø500	665-ZUWA8580500	354€	Ø400	665-ZUWA1910400	272€	Ø300	665-ZUWA620300	59€
Ø350	665-ZUWA40D0350	56€	Ø350	665-ZUWA400350	34.15€	Ø550	665-ZUWA8580550	401€	Ø450	665-ZUWA1910450	380€	Ø350	665-ZUWA620350	66€
Ø400	665-ZUWA40D0400	74€	Ø400	665-ZUWA400400	37.43€	Ø600	665-ZUWA8580600	454€	Ø500	665-ZUWA1910500	496€	Ø400	665-ZUWA620400	74€
Ø450	665-ZUWA40D0450	84€	Ø450	665-ZUWA400450	40.87€	Ø650	665-ZUWA8580650	492€	Ø550	665-ZUWA1910550	647€	Ø450	665-ZUWA620450	83€
Ø500	665-ZUWA40D0500	95€	Ø500	665-ZUWA400500	56€	Ø700	665-ZUWA8580700	637€	Ø600	665-ZUWA1910600	699€	Ø500	665-ZUWA620500	96€
Ø550	665-ZUWA40D0550	99€	Ø550	665-ZUWA400550	74€	Ø750	665-ZUWA8580750	780€	Ø650	665-ZUWA1910650	766€	Ø550	665-ZUWA620550	103€
Ø600	665-ZUWA40D0600	117€	Ø600	665-ZUWA400600	98€	Ø800	665-ZUWA8580800	870€	Ø700	665-ZUWA1910700	871€	Ø600	665-ZUWA620600	109€
Ø650	665-ZUWA40D0650	123€	Ø650	665-ZUWA400650	106€				Ø750	665-ZUWA1910750	976€	Ø650	665-ZUWA620650	115€
Ø700	665-ZUWA40D0700	151€	Ø700	665-ZUWA400700	138€				Ø800	665-ZUWA1910800	1127€	Ø700	665-ZUWA620700	122€
Ø750	665-ZUWA40D0750	185€	Ø750	665-ZUWA400750	166€							Ø750	665-ZUWA620750	130€
Ø800	665-ZUWA40D0800	205€	Ø800	665-ZUWA400800	186€							Ø800	665-ZUWA620800	136€



Abrazadera para amarre  
por tornillo



Abrazadera vientos



Collarín antitormenta

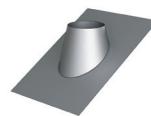

Cubreaguas 25°-45°  
aluminio

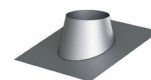

Cubreaguas 5°-25°  
aluminio

Ø80	665-ZUWA10630080	26.04€	Ø80	665-ZUWA420080	9.75€	Ø80	665-ZUWA3070080	26.04€	Ø80	665-ZUWA939AL0080	187€	Ø80	665-ZUWA938AL0080	184€
Ø100	665-ZUWA10630100	29.27€	Ø100	665-ZUWA420100	9.75€	Ø100	665-ZUWA3070100	27.67€	Ø100	665-ZUWA939AL0100	202€	Ø100	665-ZUWA938AL0100	191€
Ø130	665-ZUWA10630130	32.52€	Ø130	665-ZUWA420130	11.38€	Ø130	665-ZUWA3070130	29.27€	Ø130	665-ZUWA939AL0130	219€	Ø130	665-ZUWA938AL0130	206€
Ø150	665-ZUWA10630150	35.77€	Ø150	665-ZUWA420150	14.65€	Ø150	665-ZUWA3070150	34.15€	Ø150	665-ZUWA939AL0150	233€	Ø150	665-ZUWA938AL0150	215€
Ø180	665-ZUWA10630180	39.04€	Ø180	665-ZUWA420180	21.16€	Ø180	665-ZUWA3070180	40.87€	Ø180	665-ZUWA939AL0180	250€	Ø180	665-ZUWA938AL0180	235€
Ø200	665-ZUWA10630200	42.42€	Ø200	665-ZUWA420200	26.04€	Ø200	665-ZUWA3070200	47.13€	Ø200	665-ZUWA939AL0200	269€	Ø200	665-ZUWA938AL0200	252€
Ø250	665-ZUWA10630250	50€	Ø250	665-ZUWA420250	29.27€	Ø250	665-ZUWA3070250	59€	Ø250	665-ZUWA939AL0250	305€	Ø250	665-ZUWA938AL0250	282€
Ø300	665-ZUWA10630300	65€	Ø300	665-ZUWA420300	34.15€	Ø300	665-ZUWA3070300	71€	Ø300	665-ZUWA939AL0300	332€	Ø300	665-ZUWA938AL0300	317€
Ø350	665-ZUWA10630350	74€	Ø350	665-ZUWA420350	37.43€	Ø350	665-ZUWA3070350	77€	Ø350	665-ZUWA939AL0350	387€	Ø350	665-ZUWA938AL0350	351€
Ø400	665-ZUWA10630400	84€	Ø400	665-ZUWA420400	40.87€	Ø400	665-ZUWA3070400	83€	Ø400	665-ZUWA939AL0400	433€	Ø400	665-ZUWA938AL0400	390€
Ø450	665-ZUWA10630450	97€	Ø450	665-ZUWA420450	56€	Ø450	665-ZUWA3070450	114€	Ø450	665-ZUWA939AL0450	492€	Ø450	665-ZUWA938AL0450	436€
Ø500	665-ZUWA10630500	106€	Ø500	665-ZUWA420500	74€	Ø500	665-ZUWA3070500	151€	Ø500	665-ZUWA939AL0500	549€	Ø500	665-ZUWA938AL0500	488€
Ø550	665-ZUWA10630550	114€	Ø550	665-ZUWA420550	98€	Ø550	665-ZUWA3070550	199€	Ø550	665-ZUWA939AL0550	607€	Ø550	665-ZUWA938AL0550	524€
Ø600	665-ZUWA10630600	129€	Ø600	665-ZUWA420600	106€	Ø600	665-ZUWA3070600	211€	Ø600	665-ZUWA939AL0600	661€	Ø600	665-ZUWA938AL0600	573€
Ø650	665-ZUWA10630650	139€	Ø650	665-ZUWA420650	114€	Ø650	665-ZUWA3070650	234€	Ø650	665-ZUWA939AL0650	730€	Ø650	665-ZUWA938AL0650	618€
Ø700	665-ZUWA10630700	151€	Ø700	665-ZUWA420700	151€	Ø700	665-ZUWA3070700	268€	Ø700	665-ZUWA939AL0700	840€	Ø700	665-ZUWA938AL0700	679€
Ø750	665-ZUWA10630750	168€	Ø750	665-ZUWA420750	185€	Ø750	665-ZUWA3070750	296€	Ø750	665-ZUWA939AL0750	939€	Ø750	665-ZUWA938AL0750	736€
Ø800	665-ZUWA10630800	179€	Ø800	665-ZUWA420800	204€	Ø800	665-ZUWA3070800	343€	Ø800	665-ZUWA939AL0800	1123€	Ø800	665-ZUWA938AL0800	880€

**i** Precio unidad. u./c= unidad caja.

**i** Necesario instalar collarín con el cubreaguas.

**i** Consultar página 91 para ver distancias de separación.

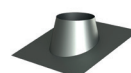
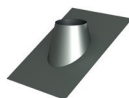
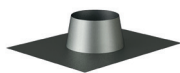
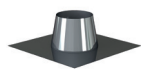

Cubreaguas plano inox

Cubreaguas plomo 0°-5°

Cubreaguas plomo 25°-45°

Cubreaguas plomo 5°-25°

Pasamuros

Ø80	665-ZUWA11280080	144€	Ø80	665-ZUWA9370080	203€	Ø80	665-ZUWA9390080	348€	Ø80	665-ZUWA9380080	203€	Ø80	665-ZUWA9870080	30.9€
Ø100	665-ZUWA11280100	145€	Ø100	665-ZUWA9370100	204€	Ø100	665-ZUWA9390100	356€	Ø100	665-ZUWA9380100	204€	Ø100	665-ZUWA9870100	37.43€
Ø130	665-ZUWA11280130	146€	Ø130	665-ZUWA9370130	205€	Ø130	665-ZUWA9390130	358€	Ø130	665-ZUWA9380130	205€	Ø130	665-ZUWA9870130	39.04€
Ø150	665-ZUWA11280150	150€	Ø150	665-ZUWA9370150	206€	Ø150	665-ZUWA9390150	363€	Ø150	665-ZUWA9380150	206€	Ø150	665-ZUWA9870150	40.87€
Ø180	665-ZUWA11280180	170€	Ø180	665-ZUWA9370180	234€	Ø180	665-ZUWA9390180	379€	Ø180	665-ZUWA9380180	234€	Ø180	665-ZUWA9870180	52€
Ø200	665-ZUWA11280200	185€	Ø200	665-ZUWA9370200	260€	Ø200	665-ZUWA9390200	386€	Ø200	665-ZUWA9380200	260€	Ø200	665-ZUWA9870200	52€
Ø250	665-ZUWA11280250	211€	Ø250	665-ZUWA9370250	294€	Ø250	665-ZUWA9390250	401€	Ø250	665-ZUWA9380250	294€	Ø250	665-ZUWA9870250	65€
Ø300	665-ZUWA11280300	233€	Ø300	665-ZUWA9370300	323€	Ø300	665-ZUWA9390300	417€	Ø300	665-ZUWA9380300	323€	Ø300	665-ZUWA9870300	83€
Ø350	665-ZUWA11280350	260€	Ø350	665-ZUWA9370350	361€	Ø350	665-ZUWA9390350	431€	Ø350	665-ZUWA9380350	361€	Ø350	665-ZUWA9870350	95€
Ø400	665-ZUWA11280400	286€	Ø400	665-ZUWA9370400	396€	Ø400	665-ZUWA9390400	454€	Ø400	665-ZUWA9380400	396€	Ø400	665-ZUWA9870400	121€
Ø450	665-ZUWA11280450	306€	Ø450	665-ZUWA9370450	428€	Ø450	665-ZUWA9390450	541€	Ø450	665-ZUWA9380450	428€	Ø450	665-ZUWA9870450	156€
Ø500	665-ZUWA11280500	352€	Ø500	665-ZUWA9370500	488€	Ø500	665-ZUWA9390500	618€	Ø500	665-ZUWA9380500	488€	Ø500	665-ZUWA9870500	204€
Ø550	665-ZUWA11280550	389€	Ø550	665-ZUWA9370550	539€	Ø550	665-ZUWA9390550	691€	Ø550	665-ZUWA9380550	539€	Ø550	665-ZUWA9870550	221€
Ø600	665-ZUWA11280600	437€	Ø600	665-ZUWA9370600	606€	Ø600	665-ZUWA9390600	775€	Ø600	665-ZUWA9380600	606€	Ø600	665-ZUWA9870600	244€
Ø650	665-ZUWA11280650	492€	Ø650	665-ZUWA9370650	684€	Ø650	665-ZUWA9390650	869€	Ø650	665-ZUWA9380650	684€	Ø650	665-ZUWA9870650	271€
Ø700	665-ZUWA11280700	551€	Ø700	665-ZUWA9370700	763€	Ø700	665-ZUWA9390700	971€	Ø700	665-ZUWA9380700	763€	Ø700	665-ZUWA9870700	337€
Ø750	665-ZUWA11280750	587€	Ø750	665-ZUWA9370750	815€	Ø750	665-ZUWA9390750	1034€	Ø750	665-ZUWA9380750	815€	Ø750	665-ZUWA9870750	398€
Ø800	665-ZUWA11280800	614€	Ø800	665-ZUWA9370800	850€	Ø800	665-ZUWA9390800	1082€	Ø800	665-ZUWA9380800	850€	Ø800	665-ZUWA9870800	466€



Junta de silicona  
(T<200°C)

Ø80	665-ZUWA260080	4.88€
Ø100	665-ZUWA260100	4.88€
Ø130	665-ZUWA260130	4.88€
Ø150	665-ZUWA260150	4.88€
Ø180	665-ZUWA260180	6.52€
Ø200	665-ZUWA260200	8.15€
Ø250	665-ZUWA260250	11.38€
Ø300	665-ZUWA260300	14.65€
Ø350	665-ZUWA260350	17.9€
Ø400	665-ZUWA260400	19.51€
Ø450	665-ZUWA260450	21.16€
Ø500	665-ZUWA260500	24.4€
Ø550	665-ZUWA260550	27.67€
Ø600	665-ZUWA260600	30.9€
Ø650	665-ZUWA260650	35.77€
Ø700	665-ZUWA260700	40.87€
Ø750	665-ZUWA260750	45.58€
Ø800	665-ZUWA260800	48.72€



# CHIMENEA INDIVIDUAL

## Sistema EW - ECO 304

### ADAPTADOR CALDERA HEMBRA

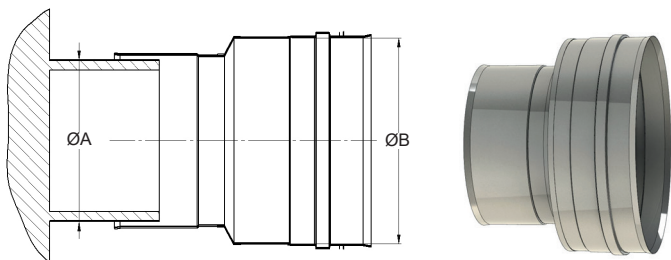

CÓDIGO	Ø A	Ø B	€
670-EWEC37H00800080	Ø80	Ø80	22.77€
670-EWEC37H00800100	Ø80	Ø100	54€
670-EWEC37H00800130	Ø80	Ø130	56€
670-EWEC37H01000080	Ø100	Ø80	54€
670-EWEC37H01000100	Ø100	Ø100	24.4€
670-EWEC37H01000130	Ø100	Ø130	56€
670-EWEC37H01000150	Ø100	Ø150	65€
670-EWEC37H01100080	Ø110	Ø80	54€
670-EWEC37H01100100	Ø110	Ø100	58€
670-EWEC37H01100130	Ø110	Ø130	56€
670-EWEC37H01100150	Ø110	Ø150	65€
670-EWEC37H01200080	Ø120	Ø80	56€
670-EWEC37H01200100	Ø120	Ø100	58€
670-EWEC37H01200130	Ø120	Ø130	56€
670-EWEC37H01200150	Ø120	Ø150	65€
670-EWEC37H01250080	Ø125	Ø80	56€
670-EWEC37H01250100	Ø125	Ø100	58€
670-EWEC37H01250130	Ø125	Ø130	26.04€
670-EWEC37H01250150	Ø125	Ø150	65€
670-EWEC37H01300080	Ø130	Ø80	56€
670-EWEC37H01300100	Ø130	Ø100	58€
670-EWEC37H01300130	Ø130	Ø130	26.04€
670-EWEC37H01300150	Ø130	Ø150	66€
670-EWEC37H01300180	Ø130	Ø180	78€
670-EWEC37H01350080	Ø135	Ø80	80€
670-EWEC37H01350100	Ø135	Ø100	73€
670-EWEC37H01350130	Ø135	Ø130	26.04€
670-EWEC37H01350150	Ø135	Ø150	66€
670-EWEC37H01350180	Ø135	Ø180	78€
670-EWEC37H01400080	Ø140	Ø80	129€
670-EWEC37H01400100	Ø140	Ø100	73€
670-EWEC37H01400130	Ø140	Ø130	73€
670-EWEC37H01400150	Ø140	Ø150	29.27€
670-EWEC37H01400180	Ø140	Ø180	78€
670-EWEC37H01500080	Ø150	Ø80	129€
670-EWEC37H01500100	Ø150	Ø100	73€
670-EWEC37H01500130	Ø150	Ø130	73€
670-EWEC37H01500150	Ø150	Ø150	29.27€
670-EWEC37H01500180	Ø150	Ø180	80€
670-EWEC37H01500200	Ø150	Ø200	91€
670-EWEC37H01600080	Ø160	Ø80	146€
670-EWEC37H01600100	Ø160	Ø100	84€
670-EWEC37H01600130	Ø160	Ø130	84€
670-EWEC37H01600150	Ø160	Ø150	29.27€
670-EWEC37H01600180	Ø160	Ø180	80€
670-EWEC37H01600200	Ø160	Ø200	91€
670-EWEC37H01750080	Ø175	Ø80	146€
670-EWEC37H01750130	Ø175	Ø130	84€
670-EWEC37H01750150	Ø175	Ø150	81€
670-EWEC37H01750180	Ø175	Ø180	35.77€
670-EWEC37H01750200	Ø175	Ø200	91€

670-EWEC37H01800080	Ø180	Ø80	146€
670-EWEC37H01800100	Ø180	Ø100	84€
670-EWEC37H01800130	Ø180	Ø130	84€
670-EWEC37H01800150	Ø180	Ø150	81€
670-EWEC37H01800180	Ø180	Ø180	35.77€
670-EWEC37H01800200	Ø180	Ø200	95€
670-EWEC37H01800250	Ø180	Ø250	98€
670-EWEC37H02000150	Ø200	Ø150	95€
670-EWEC37H02000180	Ø200	Ø180	91€
670-EWEC37H02000200	Ø200	Ø200	40.87€
670-EWEC37H02000250	Ø200	Ø250	99€
670-EWEC37H02000300	Ø200	Ø300	129€
670-EWEC37H02250180	Ø225	Ø180	97€
670-EWEC37H02250200	Ø225	Ø200	97€
670-EWEC37H02250250	Ø225	Ø250	99€
670-EWEC37H02250300	Ø225	Ø300	129€
670-EWEC37H02500180	Ø250	Ø180	97€
670-EWEC37H02500200	Ø250	Ø200	97€
670-EWEC37H02500250	Ø250	Ø250	48.72€
670-EWEC37H02500300	Ø250	Ø300	131€
670-EWEC37H02500350	Ø250	Ø350	137€
670-EWEC37H03000200	Ø300	Ø200	129€
670-EWEC37H03000250	Ø300	Ø250	133€
670-EWEC37H03000300	Ø300	Ø300	56€
670-EWEC37H03000350	Ø300	Ø350	138€
670-EWEC37H03000400	Ø300	Ø400	161€
670-EWEC37H03500250	Ø350	Ø250	151€
670-EWEC37H03500300	Ø350	Ø300	152€
670-EWEC37H03500350	Ø350	Ø350	65€
670-EWEC37H03500400	Ø350	Ø400	168€
670-EWEC37H03500450	Ø350	Ø450	266€
670-EWEC37H04000300	Ø400	Ø300	169€
670-EWEC37H04000350	Ø400	Ø350	160€
670-EWEC37H04000400	Ø400	Ø400	73€
670-EWEC37H04000450	Ø400	Ø450	268€
670-EWEC37H04000500	Ø400	Ø500	361€
670-EWEC37H04500350	Ø450	Ø350	219€
670-EWEC37H04500400	Ø450	Ø400	233€
670-EWEC37H04500450	Ø450	Ø450	99€
670-EWEC37H04500500	Ø450	Ø500	365€
670-EWEC37H04500550	Ø450	Ø550	655€
670-EWEC37H05000400	Ø500	Ø400	235€
670-EWEC37H05000450	Ø500	Ø450	275€
670-EWEC37H05000500	Ø500	Ø500	140€
670-EWEC37H05000550	Ø500	Ø550	659€
670-EWEC37H05000600	Ø500	Ø600	590€
670-EWEC37H05500450	Ø550	Ø450	406€
670-EWEC37H05500500	Ø550	Ø500	540€
670-EWEC37H05500550	Ø550	Ø550	196€
670-EWEC37H05500600	Ø550	Ø600	592€
670-EWEC37H05500650	Ø550	Ø650	636€
670-EWEC37H06000500	Ø600	Ø500	557€
670-EWEC37H06000550	Ø600	Ø550	686€
670-EWEC37H06000600	Ø600	Ø600	196€
670-EWEC37H06000650	Ø600	Ø650	640€
670-EWEC37H06000700	Ø600	Ø700	685€
670-EWEC37H06500650	Ø650	Ø650	211€
670-EWEC37H06500700	Ø650	Ø700	690€
670-EWEC37H06500750	Ø650	Ø750	732€
670-EWEC37H07000700	Ø700	Ø700	227€
670-EWEC37H07000750	Ø700	Ø750	737€
670-EWEC37H07000800	Ø700	Ø800	782€
670-EWEC37H07500750	Ø750	Ø750	245€
670-EWEC37H07500800	Ø750	Ø800	786€
670-EWEC37H08000800	Ø800	Ø800	264€

## ADAPTADOR CALDERA MACHO

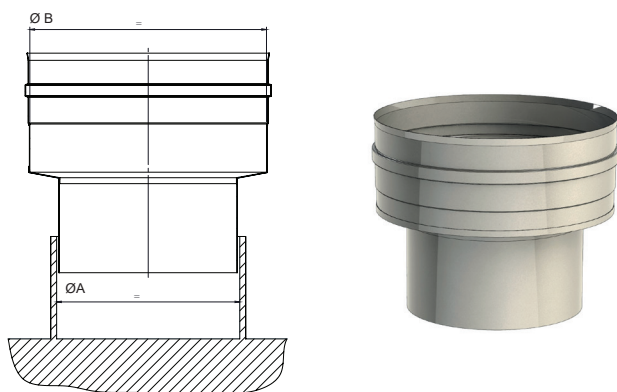

CÓDIGO	Ø A	Ø B	€
670-EWEC37M00800080	Ø80	Ø80	22.77€
670-EWEC37M00800100	Ø80	Ø100	54€
670-EWEC37M00800130	Ø80	Ø130	56€
670-EWEC37M01000080	Ø100	Ø80	54€
670-EWEC37M01000100	Ø100	Ø100	24.4€
670-EWEC37M01000130	Ø100	Ø130	56€
670-EWEC37M01000150	Ø100	Ø150	65€
670-EWEC37M01100080	Ø110	Ø80	54€
670-EWEC37M01100100	Ø110	Ø100	58€
670-EWEC37M01100130	Ø110	Ø130	56€
670-EWEC37M01100150	Ø110	Ø150	65€
670-EWEC37M01200080	Ø120	Ø80	56€
670-EWEC37M01200100	Ø120	Ø100	58€
670-EWEC37M01200130	Ø120	Ø130	56€
670-EWEC37M01200150	Ø120	Ø150	65€
670-EWEC37M01250080	Ø125	Ø80	56€
670-EWEC37M01250100	Ø125	Ø100	58€
670-EWEC37M01250130	Ø125	Ø130	26.04€
670-EWEC37M01250150	Ø125	Ø150	65€
670-EWEC37M01300080	Ø130	Ø80	56€
670-EWEC37M01300100	Ø130	Ø100	58€
670-EWEC37M01300130	Ø130	Ø130	26.04€
670-EWEC37M01300150	Ø130	Ø150	66€
670-EWEC37M01300180	Ø130	Ø180	78€
670-EWEC37M01350100	Ø135	Ø100	73€
670-EWEC37M01350130	Ø135	Ø130	26.04€
670-EWEC37M01350150	Ø135	Ø150	66€
670-EWEC37M01350180	Ø135	Ø180	78€
670-EWEC37M01400100	Ø140	Ø100	73€
670-EWEC37M01400130	Ø140	Ø130	73€
670-EWEC37M01400150	Ø140	Ø150	29.27€
670-EWEC37M01400180	Ø140	Ø180	78€
670-EWEC37M01500100	Ø150	Ø100	73€
670-EWEC37M01500130	Ø150	Ø130	73€
670-EWEC37M01500150	Ø150	Ø150	29.27€
670-EWEC37M01500180	Ø150	Ø180	80€
670-EWEC37M01500200	Ø150	Ø200	91€
670-EWEC37M01600130	Ø160	Ø130	84€
670-EWEC37M01600150	Ø160	Ø150	29.27€
670-EWEC37M01600180	Ø160	Ø180	80€
670-EWEC37M01600200	Ø160	Ø200	91€
670-EWEC37M01750130	Ø175	Ø130	84€
670-EWEC37M01750150	Ø175	Ø150	81€
670-EWEC37M01750180	Ø175	Ø180	35.77€
670-EWEC37M01750200	Ø175	Ø200	91€
670-EWEC37M01800130	Ø180	Ø130	84€
670-EWEC37M01800150	Ø180	Ø150	81€
670-EWEC37M01800180	Ø180	Ø180	35.77€
670-EWEC37M01800200	Ø180	Ø200	95€
670-EWEC37M01800250	Ø180	Ø250	98€
670-EWEC37M02000150	Ø200	Ø150	95€

670-EWEC37M02000180	Ø200	Ø180	91€
670-EWEC37M02000200	Ø200	Ø200	40.87€
670-EWEC37M02000250	Ø200	Ø250	99€
670-EWEC37M02000300	Ø200	Ø300	129€
670-EWEC37M02250180	Ø225	Ø180	97€
670-EWEC37M02250200	Ø225	Ø200	97€
670-EWEC37M02250250	Ø225	Ø250	99€
670-EWEC37M02250300	Ø225	Ø300	129€
670-EWEC37M02500180	Ø250	Ø180	97€
670-EWEC37M02500200	Ø250	Ø200	97€
670-EWEC37M02500250	Ø250	Ø250	48.72€
670-EWEC37M02500300	Ø250	Ø300	131€
670-EWEC37M02500350	Ø250	Ø350	137€
670-EWEC37M03000250	Ø300	Ø250	133€
670-EWEC37M03000300	Ø300	Ø300	56€
670-EWEC37M03000350	Ø300	Ø350	138€
670-EWEC37M03000400	Ø300	Ø400	161€
670-EWEC37M03500250	Ø350	Ø250	151€
670-EWEC37M03500300	Ø350	Ø300	152€
670-EWEC37M03500350	Ø350	Ø350	65€
670-EWEC37M03500400	Ø350	Ø400	168€
670-EWEC37M03500450	Ø350	Ø450	266€
670-EWEC37M04000300	Ø400	Ø300	169€
670-EWEC37M04000350	Ø400	Ø350	160€
670-EWEC37M04000400	Ø400	Ø400	73€
670-EWEC37M04000450	Ø400	Ø450	268€
670-EWEC37M04000500	Ø400	Ø500	361€
670-EWEC37M04500350	Ø450	Ø350	219€
670-EWEC37M04500400	Ø450	Ø400	233€
670-EWEC37M04500450	Ø450	Ø450	99€
670-EWEC37M04500500	Ø450	Ø500	365€
670-EWEC37M04500550	Ø450	Ø550	655€
670-EWEC37M05000400	Ø500	Ø400	235€
670-EWEC37M05000450	Ø500	Ø450	275€
670-EWEC37M05000500	Ø500	Ø500	140€
670-EWEC37M05000550	Ø500	Ø550	659€
670-EWEC37M05000600	Ø500	Ø600	590€
670-EWEC37M05500450	Ø550	Ø450	406€
670-EWEC37M05500500	Ø550	Ø500	540€
670-EWEC37M05500550	Ø550	Ø550	196€
670-EWEC37M05500600	Ø550	Ø600	592€
670-EWEC37M05500650	Ø550	Ø650	636€
670-EWEC37M06000500	Ø600	Ø500	557€
670-EWEC37M06000550	Ø600	Ø550	686€
670-EWEC37M06000600	Ø600	Ø600	196€
670-EWEC37M06000650	Ø600	Ø650	640€
670-EWEC37M06000700	Ø600	Ø700	685€
670-EWEC37M06500650	Ø650	Ø650	211€
670-EWEC37M06500700	Ø650	Ø700	690€
670-EWEC37M06500750	Ø650	Ø750	732€
670-EWEC37M07000700	Ø700	Ø700	227€
670-EWEC37M07000750	Ø700	Ø750	737€
670-EWEC37M07000800	Ø700	Ø800	782€
670-EWEC37M07500750	Ø750	Ø750	245€
670-EWEC37M07500800	Ø750	Ø800	786€
670-EWEC37M08000800	Ø800	Ø800	264€



# CHIMENEA INDIVIDUAL

## Sistema EW - ECO 304

### AMPLIACIONES

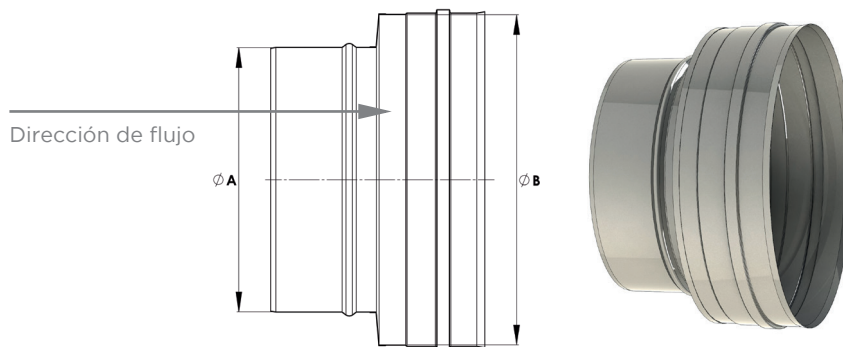

CÓDIGO	Ø A	Ø B	€
670-EWECA00800100	Ø80	Ø100	50€
670-EWECA00800130	Ø80	Ø130	74€
670-EWECA00800150	Ø80	Ø150	91€
670-EWECA00800180	Ø80	Ø180	110€
670-EWECA01000130	Ø100	Ø130	71€
670-EWECA01000150	Ø100	Ø150	87€
670-EWECA01000180	Ø100	Ø180	106€
670-EWECA01000200	Ø100	Ø200	133€
670-EWECA01250130	Ø125	Ø130	65€
670-EWECA01250150	Ø125	Ø150	83€
670-EWECA01250180	Ø125	Ø180	100€
670-EWECA01250200	Ø125	Ø200	129€
670-EWECA01250250	Ø125	Ø250	157€
670-EWECA01300150	Ø130	Ø150	76€
670-EWECA01300180	Ø130	Ø180	98€
670-EWECA01300200	Ø130	Ø200	123€
670-EWECA01300250	Ø130	Ø250	151€
670-EWECA01300300	Ø130	Ø300	191€
670-EWECA01500180	Ø150	Ø180	90€
670-EWECA01500200	Ø150	Ø200	119€
670-EWECA01500250	Ø150	Ø250	143€
670-EWECA01500300	Ø150	Ø300	184€
670-EWECA01500350	Ø150	Ø350	221€
670-EWECA01800200	Ø180	Ø200	107€
670-EWECA01800250	Ø180	Ø250	139€
670-EWECA01800300	Ø180	Ø300	177€
670-EWECA01800350	Ø180	Ø350	212€
670-EWECA01800400	Ø180	Ø400	271€
670-EWECA02000250	Ø200	Ø250	127€
670-EWECA02000300	Ø200	Ø300	169€
670-EWECA02000350	Ø200	Ø350	205€
670-EWECA02000400	Ø200	Ø400	260€
670-EWECA02000450	Ø200	Ø450	290€
670-EWECA02500300	Ø250	Ø300	155€
670-EWECA02500350	Ø250	Ø350	199€
670-EWECA02500400	Ø250	Ø400	249€
670-EWECA02500450	Ø250	Ø450	278€
670-EWECA02500500	Ø250	Ø500	305€
670-EWECA03000350	Ø300	Ø350	178€

670-EWECA03000400	Ø300	Ø400	241€
670-EWECA03000450	Ø300	Ø450	268€
670-EWECA03000500	Ø300	Ø500	295€
670-EWECA03000550	Ø300	Ø550	337€
670-EWECA03500400	Ø350	Ø400	218€
670-EWECA03500450	Ø350	Ø450	252€
670-EWECA03500500	Ø350	Ø500	283€
670-EWECA03500550	Ø350	Ø550	327€
670-EWECA03500600	Ø350	Ø600	348€
670-EWECA04000450	Ø400	Ø450	234€
670-EWECA04000500	Ø400	Ø500	269€
670-EWECA04000550	Ø400	Ø550	313€
670-EWECA04000600	Ø400	Ø600	334€
670-EWECA04000650	Ø400	Ø650	368€
670-EWECA04500500	Ø450	Ø500	245€
670-EWECA04500550	Ø450	Ø550	298€
670-EWECA04500600	Ø450	Ø600	321€
670-EWECA04500650	Ø450	Ø650	357€
670-EWECA04500700	Ø450	Ø700	457€
670-EWECA05000550	Ø500	Ø550	271€
670-EWECA05000600	Ø500	Ø600	305€
670-EWECA05000650	Ø500	Ø650	338€
670-EWECA05000700	Ø500	Ø700	439€
670-EWECA05000750	Ø500	Ø750	478€
670-EWECA05500600	Ø550	Ø600	278€
670-EWECA05500650	Ø550	Ø650	327€
670-EWECA05500700	Ø550	Ø700	420€
670-EWECA05500750	Ø550	Ø750	458€
670-EWECA05500800	Ø550	Ø800	522€
670-EWECA06000650	Ø600	Ø650	296€
670-EWECA06000700	Ø600	Ø700	406€
670-EWECA06000750	Ø600	Ø750	441€
670-EWECA06000800	Ø600	Ø800	503€
670-EWECA06500700	Ø650	Ø700	366€
670-EWECA06500750	Ø650	Ø750	421€
670-EWECA06500800	Ø650	Ø800	481€
670-EWECA07000750	Ø700	Ø750	384€
670-EWECA07000800	Ø700	Ø800	458€
670-EWECA07500800	Ø750	Ø800	417€

## REDUCCIONES

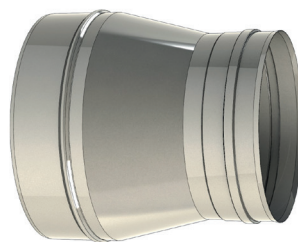
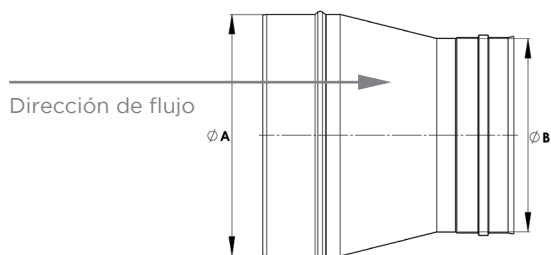

CÓDIGO	$\varnothing A$	$\varnothing B$	€
670-EWECR01000080	Ø100	Ø80	50€
670-EWECR01250080	Ø125	Ø80	71€
670-EWECR01250100	Ø125	Ø100	65€
670-EWECR01300080	Ø130	Ø80	74€
670-EWECR01300100	Ø130	Ø100	71€
670-EWECR01500080	Ø150	Ø80	91€
670-EWECR01500100	Ø150	Ø100	87€
670-EWECR01500130	Ø150	Ø130	76€
670-EWECR01800080	Ø180	Ø80	110€
670-EWECR01800100	Ø180	Ø100	106€
670-EWECR01800130	Ø180	Ø130	98€
670-EWECR01800150	Ø180	Ø150	90€
670-EWECR02000100	Ø200	Ø100	133€
670-EWECR02000130	Ø200	Ø130	123€
670-EWECR02000150	Ø200	Ø150	119€
670-EWECR02000180	Ø200	Ø180	107€
670-EWECR02500130	Ø250	Ø130	151€
670-EWECR02500150	Ø250	Ø150	143€
670-EWECR02500180	Ø250	Ø180	139€
670-EWECR02500200	Ø250	Ø200	127€
670-EWECR03000130	Ø300	Ø130	191€
670-EWECR03000150	Ø300	Ø150	184€
670-EWECR03000180	Ø300	Ø180	177€
670-EWECR03000200	Ø300	Ø200	169€
670-EWECR03000250	Ø300	Ø250	155€
670-EWECR03500150	Ø350	Ø150	221€
670-EWECR03500180	Ø350	Ø180	212€
670-EWECR03500200	Ø350	Ø200	205€
670-EWECR03500250	Ø350	Ø250	199€
670-EWECR03500300	Ø350	Ø300	178€
670-EWECR04000180	Ø400	Ø180	271€
670-EWECR04000200	Ø400	Ø200	260€
670-EWECR04000250	Ø400	Ø250	249€
670-EWECR04000300	Ø400	Ø300	241€
670-EWECR04000350	Ø400	Ø350	218€
670-EWECR04500200	Ø450	Ø200	290€
670-EWECR04500250	Ø450	Ø250	278€

670-EWECR04500300	Ø450	Ø300	268€
670-EWECR04500350	Ø450	Ø350	252€
670-EWECR04500400	Ø450	Ø400	234€
670-EWECR05000250	Ø500	Ø250	305€
670-EWECR05000300	Ø500	Ø300	295€
670-EWECR05000350	Ø500	Ø350	283€
670-EWECR05000400	Ø500	Ø400	269€
670-EWECR05000450	Ø500	Ø450	245€
670-EWECR05500300	Ø550	Ø300	337€
670-EWECR05500350	Ø550	Ø350	327€
670-EWECR05500400	Ø550	Ø400	313€
670-EWECR05500450	Ø550	Ø450	298€
670-EWECR05500500	Ø550	Ø500	271€
670-EWECR06000350	Ø600	Ø350	348€
670-EWECR06000400	Ø600	Ø400	334€
670-EWECR06000450	Ø600	Ø450	321€
670-EWECR06000500	Ø600	Ø500	305€
670-EWECR06000550	Ø600	Ø550	278€
670-EWECR06500400	Ø650	Ø400	368€
670-EWECR06500450	Ø650	Ø450	357€
670-EWECR06500500	Ø650	Ø500	338€
670-EWECR06500550	Ø650	Ø550	327€
670-EWECR06500600	Ø650	Ø600	296€
670-EWECR07000450	Ø700	Ø450	457€
670-EWECR07000500	Ø700	Ø500	439€
670-EWECR07000550	Ø700	Ø550	420€
670-EWECR07000600	Ø700	Ø600	406€
670-EWECR07000650	Ø700	Ø650	366€
670-EWECR07500500	Ø750	Ø500	478€
670-EWECR07500550	Ø750	Ø550	458€
670-EWECR07500600	Ø750	Ø600	441€
670-EWECR07500650	Ø750	Ø650	421€
670-EWECR07500700	Ø750	Ø700	384€
670-EWECR08000550	Ø800	Ø550	522€
670-EWECR08000600	Ø800	Ø600	503€
670-EWECR08000650	Ø800	Ø650	481€
670-EWECR08000700	Ø800	Ø700	458€
670-EWECR08000750	Ø800	Ø750	417€



# CHIMENEA INDIVIDUAL

## Sistema TWIN-ECO 316

Chimenea modular metálica para evacuación de humos y gases de los productos de la combustión y admisión de aire en doble pared concéntrica fabricada en acero inoxidable interior y exterior.

### MATERIAL

Pared Interior: AISI 316L

Pared Exterior: AISI 304

### ACABADO EXTERIOR

Brillante

Pintado negro exterior: consultar precios

Exterior galvanizado (sólo tramos rectos y desviaciones): consultar precios

### ESPESORES (mm)

Pared interior: 0,4 mm

Pared exterior: 0,4 mm

### DIÁMETROS DISPONIBLES (mm)

Ø80/125 - Ø100/150 - Ø130/200

### SISTEMA DE UNIÓN

Conexión macho-hembra con **abrazadera de unión sencilla**

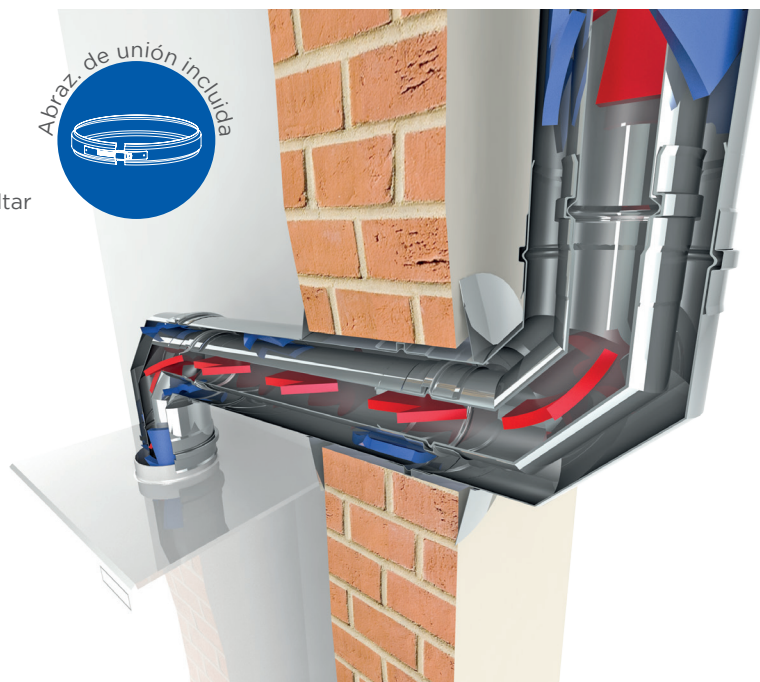

### APLICACIONES

- Calderas de condensación estancas
- Instalación individual
- Circuito de entrada de aire y salida de humos aislado del interior de la vivienda



### CARACTERÍSTICAS

- Temperatura de trabajo hasta 200°C
- Soldadura LÁSER en continuo en todas las piezas
- **Abrazadera de unión INCLUIDA**
- **Para condensación es necesaria la junta de condensación en las uniones y una pendiente mínima de 3° en tramos horizontales**

### CERTIFICADO CE

0036 CPR 9174 031

### CLASIFICACIONES CE (UNE-EN 1856-1)

T120 - P1 - W - V2 - L50040 - O(00) (con junta DW2526C)

T200 - N1 - W - V2 - L50040 - O(00)



Módulo recto 1000mm



Módulo recto 500mm



Módulo recto 250mm



Módulo recto regulable  
320-480mm



Codo 45°

Ø80	646-TWEC130080	151€	Ø80	646-TWEC140080	107€	Ø80	646-TWEC150080	78€	Ø80	646-TWEC500080	200€	Ø80	646-TWEC180080	107€
Ø100	646-TWEC130100	156€	Ø100	646-TWEC140100	111€	Ø100	646-TWEC150100	81€	Ø100	646-TWEC500100	212€	Ø100	646-TWEC180100	111€
Ø130	646-TWEC130130	161€	Ø130	646-TWEC140130	117€	Ø130	646-TWEC150130	83€	Ø130	646-TWEC500130	227€	Ø130	646-TWEC180130	117€



Codo 87°



Codo 90°



Te 87°



Te 90°



Te 135°

Ø80	646-TWEC640080	155€	Ø80	646-TWEC600080	155€	Ø80	646-TWEC110080	264€	Ø80	646-TWEC3170080	221€	Ø80	646-TWEC120080	319€
Ø100	646-TWEC640100	161€	Ø100	646-TWEC600100	161€	Ø100	646-TWEC110100	271€	Ø100	646-TWEC3170100	234€	Ø100	646-TWEC120100	330€
Ø130	646-TWEC640130	163€	Ø130	646-TWEC600130	163€	Ø130	646-TWEC110130	283€	Ø130	646-TWEC3170130	239€	Ø130	646-TWEC120130	338€

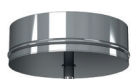

Colector de hollín con  
desagüe

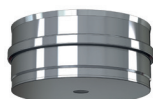

Colector interior para  
sobrepresión (incl. Junta)



Módulo de inspección



Módulo de inspección con  
tapa 200 Pa (P1)



Módulo de inspección con  
tapa 40 Pa (N1)

Ø80	646-TWEC440080	50€	Ø80	680-SED244S0080	47.13€	Ø80	646-TWEC510080	121€	Ø80	646-TWEC5490080	249€	Ø80	646-TWEC680080	196€
Ø100	646-TWEC440100	52€	Ø100	680-SED244S0100	50€	Ø100	646-TWEC510100	107€	Ø100	646-TWEC5490100	264€	Ø100	646-TWEC680100	205€
Ø130	646-TWEC440130	61€	Ø130	680-SED244S0130	54€	Ø130	646-TWEC510130	127€	Ø130	646-TWEC5490130	268€	Ø130	646-TWEC680130	207€



Terminal horizontal  
cortable



Terminal horizontal corto



Terminal vertical



Terminal vertical corto



Adaptador caldera coaxial

Ø80	646-TWEC360080	274€	Ø80	646-TWEC36C0080	247€	Ø80	646-TWEC3580080	313€	Ø80	646-TWEC358C0080	280€	Ø80	646-TWEC1820080	61€
Ø100	646-TWEC360100	296€	Ø100	646-TWEC36C0100	267€	Ø100	646-TWEC3580100	327€	Ø100	646-TWEC358C0100	295€	Ø100	646-TWEC1820100	65€
Ø130	646-TWEC360130	311€	Ø130	646-TWEC36C0130	280€	Ø130	646-TWEC3580130	333€	Ø130	646-TWEC358C0130	298€	Ø130	646-TWEC1820130	74€



# CHIMENEA INDIVIDUAL

## Sistema TWIN-ECO 316



Precio unidad. u/c= unidad caja.



Necesario instalar collarin con el cubreaguas.



Adaptador caldera coaxial con toma muestras

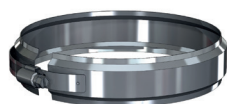

Abrazadera de unión 1.0

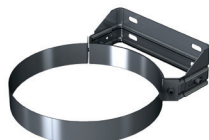

Abrazadera fijación pared regulable 50-80mm



Abrazadera fijación pared sencilla



Abrazadera de araña

Ø80	646-TWEC1830080	121€	Ø80	665-ZUWA450125	6.52€	Ø80	665-ZUWA5560125	37.43€	Ø80	665-ZUWA5350125	14.65€	Ø80	665-ZUWA400125	9.75€
Ø100	646-TWEC1830100	107€	Ø100	665-ZUWA450150	8.15€	Ø100	665-ZUWA5560150	39.04€	Ø100	665-ZUWA5350150	19.51€	Ø100	665-ZUWA400150	9.75€
Ø130	646-TWEC1830130	127€	Ø130	665-ZUWA450200	11.38€	Ø130	665-ZUWA5560200	45.58€	Ø130	665-ZUWA5350200	29.27€	Ø130	665-ZUWA400200	14.65€



Abrazadera con doble pértiga telescópica L=2000mm

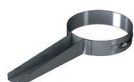

Abrazadera forjado inox



Abrazadera vientos



Soporte de techo



Collarín antitormenta

Ø80	665-ZUWA1910125	144€	Ø80	665-ZUWA620125	26.04€	Ø80	665-ZUWA420125	11.38€	Ø80	665-ZUWA9360125	34.15€	Ø80	665-ZUWA3070125	29.27€
Ø100	665-ZUWA1910150	146€	Ø100	665-ZUWA620150	30.9€	Ø100	665-ZUWA420150	14.65€	Ø100	665-ZUWA9360150	40.87€	Ø100	665-ZUWA3070150	34.15€
Ø130	665-ZUWA1910200	173€	Ø130	665-ZUWA620200	47.13€	Ø130	665-ZUWA420200	26.04€	Ø130	665-ZUWA9360200	56€	Ø130	665-ZUWA3070200	47.13€

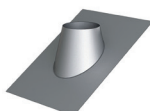

Cubreaguas 25°-45° aluminio

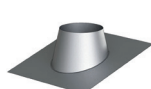

Cubreaguas 5°-25° aluminio



Cubreaguas plano inox

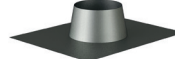

Cubreaguas plomo 0°-5°

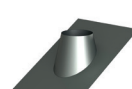

Cubreaguas plomo 25°-45°



Ø80	665-ZUWA939AL0125	219€	Ø80	665-ZUWA938AL0125	206€	Ø80	665-ZUWA11280125	146€	Ø80	665-ZUWA9370125	205€	Ø80	665-ZUWA9390125	358€
Ø100	665-ZUWA939AL0150	233€	Ø100	665-ZUWA938AL0150	215€	Ø100	665-ZUWA11280150	150€	Ø100	665-ZUWA9370150	206€	Ø100	665-ZUWA9390150	363€
Ø130	665-ZUWA939AL0200	269€	Ø130	665-ZUWA938AL0200	252€	Ø130	665-ZUWA11280200	185€	Ø130	665-ZUWA9370200	260€	Ø130	665-ZUWA9390200	386€

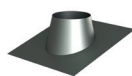

Cubreaguas plomo 5°-25°



Pasamuros



Junta EPDM (T<120°C)



Ø80	665-ZUWA9380125	205€	Ø80	665-ZUWA9870125	39.04€	Ø80	665-ZUWA26C0080	4.88€
Ø100	665-ZUWA9380150	206€	Ø100	665-ZUWA9870150	40.87€	Ø100	665-ZUWA26C0100	4.88€
Ø130	665-ZUWA9380200	260€	Ø130	665-ZUWA9870200	52€	Ø130	665-ZUWA26C0130	4.88€

# ABRAZADERAS DE SEPARACIÓN

El nuevo sistema de abrazaderas de separación se ha desarrollado para mejorar el diseño de las fijaciones, aumentando la resistencia mecánica de las alas y el cuerpo de la abrazadera simplificando al mismo tiempo el diseño de las mismas.

Además permite una mayor flexibilidad a la hora de utilizar unas u otras alas, al ser independientes las alas de los cuerpos. Pudiendo lograrse separaciones de hasta 600 mm desde la pared hasta la parte trasera del tubo.

El sistema consta del cuerpo de la abrazadera, que es común para cada diámetro, y de cuatro modelos de alas. De tal modo que combinando el cuerpo de cada diámetro con cada uno de los modelos de alas se consiguen las distancias máximas de separación entre la pared y la parte posterior del conducto indicadas en las siguientes tablas (en mm). La distancia mínima en todos los casos es de 50 mm.

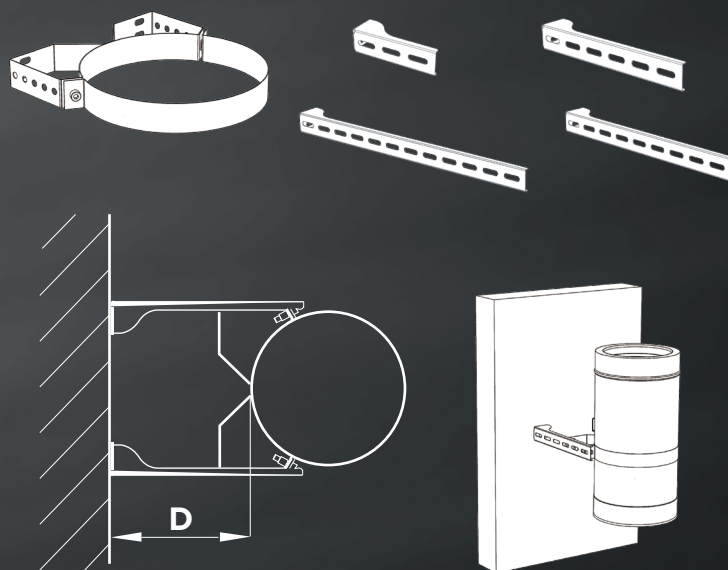

## DW-ECO 1.0; DW-ECO 2.0; DW-ECO EI30

	80	100	130	150	180	200	250	300	350	400	450	500	550	600	650	700	750	800
1462A	140	140	125	120	105	100	80	65	50	-	-	-	-	-	-	-	-	-
1462B	290	290	275	270	255	250	230	215	200	175	150	135	110	85	-	-	-	-
1462C	440	440	425	420	405	400	380	365	365	325	300	285	260	235	190	170	150	125
1462D	590	590	575	570	555	550	530	515	500	475	450	435	410	385	340	320	300	275

## DW-KL 32

	80	100	130	150	180	200	250	300	350	400	450	500	550	600	650	700	750	800
1462A	140	125	120	105	100	80	65	50	-	-	-	-	-	-	-	-	-	-
1462B	290	275	270	255	250	230	215	200	175	150	135	110	85	65	-	-	-	-
1462C	440	425	420	405	400	380	365	365	325	300	285	260	235	215	190	170	150	125
1462D	590	575	570	555	550	530	515	500	475	450	435	410	385	365	340	320	300	275

## DW-KL 50; SV-EI 60

	80	100	130	150	180	200	250	300	350	400	450	500	550	600	650	700	750	800
1462A	125	120	105	100	80	80	65	50	-	-	-	-	-	-	-	-	-	-
1462B	275	270	255	250	230	230	215	200	175	150	135	110	85	65	-	-	-	-
1462C	425	420	405	400	380	380	365	365	325	300	285	260	235	215	190	170	150	125
1462D	575	570	555	550	530	530	515	500	475	450	435	410	385	365	340	320	300	275

## SV-EI 120

	80	100	130	150	180	200	250	300	350	400	450	500	550	600	650	700	750	800
1462A	80	80	65	65	50	50	-	-	-	-	-	-	-	-	-	-	-	-
1462B	230	230	215	215	200	200	175	150	135	110	85	65	-	-	-	-	-	-
1462C	380	380	365	365	365	365	325	300	285	260	235	215	190	170	150	125	105	80
1462D	530	530	515	515	500	500	475	450	435	410	385	365	340	320	300	275	255	230

## EW-ECO

	80	100	130	150	180	200	250	300	350	400	450	500	550	600	650	700	750	800
1462A	150	150	140	140	125	120	100	80	65	50	-	-	-	-	-	-	-	-
1462B	300	300	290	290	275	270	250	230	215	200	175	150	135	110	85	65	-	-
1462C	450	450	440	440	425	420	400	380	365	365	325	300	285	260	235	215	190	170
1462D	600	600	590	590	575	570	550	530	515	500	475	450	435	410	385	365	340	320



La **norma UNE 13384-2** define dos tipos de chimeneas modulares colectivas **no equilibradas** (sólo evacuación) y **equilibradas** (concéntricas).

Jeremias dispone de varios sistemas para ambos tipos de chimeneas, los cuales tienen aplicaciones y condicionantes diferentes según las exigencias de la norma **UNE 123001 : 2012**.

### SISTEMAS **SEE** Y **SVC** (Sólo evacuación)

- Se pueden conectar un máximo de 10 calderas, hasta 5 plantas conectadas y pudiéndose conectar 2 calderas por planta.
- Cuando existan dos conexiones por planta, éstas deben incorporar un deflector intermedio que impida la entrada de los gases de combustión procedentes de una de las conexiones hacia la otra, reduciendo así mismo las pérdidas de presión por turbulencias.
- Posibilidad de instalación en sobrepresión instalando juntas de silicona en todos los módulos.
- Facilidad de montaje (te, módulo recto y módulo regulable).
- Sistema SEE, fabricado con lana de roca de alta densidad, de 25 mm de espesor y ausencia de puente térmico.

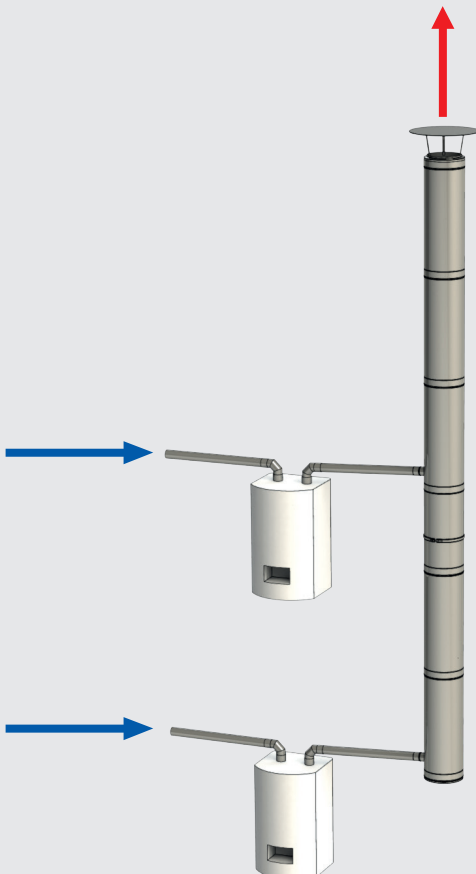

### SISTEMAS **SED** Y **SET** (Concéntricos)

- Se pueden conectar un máximo de 10 calderas, hasta 10 plantas conectadas y pudiéndose conectar dos calderas por planta.
- Cuando existan dos conexiones por planta, éstas deben incorporar un deflector intermedio que impida la entrada de los gases de combustión procedentes de una de las conexiones hacia la otra, reduciendo así mismo las pérdidas de presión por turbulencias.
- En el caso de chimeneas no dimensionadas en sobrepresión, se debe instalar en la base de la chimenea un dispositivo cortatiros. Siendo necesaria una altura mínima de 1 metro entre la conexión de la primera caldera y el cortatiros, en el caso específico de chimeneas que prestan servicio a calderas de condensación.
- Posibilidad de instalación en sobrepresión instalando juntas de silicona en todos los módulos + colector de sobrepresión con calderas de condensación.
- Facilidad de montaje (te, módulo recto y módulo regulable).
- Sistema SET, fabricado con lana de roca de alta densidad, de 25 mm de espesor y ausencia de puente térmico.

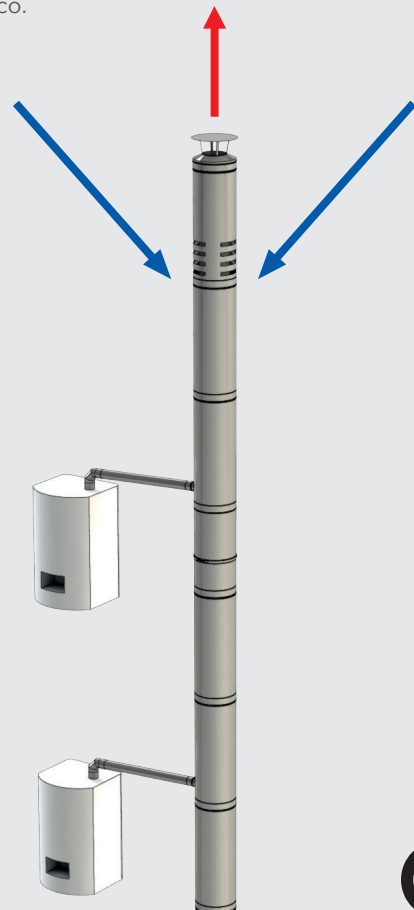

# TABLAS SELECCIÓN RÁPIDA



Condiciones de dimensionamiento en sobrepresión:

El fabricante de la caldera debe indicar que la caldera es apta.

Cada caldera debe incorporar una válvula validada por el fabricante de la caldera.

	DIMENSIONAMIENTO EN DEPRESIÓN (1 metro + 1 codo 87°)					
	SEE		SED		SVC	
ΣPotencias:	ESTANCA	CONDENS.	ESTANCA	CONDENS.	ESTANCA	CONDENS.
0-48	130/180	130/180	130/200	130/200	130	130
49-60	150/200	150/200	130/200	150/230	150	150
61-72	150/200	150/200	150/230	150/230	150	150
73-96	150/200	180/230	150/230	180/280	150	180
97-112	180/230	200/250	180/280	180/280	180	200
113-120	180/230	200/250	180/280	180/280	180	200
121-150	200/250	250/300	200/300	200/300	200	250
151-175	200/250	250/300	200/300	250/400	200	250
176-210	250/300	250/300	250/400	250/400	250	250
210-240	250/300	300/350	250/400	250/400	250	300
241-280	250/300	300/350	250/400	300/450	250	300
281-300	250/300	300/350	250/400	300/450	250	300
301-350	300/350	350/400	300/450	300/450	300	350

	DIMENSIONAMIENTO EN SOBREPRESIÓN (Longitud: 1 metro + 1 codo 87°)		
	SEE	SED	SVC
ΣPotencias:	CONDENS.	CONDENS.	CONDENS.
0-48	80/130	100/150	80
49-60	130/180	110/180	130
61-72	130/180	110/180	130
73-96	130/180	130/200	130
97-112	130/180	130/200	130
113-120	130/180	150/230	130
121-150	150/200	180/280	150
151-175	150/200	180/280	150
176-210	150/200	200/300	150
210-240	180/230	200/300	180
241-280	180/230	250/400	180
281-300	180/230	250/400	180
301-350	180/230	250/400	180

	DIMENSIONAMIENTO EN DEPRESIÓN (3 metro + 1 codo 87°)					
	SEE		SED		SVC	
ΣPotencias:	ESTANCA	CONDENS.	ESTANCA	CONDENS.	ESTANCA	CONDENS.
0-48	130/180	180/230	130/200	130/200	130	180
49-60	150/200	180/230	130/200	150/230	130	180
61-72	150/200	200/250	150/230	150/230	150	200
73-96	180/230	250/300	150/230	180/280	180	250
97-112	180/230	250/300	180/280	180/280	180	250
113-120	180/230	300/350	180/280	200/300	180	300
121-150	200/250	300/350	200/300	250/400	200	300
151-175	200/250	300/350	200/300	250/400	200	300
176-210	250/300	300/350	250/400	250/400	250	300
210-240	250/300	300/350	250/400	250/400	250	300
241-280	250/300	300/350	250/400	300/450	250	300
281-300	300/350	350/400	250/400	300/450	300	350
301-350	300/350	350/400	300/450	300/450	300	350

	DIMENSIONAMIENTO EN SOBREPRESIÓN (3 metro + 1 codo 87°)		
	SEE	SED	SVC
ΣPotencias:	CONDENS.	CONDENS.	CONDENS.
0-48	130/180	100/150	130
49-60	130/180	110/180	130
61-72	130/180	110/180	130
73-96	150/200	130/200	150
97-112	150/200	150/230	150
113-120	180/230	150/230	180
121-150	180/230	180/280	180
151-175	200/250	180/280	200
176-210	200/250	200/300	200
210-240	200/250	250/400	200
241-280	200/250	250/400	200
281-300	200/250	250/400	200
301-350	200/250	250/400	200

Cálculos realizados acorde a la norma UNE-EN 13384-2 con una caldera por planta y con las siguientes hipótesis de cálculo:

- Altura entre plantas y altura sobre última caldera: 3 m.
- Máxima sobrepresión a la salida de la calderas de 50 Pa.
- Tª de humos 60°C/40°C(condensación), 140°C/90°C (estanca).
- Altitud sobre el nivel del mar: 100 m
- Conducto de conexión. Ø80 mm y Ø80/125 mm
- Coeficiente de seguridad: 1,2
- Los cálculos en sobrepresión se han realizado con una válvula antirrevoco integrada en la propia caldera. En caso de no estar integrada la válvula es necesario tener en cuenta la perdida generada por la misma.



# CHIMENEA COLECTIVA

## Sistema SED

Chimenea modular colectiva concéntrica para evacuación de humos y gases de los productos de la combustión de doble pared.

### MATERIAL

Pared Interior: AISI 304 (SED1) / AISI 316L (SED2)  
Pared Exterior: Acero galvanizado / Zincado según diámetros

### ACABADO EXTERIOR

Colores RAL (consultar precios). Sólo disponibles para SED2.  
Incremento 53% para colores RAL.  
Opción exterior AISI 304: +20%

### ESPEORES (mm)

Pared interior: 0,4 - 0,5 (según diámetro)  
Pared exterior: 0,4 - 0,5 (según diámetro)

### DIÁMETROS DISPONIBLES (mm)

Ø80/130 - Ø100/150 - Ø110/180 - Ø130/200 - Ø150/230 - Ø180/280 - Ø200/300 a Ø250/400 - Ø300/450

### SISTEMA DE UNIÓN

Conexión macho-hembra con **abrazadera de unión sencilla**



### APLICACIONES

- Calderas murales estancas y calentadores a gas (SED1)
- Calderas murales de condensación (SED2)



### CARACTERÍSTICAS

- Temperatura de trabajo hasta 200°C
- **Soldadura TIG/LASER** en continuo en todas las piezas
- **Abrazadera de unión INCLUIDA** (excepto terminales)
- Extracción y admisión colectivas (chimeneas equilibradas)
- Hasta 10 calderas conectadas en un máximo de 10 plantas
- Colectores, terminales, soportes y fijaciones a pared en acero inoxidable exterior
- **Junta de condensación incluida para SED2**

### CERTIFICADO CE

0036 CPR 9174 036

### CLASIFICACIONES CE (UNE-EN 1856-1)

T200 - N1 - W - Vm - L20040 - O(00)  
T200 - N1 - W - V2 - L50040 - O(00)  
T200 - P1 - W - Vm - L20040 - O(00)  
T200 - P1 - W - V2 - L50040 - O(00)



Módulo recto 1000mm



Módulo recto 500mm



Módulo recto regulable  
830-1420mm



Codo 45°



Te 87° 2 conexiones a 60 /  
100 a 90°

Ø80	AMI-SED2130080	143€	Ø80	AMI-SED2140080	91€	Ø80	AMI-SED220420080	244€	Ø80	AMI-SED2180080	101€	Ø110	AMI-SED2317E0110	373€
Ø100	AMI-SED2130100	144€	Ø100	AMI-SED2140100	96€	Ø100	AMI-SED220420100	248€	Ø100	AMI-SED2180100	104€	Ø130	AMI-SED2317E0130	378€
Ø110	AMI-SED2130110	146€	Ø110	AMI-SED2140110	96€	Ø110	AMI-SED220420110	254€	Ø110	AMI-SED2180110	104€	Ø150	AMI-SED2317E0150	380€
Ø130	AMI-SED2130130	148€	Ø130	AMI-SED2140130	99€	Ø130	AMI-SED220420130	256€	Ø130	AMI-SED2180130	109€	Ø180	AMI-SED2317E0180	401€
Ø150	AMI-SED2130150	157€	Ø150	AMI-SED2140150	109€	Ø150	AMI-SED220420150	278€	Ø150	AMI-SED2180150	112€	Ø200	AMI-SED2317E0200	430€
Ø180	AMI-SED2130180	166€	Ø180	AMI-SED2140180	121€	Ø180	AMI-SED220420180	305€	Ø180	AMI-SED2180180	115€	Ø250	AMI-SED2317E0250	495€
Ø200	AMI-SED2130200	200€	Ø200	AMI-SED2140200	137€	Ø200	AMI-SED220420200	363€	Ø200	AMI-SED2180200	131€	Ø300	AMI-SED2317E0300	529€
Ø250	AMI-SED2130250	252€	Ø250	AMI-SED2140250	163€	Ø250	AMI-SED220420250	468€	Ø250	AMI-SED2180250	161€			
Ø300	AMI-SED2130300	303€	Ø300	AMI-SED2140300	214€	Ø300	AMI-SED220420300	530€	Ø300	AMI-SED2180300	190€			



Te 87° conexión a 60 / 100



Te 87° conexión a 80 / 110



Te 87° conexión a 80 / 125



Te 87° doble conexión a 60 /  
100



Te 87° doble conexión a  
80 / 110

Ø80	AMI-SED23170080	252€	Ø80	AMI-SED25790080	252€	Ø80	AMI-SED25930080	252€	Ø130	AMI-SED2317D0130	384€	Ø130	AMI-SED2579D0130	384€
Ø100	AMI-SED23170100	264€	Ø100	AMI-SED25790100	256€	Ø100	AMI-SED25930100	261€	Ø150	AMI-SED2317D0150	390€	Ø150	AMI-SED2579D0150	390€
Ø110	AMI-SED23170110	266€	Ø110	AMI-SED25790110	266€	Ø110	AMI-SED25930110	266€	Ø180	AMI-SED2317D0180	404€	Ø180	AMI-SED2579D0180	404€
Ø130	AMI-SED23170130	268€	Ø130	AMI-SED25790130	268€	Ø130	AMI-SED25930130	268€	Ø200	AMI-SED2317D0200	432€	Ø200	AMI-SED2579D0200	432€
Ø150	AMI-SED23170150	272€	Ø150	AMI-SED25790150	272€	Ø150	AMI-SED25930150	272€	Ø250	AMI-SED2317D0250	497€	Ø250	AMI-SED2579D0250	497€
Ø180	AMI-SED23170180	283€	Ø180	AMI-SED25790180	283€	Ø180	AMI-SED25930180	283€	Ø300	AMI-SED2317D0300	529€	Ø300	AMI-SED2579D0300	529€
Ø200	AMI-SED23170200	316€	Ø200	AMI-SED25790200	316€	Ø200	AMI-SED25930200	316€						
Ø250	AMI-SED23170250	374€	Ø250	AMI-SED25790250	374€	Ø250	AMI-SED25930250	374€						
Ø300	AMI-SED23170300	415€	Ø300	AMI-SED25790300	415€	Ø300	AMI-SED25930300	415€						



Te 87° doble conexión a 80 /  
125



Te 87° doble conexión a  
Ø80/125 a 90°

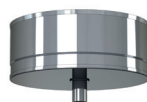

Colector de hollín con  
desagüe

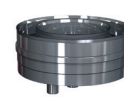

Colector de hollín con  
doble desagüe

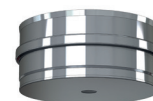

Colector interior para  
sobrepresión (incl. Junta)

Ø130	AMI-SED2593D0130	384€	Ø130	AMI-SED2593E0130	378€	Ø80	680-SED2440080	54€	Ø80	680-SED220500080	106€	Ø80	680-SED24450080	47.13€
Ø150	AMI-SED2593D0150	390€	Ø150	AMI-SED2593E0150	380€	Ø100	680-SED2440100	58€	Ø100	680-SED220500100	110€	Ø100	680-SED24450100	50€
Ø180	AMI-SED2593D0180	404€	Ø180	AMI-SED2593E0180	401€	Ø110	680-SED2440110	61€	Ø110	680-SED220500110	117€	Ø110	680-SED24450110	54€
Ø200	AMI-SED2593D0200	432€	Ø200	AMI-SED2593E0200	430€	Ø130	680-SED2440130	65€	Ø130	680-SED220500130	123€	Ø130	680-SED24450130	54€
Ø250	AMI-SED2593D0250	497€	Ø250	AMI-SED2593E0250	495€	Ø150	680-SED2440150	80€	Ø150	680-SED220500150	144€	Ø150	680-SED24450150	56€
Ø300	AMI-SED2593D0300	529€	Ø300	AMI-SED2593E0300	529€	Ø180	680-SED2440180	88€	Ø180	680-SED220500180	161€	Ø180	680-SED24450180	58€
						Ø200	680-SED2440200	107€	Ø200	680-SED220500200	180€	Ø200	680-SED24450200	65€
						Ø250	680-SED2440250	133€	Ø250	680-SED220500250	241€	Ø250	680-SED24450250	88€
						Ø300	680-SED2440300	220€	Ø300	680-SED220500300	312€	Ø300	680-SED24450300	107€



# CHIMENEA COLECTIVA

## Sistema SED 2 (316/GALVA)



Terminal SED Inox



Terminal SED Inox salida libre



Terminal SED Inox salida libre con rejilla



Soporte de base con doble desagüe

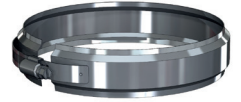

Abrazadera de unión 1.0

Ø80	680-SED29760080	437€	Ø80	680-SED2976A0080	313€	Ø80	680-SED2976B0080	391€	Ø80	680-SED2379B0080	311€	Ø80	665-ZUWA450130	6.52€
Ø100	680-SED29760100	444€	Ø100	680-SED2976A0100	318€	Ø100	680-SED2976B0100	397€	Ø100	680-SED2379B0100	317€	Ø100	665-ZUWA450150	8.15€
Ø110	680-SED29760110	454€	Ø110	680-SED2976A0110	323€	Ø110	680-SED2976B0110	406€	Ø110	680-SED2379B0110	319€	Ø110	665-ZUWA450180	9.75€
Ø130	680-SED29760130	458€	Ø130	680-SED2976A0130	329€	Ø130	680-SED2976B0130	411€	Ø130	680-SED2379B0130	322€	Ø130	665-ZUWA450200	11.38€
Ø150	680-SED29760150	517€	Ø150	680-SED2976A0150	367€	Ø150	680-SED2976B0150	458€	Ø150	680-SED2379B0150	322€	Ø150	665-ZUWA450230	14.65€
Ø180	680-SED29760180	563€	Ø180	680-SED2976A0180	401€	Ø180	680-SED2976B0180	502€	Ø180	680-SED2379B0180	408€	Ø180	665-ZUWA450280	26.04€
Ø200	680-SED29760200	652€	Ø200	680-SED2976A0200	462€	Ø200	680-SED2976B0200	584€	Ø200	680-SED2379B0200	529€	Ø200	665-ZUWA450300	26.04€
Ø250	680-SED29760250	849€	Ø250	680-SED2976A0250	606€	Ø250	680-SED2976B0250	757€	Ø250	680-SED2379B0250	658€	Ø250	665-ZUWA450400	37.43€
Ø300	680-SED29760300	1194€	Ø300	680-SED2976A0300	852€	Ø300	680-SED2976B0300	1067€	Ø300	680-SED2379B0300	819€	Ø300	665-ZUWA450450	42.42€



Abrazadera fijación pared regulable 50-80mm



Base de abrazadera distanciadora



Alas distanciadoras A



Alas distanciadoras B



Alas distanciadoras C

Ø80	665-ZUWA5560130	37.43€	Ø80	665-ZUWA14620130	45.58€	Ø80	665-ZUWA1462A	47.13€	Ø80	665-ZUWA1462B	65€	Ø80	665-ZUWA1462C	81€
Ø100	665-ZUWA5560150	39.04€	Ø100	665-ZUWA14620150	48.72€	Ø100	665-ZUWA1462A	47.13€	Ø100	665-ZUWA1462B	65€	Ø100	665-ZUWA1462C	81€
Ø110	665-ZUWA5560180	39.04€	Ø110	665-ZUWA14620180	52€	Ø110	665-ZUWA1462A	47.13€	Ø110	665-ZUWA1462B	65€	Ø110	665-ZUWA1462C	81€
Ø130	665-ZUWA5560200	45.58€	Ø130	665-ZUWA14620200	58€	Ø130	665-ZUWA1462A	47.13€	Ø130	665-ZUWA1462B	65€	Ø130	665-ZUWA1462C	81€
Ø150	665-ZUWA5560230	52€	Ø150	665-ZUWA14620230	77€	Ø150	665-ZUWA1462A	47.13€	Ø150	665-ZUWA1462B	65€	Ø150	665-ZUWA1462C	81€
Ø180	665-ZUWA5560280	64€	Ø180	665-ZUWA14620280	123€	Ø180	665-ZUWA1462A	47.13€	Ø180	665-ZUWA1462B	65€	Ø180	665-ZUWA1462C	81€
Ø200	665-ZUWA5560300	64€	Ø200	665-ZUWA14620300	138€	Ø200	665-ZUWA1462A	47.13€	Ø200	665-ZUWA1462B	65€	Ø200	665-ZUWA1462C	81€
Ø250	665-ZUWA5560400	88€	Ø250	665-ZUWA14620400	241€	Ø250	665-ZUWA1462A	47.13€	Ø250	665-ZUWA1462B	65€	Ø250	665-ZUWA1462C	81€
Ø300	665-ZUWA5560450	98€	Ø300	665-ZUWA14620450	298€	Ø300	665-ZUWA1462A	47.13€	Ø300	665-ZUWA1462B	65€	Ø300	665-ZUWA1462C	81€



Alas distanciadoras D

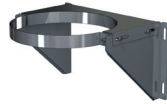

Abrazadera de soporte



Abrazadera con doble pértiga telescópica L=2000mm



Abrazadera forjado inox



Abrazadera forjado isofónica galvanizada

Ø80	665-ZUWA1462D	104€	Ø110	665-ZUWA8580180	145€	Ø80	665-ZUWA1910130	144€	Ø80	665-ZUWA620130	26.04€	Ø80	665-ZUWA62DB0130	21.25€
Ø100	665-ZUWA1462D	104€	Ø130	665-ZUWA8580200	145€	Ø100	665-ZUWA1910150	146€	Ø100	665-ZUWA620150	30.9€	Ø100	665-ZUWA62DB0150	22.2€
Ø110	665-ZUWA1462D	104€	Ø150	665-ZUWA8580230	163€	Ø110	665-ZUWA1910180	156€	Ø110	665-ZUWA620180	42.42€	Ø110	665-ZUWA62DB0180	23.68€
Ø130	665-ZUWA1462D	104€	Ø180	665-ZUWA8580280	202€	Ø130	665-ZUWA1910200	173€	Ø130	665-ZUWA620200	47.13€	Ø130	665-ZUWA62DB0200	24.7€
Ø150	665-ZUWA1462D	104€	Ø200	665-ZUWA8580300	203€	Ø150	665-ZUWA1910230	179€	Ø150	665-ZUWA620230	50€	Ø150	665-ZUWA62DB0230	26.15€
Ø180	665-ZUWA1462D	104€	Ø250	665-ZUWA8580400	270€	Ø180	665-ZUWA1910280	233€	Ø180	665-ZUWA620280	59€	Ø180	665-ZUWA62DB0280	28.63€
Ø200	665-ZUWA1462D	104€	Ø300	665-ZUWA8580450	321€	Ø200	665-ZUWA1910300	233€	Ø200	665-ZUWA620300	59€	Ø200	665-ZUWA62DB0300	32.87€
Ø250	665-ZUWA1462D	104€				Ø250	665-ZUWA1910400	272€	Ø250	665-ZUWA620400	74€	Ø250	665-ZUWA62DB0400	38.4€
Ø300	665-ZUWA1462D	104€				Ø300	665-ZUWA1910450	380€	Ø300	665-ZUWA620450	83€	Ø300	665-ZUWA62DB0450	46.47€

**i** Precio unidad. u/c= unidad caja.

**i** Necesario instalar collarín con el cubreaguas.



Abrazadera vientos



Soporte de techo



Collarín antitormenta

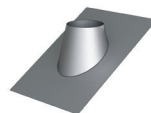

Cubreaguas 25°-45° aluminio

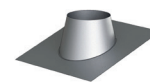

Cubreaguas 5°-25° aluminio

Ø80	665-ZUWA420130	11.38€	Ø80	665-ZUWA9360130	34.15€	Ø80	665-ZUWA3070130	29.27€	Ø80	665-ZUWA939AL0130	219€	Ø80	665-ZUWA938AL0130	206€
Ø100	665-ZUWA420150	14.65€	Ø100	665-ZUWA9360150	40.87€	Ø100	665-ZUWA3070150	34.15€	Ø100	665-ZUWA939AL0150	233€	Ø100	665-ZUWA938AL0150	215€
Ø110	665-ZUWA420180	21.16€	Ø110	665-ZUWA9360180	50€	Ø110	665-ZUWA3070180	40.87€	Ø110	665-ZUWA939AL0180	250€	Ø110	665-ZUWA938AL0180	235€
Ø130	665-ZUWA420200	26.04€	Ø130	665-ZUWA9360200	56€	Ø130	665-ZUWA3070200	47.13€	Ø130	665-ZUWA939AL0200	269€	Ø130	665-ZUWA938AL0200	252€
Ø150	665-ZUWA420230	27.67€	Ø150	665-ZUWA9360230	65€	Ø150	665-ZUWA3070230	52€	Ø150	665-ZUWA939AL0230	288€	Ø150	665-ZUWA938AL0230	261€
Ø180	665-ZUWA420280	32.52€	Ø180	665-ZUWA9360280	83€	Ø180	665-ZUWA3070280	71€	Ø180	665-ZUWA939AL0280	332€	Ø180	665-ZUWA938AL0280	282€
Ø200	665-ZUWA420300	34.15€	Ø200	665-ZUWA9360300	84€	Ø200	665-ZUWA3070300	71€	Ø200	665-ZUWA939AL0300	332€	Ø200	665-ZUWA938AL0300	317€
Ø250	665-ZUWA420400	40.87€	Ø250	665-ZUWA9360400	104€	Ø250	665-ZUWA3070400	83€	Ø250	665-ZUWA939AL0400	433€	Ø250	665-ZUWA938AL0400	390€
Ø300	665-ZUWA420450	56€	Ø300	665-ZUWA9360450	144€	Ø300	665-ZUWA3070450	114€	Ø300	665-ZUWA939AL0450	492€	Ø300	665-ZUWA938AL0450	436€

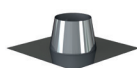

Cubreaguas plano inox

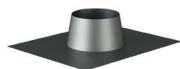

Cubreaguas plomo 0°-5°

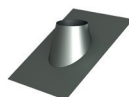

Cubreaguas plomo 25°-45°

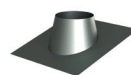

Cubreaguas plomo 5°-25°



Pasamuros

Ø80	665-ZUWA11280130	146€	Ø80	665-ZUWA9370130	205€	Ø80	665-ZUWA9390130	358€	Ø80	665-ZUWA9380130	205€	Ø80	665-ZUWA9870130	39.04€
Ø100	665-ZUWA11280150	150€	Ø100	665-ZUWA9370150	206€	Ø100	665-ZUWA9390150	363€	Ø100	665-ZUWA9380150	206€	Ø100	665-ZUWA9870150	40.87€
Ø110	665-ZUWA11280180	170€	Ø110	665-ZUWA9370180	234€	Ø110	665-ZUWA9390180	379€	Ø110	665-ZUWA9380180	234€	Ø110	665-ZUWA9870180	52€
Ø130	665-ZUWA11280200	185€	Ø130	665-ZUWA9370200	260€	Ø130	665-ZUWA9390200	386€	Ø130	665-ZUWA9380200	260€	Ø130	665-ZUWA9870200	52€
Ø150	665-ZUWA11280230	191€	Ø150	665-ZUWA9370230	269€	Ø150	665-ZUWA9390230	397€	Ø150	665-ZUWA9380230	269€	Ø150	665-ZUWA9870230	64€
Ø180	665-ZUWA11280280	227€	Ø180	665-ZUWA9370280	316€	Ø180	665-ZUWA9390280	413€	Ø180	665-ZUWA9380280	316€	Ø180	665-ZUWA9870280	81€
Ø200	665-ZUWA11280300	233€	Ø200	665-ZUWA9370300	323€	Ø200	665-ZUWA9390300	417€	Ø200	665-ZUWA9380300	323€	Ø200	665-ZUWA9870300	83€
Ø250	665-ZUWA11280400	286€	Ø250	665-ZUWA9370400	396€	Ø250	665-ZUWA9390400	454€	Ø250	665-ZUWA9380400	396€	Ø250	665-ZUWA9870400	121€
Ø300	665-ZUWA11280450	306€	Ø300	665-ZUWA9370450	428€	Ø300	665-ZUWA9390450	541€	Ø300	665-ZUWA9380450	428€	Ø300	665-ZUWA9870450	156€



Junta EPDM (T<120°C)

Ø80	665-ZUWA26C0080	4.88€
Ø100	665-ZUWA26C0100	4.88€
Ø110	665-ZUWA26C0110	4.88€
Ø130	665-ZUWA26C0130	4.88€
Ø150	665-ZUWA26C0150	4.88€
Ø180	665-ZUWA26C0180	6.52€
Ø200	665-ZUWA26C0200	8.15€
Ø250	665-ZUWA26C0250	11.38€
Ø300	665-ZUWA26C0300	14.65€



# CHIMENEA COLECTIVA

## Sistema SEE

**Chimenea modular colectiva para evacuación de humos y gases de los productos de la combustión de doble pared.**

### MATERIAL

Pared Interior: AISI 304 (SEE1) / AISI 316L (SEE2)

Pared Exterior: Acero galvanizado

### ACABADO EXTERIOR

Opción exterior AISI 304: +18% (en piezas comunes con DW-ECO consultar las páginas correspondientes)

### AISLAMIENTO

Lana de roca rígida de alta densidad (120kg/m<sup>3</sup>)

### ESPESORES (mm)

Pared interior: 0,4 - 0,5 (según diámetro)

Aislamiento: 25 mm

Pared exterior: 0,4 - 0,5 (según diámetro)

### DIÁMETROS DISPONIBLES (mm)

Ø80 a Ø300

### SISTEMA DE UNIÓN

Conexión macho-hembra con **abrazadera de unión sencilla**



### APLICACIONES

- Calderas murales estancas y calentadores a gas (SEE1)
- Calderas murales de condensación (SEE2).



### CARACTERÍSTICAS

- Temperatura de trabajo hasta 200°C
- **Soldadura TIG/LASER** en continuo en todas las piezas
- **Abrazadera de unión INCLUIDA** (excepto terminales)
- Extracción colectivas y admisión individual (chimeneas no equilibradas)
- Hasta 10 calderas conectadas en un máximo de 5 plantas
- Instalaciones exteriores y en patinillos compartidos
- Colectores, terminales, soportes y fijaciones siempre en acero inoxidable exterior
- **Junta de condensación incluida para SEE2**

### CERTIFICADO CE

0036 CPR 9174 034

### CLASIFICACIONES CE (UNE-EN 1856-1)

T200 - N1 - W - Vm - L20040 - O(00)

T200 - N1 - W - V2 - L50040 - O(00)

T200 - P1 - W - Vm - L20040 - O(00)

T200 - P1 - W - V2 - L50040 - O(00)



# CHIMENEA COLECTIVA

## Sistema SEE 2 (316/GALVA)



Módulo recto 1000mm



Módulo recto 500mm



Módulo recto regulable  
830-1420mm



Codo 45°



Te 87° con admisión  
Ø60/100

Ø80	AKI-SEE2130080	136€	Ø80	AKI-SEE2140080	96€	Ø80	AKI-SEE220420080	245€	Ø80	AKI-SEE2180080	96€	Ø130	AKI-SEE29730130	234€
Ø130	AKI-SEE2130130	144€	Ø130	AKI-SEE2140130	105€	Ø130	AKI-SEE220420130	255€	Ø130	AKI-SEE2180130	105€	Ø150	AKI-SEE29730150	245€
Ø150	AKI-SEE2130150	162€	Ø150	AKI-SEE2140150	116€	Ø150	AKI-SEE220420150	266€	Ø150	AKI-SEE2180150	115€	Ø180	AKI-SEE29730180	260€
Ø180	AKI-SEE2130180	191€	Ø180	AKI-SEE2140180	139€	Ø180	AKI-SEE220420180	300€	Ø180	AKI-SEE2180180	136€	Ø200	AKI-SEE29730200	304€
Ø200	AKI-SEE2130200	228€	Ø200	AKI-SEE2140200	163€	Ø200	AKI-SEE220420200	363€	Ø200	AKI-SEE2180200	156€	Ø250	AKI-SEE29730250	341€
Ø250	AKI-SEE2130250	286€	Ø250	AKI-SEE2140250	187€	Ø250	AKI-SEE220420250	437€	Ø250	AKI-SEE2180250	183€	Ø300	AKI-SEE29730300	408€
Ø300	AKI-SEE2130300	349€	Ø300	AKI-SEE2140300	232€	Ø300	AKI-SEE220420300	656€	Ø300	AKI-SEE2180300	244€			



Te 87° con admisión  
Ø80/125



Te 87° con doble conexión  
Ø60



Te 87° con doble conexión  
Ø80



Te 87° conexión a Ø60



Te 87° conexión a Ø80

Ø130	AKI-SEE25930130	248€	Ø130	AKI-SEE2317D0130	264€	Ø130	AKI-SEE2578D0130	264€	Ø80	AKI-SEE23170080	188€	Ø80	AKI-SEE25780080	188€
Ø150	AKI-SEE25930150	255€	Ø150	AKI-SEE2317D0150	274€	Ø150	AKI-SEE2578D0150	274€	Ø130	AKI-SEE23170130	202€	Ø130	AKI-SEE25780130	202€
Ø180	AKI-SEE25930180	272€	Ø180	AKI-SEE2317D0180	287€	Ø180	AKI-SEE2578D0180	287€	Ø150	AKI-SEE23170150	207€	Ø150	AKI-SEE25780150	207€
Ø200	AKI-SEE25930200	314€	Ø200	AKI-SEE2317D0200	332€	Ø200	AKI-SEE2578D0200	332€	Ø180	AKI-SEE23170180	222€	Ø180	AKI-SEE25780180	222€
Ø250	AKI-SEE25930250	351€	Ø250	AKI-SEE2317D0250	373€	Ø250	AKI-SEE2578D0250	373€	Ø200	AKI-SEE23170200	269€	Ø200	AKI-SEE25780200	269€
Ø300	AKI-SEE25930300	425€	Ø300	AKI-SEE2317D0300	437€	Ø300	AKI-SEE2578D0300	437€	Ø250	AKI-SEE23170250	304€	Ø250	AKI-SEE25780250	304€
									Ø300	AKI-SEE23170300	373€	Ø300	AKI-SEE25780300	373€

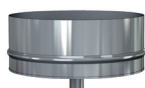

Colector de hollín con  
desagüe

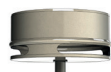

Colector de hollín con  
desagüe y reg. de tiro



Terminal salida libre



Terminal salida libre con  
rejilla (10x10)

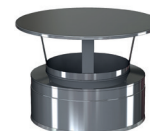

Terminal anti-lluvia

Ø80	909-DWECO440080	52€	Ø80	680-SEE2440080	74€	Ø80	909-DWECO320080	74€	Ø80	909-DWECO32M0080	84€	Ø80	909-DWECO5260080	100€
Ø130	909-DWECO440130	65€	Ø130	680-SEE2440130	78€	Ø130	909-DWECO320130	78€	Ø130	909-DWECO32M0130	90€	Ø130	909-DWECO5260130	109€
Ø150	909-DWECO440150	74€	Ø150	680-SEE2440150	88€	Ø150	909-DWECO320150	90€	Ø150	909-DWECO32M0150	99€	Ø150	909-DWECO5260150	122€
Ø180	909-DWECO440180	78€	Ø180	680-SEE2440180	99€	Ø180	909-DWECO320180	100€	Ø180	909-DWECO32M0180	119€	Ø180	909-DWECO5260180	141€
Ø200	909-DWECO440200	87€	Ø200	680-SEE2440200	118€	Ø200	909-DWECO320200	119€	Ø200	909-DWECO32M0200	138€	Ø200	909-DWECO5260200	163€
Ø250	909-DWECO440250	97€	Ø250	680-SEE2440250	143€	Ø250	909-DWECO320250	138€	Ø250	909-DWECO32M0250	157€	Ø250	909-DWECO5260250	184€
Ø300	909-DWECO440300	119€	Ø300	680-SEE2440300	178€	Ø300	909-DWECO320300	178€	Ø300	909-DWECO32M0300	173€	Ø300	909-DWECO5260300	241€



# CHIMENEA COLECTIVA

## Sistema SEE 2 (316/GALVA)

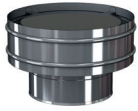

Terminal anti-viento

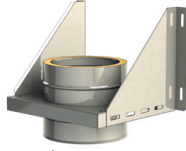

Soporte de carga regulable

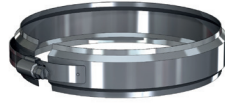

Abrazadera de unión 1.0



Abrazadera fijación pared regulable 50-80mm



Base de abrazadera distanciadora

Ø80	909-DWECO5270080	146€	Ø80	680-SEE23790080	204€	Ø80	665-ZUWA450130	6.52€	Ø80	665-ZUWA5560130	37.43€	Ø80	665-ZUWA14620130	45.58€
Ø130	909-DWECO5270130	157€	Ø130	680-SEE23790130	215€	Ø130	665-ZUWA450180	9.75€	Ø130	665-ZUWA5560180	39.04€	Ø130	665-ZUWA14620180	52€
Ø150	909-DWECO5270150	173€	Ø150	680-SEE23790150	242€	Ø150	665-ZUWA450200	11.38€	Ø150	665-ZUWA5560200	45.58€	Ø150	665-ZUWA14620200	58€
Ø180	909-DWECO5270180	205€	Ø180	680-SEE23790180	283€	Ø180	665-ZUWA450230	14.65€	Ø180	665-ZUWA5560230	52€	Ø180	665-ZUWA14620230	77€
Ø200	909-DWECO5270200	236€	Ø200	680-SEE23790200	327€	Ø200	665-ZUWA450250	21.16€	Ø200	665-ZUWA5560250	61€	Ø200	665-ZUWA14620250	100€
Ø250	909-DWECO5270250	287€	Ø250	680-SEE23790250	398€	Ø250	665-ZUWA450300	26.04€	Ø250	665-ZUWA5560300	64€	Ø250	665-ZUWA14620300	138€
Ø300	909-DWECO5270300	369€	Ø300	680-SEE23790300	516€	Ø300	665-ZUWA450350	29.27€	Ø300	665-ZUWA5560350	67€	Ø300	665-ZUWA14620350	185€



Alas distanciadoras A



Alas distanciadoras B

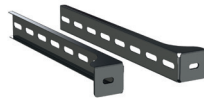

Alas distanciadoras C



Alas distanciadoras D

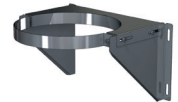

Abrazadera de soporte

Ø80	665-ZUWA1462A	47.13€	Ø80	665-ZUWA1462B	65€	Ø80	665-ZUWA1462C	81€	Ø80	665-ZUWA1462D	104€	Ø130	665-ZUWA8580180	145€
Ø130	665-ZUWA1462A	47.13€	Ø130	665-ZUWA1462B	65€	Ø130	665-ZUWA1462C	81€	Ø130	665-ZUWA1462D	104€	Ø150	665-ZUWA8580200	145€
Ø150	665-ZUWA1462A	47.13€	Ø150	665-ZUWA1462B	65€	Ø150	665-ZUWA1462C	81€	Ø150	665-ZUWA1462D	104€	Ø180	665-ZUWA8580230	163€
Ø180	665-ZUWA1462A	47.13€	Ø180	665-ZUWA1462B	65€	Ø180	665-ZUWA1462C	81€	Ø180	665-ZUWA1462D	104€	Ø200	665-ZUWA8580250	185€
Ø200	665-ZUWA1462A	47.13€	Ø200	665-ZUWA1462B	65€	Ø200	665-ZUWA1462C	81€	Ø200	665-ZUWA1462D	104€	Ø250	665-ZUWA8580300	203€
Ø250	665-ZUWA1462A	47.13€	Ø250	665-ZUWA1462B	65€	Ø250	665-ZUWA1462C	81€	Ø250	665-ZUWA1462D	104€	Ø300	665-ZUWA8580350	221€
Ø300	665-ZUWA1462A	47.13€	Ø300	665-ZUWA1462B	65€	Ø300	665-ZUWA1462C	81€	Ø300	665-ZUWA1462D	104€			



Abrazadera con doble pértiga telescópica L=2000mm

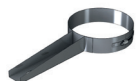

Abrazadera forjado inox



Abrazadera forjado isofónica galvanizada



Abrazadera vientos



Soporte de techo

Ø80	665-ZUWA1910130	144€	Ø80	665-ZUWA620130	26.04€	Ø80	665-ZUWA62DB0130	21.25€	Ø80	665-ZUWA420130	11.38€	Ø80	665-ZUWA9360130	34.15€
Ø130	665-ZUWA1910180	156€	Ø130	665-ZUWA620180	42.42€	Ø130	665-ZUWA62DB0180	23.68€	Ø130	665-ZUWA420180	21.16€	Ø130	665-ZUWA9360180	50€
Ø150	665-ZUWA1910200	173€	Ø150	665-ZUWA620200	47.13€	Ø150	665-ZUWA62DB0200	24.7€	Ø150	665-ZUWA420200	26.04€	Ø150	665-ZUWA9360200	56€
Ø180	665-ZUWA1910230	179€	Ø180	665-ZUWA620230	50€	Ø180	665-ZUWA62DB0230	26.15€	Ø180	665-ZUWA420230	27.67€	Ø180	665-ZUWA9360230	65€
Ø200	665-ZUWA1910250	196€	Ø200	665-ZUWA620250	50€	Ø200	665-ZUWA62DB0250	27.19€	Ø200	665-ZUWA420250	29.27€	Ø200	665-ZUWA9360250	73€
Ø250	665-ZUWA1910300	233€	Ø250	665-ZUWA620300	59€	Ø250	665-ZUWA62DB0300	32.87€	Ø250	665-ZUWA420300	34.15€	Ø250	665-ZUWA9360300	84€
Ø300	665-ZUWA1910350	249€	Ø300	665-ZUWA620350	66€	Ø300	665-ZUWA62DB0350	35.62€	Ø300	665-ZUWA420350	37.43€	Ø300	665-ZUWA9360350	95€

 Precio unidad. u./c= unidad caja.

 Necesario instalar collarín con el cubreaguas.

 Consultar página 91 para ver distancias de separación.



Collarín antitormenta

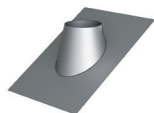

Cubreaguas 25°-45° aluminio

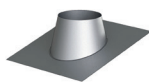

Cubreaguas 5°-25° aluminio

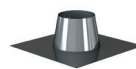

Cubreaguas plano inox

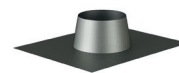

Cubreaguas plomo 0°-5°

Ø80	665-ZUWA3070130	29.27€	Ø80	665-ZUWA939AL0130	219€	Ø80	665-ZUWA938AL0130	206€	Ø80	665-ZUWA11280130	146€	Ø80	665-ZUWA9370130	205€
Ø130	665-ZUWA3070180	40.87€	Ø130	665-ZUWA939AL0180	250€	Ø130	665-ZUWA938AL0180	235€	Ø130	665-ZUWA11280180	170€	Ø130	665-ZUWA9370180	234€
Ø150	665-ZUWA3070200	47.13€	Ø150	665-ZUWA939AL0200	269€	Ø150	665-ZUWA938AL0200	252€	Ø150	665-ZUWA11280200	185€	Ø150	665-ZUWA9370200	260€
Ø180	665-ZUWA3070230	52€	Ø180	665-ZUWA939AL0230	288€	Ø180	665-ZUWA938AL0230	261€	Ø180	665-ZUWA11280230	191€	Ø180	665-ZUWA9370230	269€
Ø200	665-ZUWA3070250	59€	Ø200	665-ZUWA939AL0250	305€	Ø200	665-ZUWA938AL0250	282€	Ø200	665-ZUWA11280250	211€	Ø200	665-ZUWA9370250	294€
Ø250	665-ZUWA3070300	71€	Ø250	665-ZUWA939AL0300	332€	Ø250	665-ZUWA938AL0300	317€	Ø250	665-ZUWA11280300	233€	Ø250	665-ZUWA9370300	323€
Ø300	665-ZUWA3070350	77€	Ø300	665-ZUWA939AL0350	387€	Ø300	665-ZUWA938AL0350	351€	Ø300	665-ZUWA11280350	260€	Ø300	665-ZUWA9370350	361€

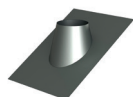

Cubreaguas plomo 25°-45°

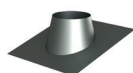

Cubreaguas plomo 5°-25°



Pasamuros



Junta EPDM (T<120°C)

Ø80	665-ZUWA9390130	358€	Ø80	665-ZUWA9380130	205€	Ø80	665-ZUWA9870130	39.04€	Ø80	665-ZUWA26C0080	4.88€
Ø130	665-ZUWA9390180	379€	Ø130	665-ZUWA9380180	234€	Ø130	665-ZUWA9870180	52€	Ø130	665-ZUWA26C0130	4.88€
Ø150	665-ZUWA9390200	386€	Ø150	665-ZUWA9380200	260€	Ø150	665-ZUWA9870200	52€	Ø150	665-ZUWA26C0150	4.88€
Ø180	665-ZUWA9390230	397€	Ø180	665-ZUWA9380230	269€	Ø180	665-ZUWA9870230	64€	Ø180	665-ZUWA26C0180	6.52€
Ø200	665-ZUWA9390250	401€	Ø200	665-ZUWA9380250	294€	Ø200	665-ZUWA9870250	65€	Ø200	665-ZUWA26C0200	8.15€
Ø250	665-ZUWA9390300	417€	Ø250	665-ZUWA9380300	323€	Ø250	665-ZUWA9870300	83€	Ø250	665-ZUWA26C0250	11.38€
Ø300	665-ZUWA9390350	431€	Ø300	665-ZUWA9380350	361€	Ø300	665-ZUWA9870350	95€	Ø300	665-ZUWA26C0300	14.65€



# CHIMENEA COLECTIVA

## Sistema SVC

Chimenea modular colectiva para evacuación de humos y gases de los productos de la combustión de simple pared.

### MATERIAL

AISI 304 (SVC1) / AISI 316L (SVC2)

### ACABADO EXTERIOR

Brillante

### ESPESORES (mm)

0,4

### DIÁMETROS DISPONIBLES (mm)

Ø130 a Ø300

### SISTEMA DE UNIÓN

Conexión macho-hembra con **abrazadera de unión sencilla**



### APLICACIONES

- Calderas murales estancas y calentadores de gas (SVC1)
- Calderas murales de condensación (SVC2)



### CARACTERÍSTICAS

- Instalación sólo por patinillo exclusivo
- **Soldadura TIG/LASER** en continuo en todas las piezas
- Abrazadera de unión **NO INCLUIDA**
- Extracción colectiva y admisión individual (chimeneas no equilibradas)
- Hasta 10 calderas conectadas en un máximo de 5 plantas
- **Junta de condensación incluida para SVC2**

### CERTIFICADO CE

0036 CPR 9174 033

### CLASIFICACIONES CE (UNE-EN 1856-1)

T200 - N1 - W - Vm - L20040 - O(00)

T200 - N1 - W - V2 - L50040 - O(00)

T200 - P1 - W - Vm - L20040 - O(00)

T200 - P1 - W - V2 - L50040 - O(00)



Módulo recto 1000mm



Módulo recto 500mm

Módulo recto regulable  
830-1420mm

Codo 45° condensación

Te 87° con doble conexión  
Ø60

Ø130	680-SVC2130130	74€	Ø130	680-SVC2140130	40.87€	Ø130	680-SVC220420130	168€	Ø130	L02-EWEC18W0130	37.75€	Ø130	680-SVC2317D0130	107€
Ø150	680-SVC2130150	81€	Ø150	680-SVC2140150	44€	Ø150	680-SVC220420150	174€	Ø150	L02-EWEC18W0150	46.23€	Ø150	680-SVC2317D0150	138€
Ø180	680-SVC2130180	96€	Ø180	680-SVC2140180	50€	Ø180	680-SVC220420180	218€	Ø180	L02-EWEC18W0180	58€	Ø180	680-SVC2317D0180	143€
Ø200	680-SVC2130200	109€	Ø200	680-SVC2140200	62€	Ø200	680-SVC220420200	251€	Ø200	L02-EWEC18W0200	66€	Ø200	680-SVC2317D0200	191€
Ø250	680-SVC2130250	141€	Ø250	680-SVC2140250	81€	Ø250	680-SVC220420250	280€	Ø250	L02-EWEC18W0250	77€	Ø250	680-SVC2317D0250	241€
Ø300	680-SVC2130300	172€	Ø300	680-SVC2140300	96€	Ø300	680-SVC220420300	319€	Ø300	L02-EWEC18W0300	113€	Ø300	680-SVC2317D0300	264€

Te 87° con doble conexión  
Ø80

Te 87° conexión a Ø60

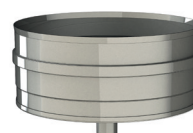

Te 87° conexión a Ø80

Colector de hollín con  
desagüe WColector de hollín con  
desagüe y reg. de tiro

Ø130	680-SVC2578D0130	107€	Ø130	680-SVC23170130	88€	Ø130	680-SVC25780130	88€	Ø130	L02-EWEC44W0130	59€	Ø130	680-SVC2440130	77€
Ø150	680-SVC2578D0150	138€	Ø150	680-SVC23170150	110€	Ø150	680-SVC25780150	110€	Ø150	L02-EWEC44W0150	61€	Ø150	680-SVC2440150	80€
Ø180	680-SVC2578D0180	143€	Ø180	680-SVC23170180	114€	Ø180	680-SVC25780180	114€	Ø180	L02-EWEC44W0180	61€	Ø180	680-SVC2440180	83€
Ø200	680-SVC2578D0200	191€	Ø200	680-SVC23170200	155€	Ø200	680-SVC25780200	155€	Ø200	L02-EWEC44W0200	69€	Ø200	680-SVC2440200	90€
Ø250	680-SVC2578D0250	241€	Ø250	680-SVC23170250	196€	Ø250	680-SVC25780250	196€	Ø250	L02-EWEC44W0250	94€	Ø250	680-SVC2440250	121€
Ø300	680-SVC2578D0300	264€	Ø300	680-SVC23170300	220€	Ø300	680-SVC25780300	220€	Ø300	L02-EWEC44W0300	113€	Ø300	680-SVC2440300	146€

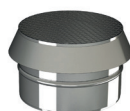

Terminal salida libre

Terminal salida libre con  
rejilla (10x10)

Terminal anti-lluvia



Terminal anti-viento

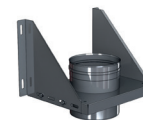

Soporte de carga regulable

Ø130	671-EWEC320130	73€	Ø130	671-EWEC32M0130	81€	Ø130	671-EWEC5260130	99€	Ø130	671-EWEC5270130	143€	Ø130	L02-EWEC3790130	91€
Ø150	671-EWEC320150	90€	Ø150	671-EWEC32M0150	106€	Ø150	671-EWEC5260150	123€	Ø150	671-EWEC5270150	183€	Ø150	L02-EWEC3790150	106€
Ø180	671-EWEC320180	107€	Ø180	671-EWEC32M0180	129€	Ø180	671-EWEC5260180	150€	Ø180	671-EWEC5270180	212€	Ø180	L02-EWEC3790180	132€
Ø200	671-EWEC320200	121€	Ø200	671-EWEC32M0200	151€	Ø200	671-EWEC5260200	170€	Ø200	671-EWEC5270200	247€	Ø200	L02-EWEC3790200	148€
Ø250	671-EWEC320250	150€	Ø250	671-EWEC32M0250	156€	Ø250	671-EWEC5260250	210€	Ø250	671-EWEC5270250	304€	Ø250	L02-EWEC3790250	185€
Ø300	671-EWEC320300	178€	Ø300	671-EWEC32M0300	205€	Ø300	671-EWEC5260300	250€	Ø300	671-EWEC5270300	364€	Ø300	L02-EWEC3790300	222€



# CHIMENEA COLECTIVA

## Sistema SVC2 (316)

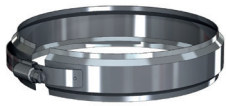

Abrazadera de unión 1.0



Abrazadera fijación pared regulable 50-80mm



Base de abrazadera distanciadora



Alas distanciadoras A



Alas distanciadoras B

Ø130	665-ZUWA450130	6.52€	Ø130	665-ZUWA5560130	37.43€	Ø130	665-ZUWA14620130	45.58€	Ø130	665-ZUWA1462A	47.13€	Ø130	665-ZUWA1462B	65€
Ø150	665-ZUWA450150	8.15€	Ø150	665-ZUWA5560150	39.04€	Ø150	665-ZUWA14620150	48.72€	Ø150	665-ZUWA1462A	47.13€	Ø150	665-ZUWA1462B	65€
Ø180	665-ZUWA450180	9.75€	Ø180	665-ZUWA5560180	39.04€	Ø180	665-ZUWA14620180	52€	Ø180	665-ZUWA1462A	47.13€	Ø180	665-ZUWA1462B	65€
Ø200	665-ZUWA450200	11.38€	Ø200	665-ZUWA5560200	45.58€	Ø200	665-ZUWA14620200	58€	Ø200	665-ZUWA1462A	47.13€	Ø200	665-ZUWA1462B	65€
Ø250	665-ZUWA450250	21.16€	Ø250	665-ZUWA5560250	61€	Ø250	665-ZUWA14620250	100€	Ø250	665-ZUWA1462A	47.13€	Ø250	665-ZUWA1462B	65€
Ø300	665-ZUWA450300	26.04€	Ø300	665-ZUWA5560300	64€	Ø300	665-ZUWA14620300	138€	Ø300	665-ZUWA1462A	47.13€	Ø300	665-ZUWA1462B	65€

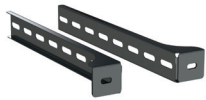

Alas distanciadoras C



Alas distanciadoras D



Abrazadera de soporte



Abrazadera con doble pértiga telescópica L=2000mm



Abrazadera forjado inox

Ø130	665-ZUWA1462C	81€	Ø130	665-ZUWA1462D	104€	Ø180	665-ZUWA8580180	145€	Ø130	665-ZUWA1910130	144€	Ø130	665-ZUWA620130	26.04€
Ø150	665-ZUWA1462C	81€	Ø150	665-ZUWA1462D	104€	Ø200	665-ZUWA8580200	145€	Ø150	665-ZUWA1910150	146€	Ø150	665-ZUWA620150	30.9€
Ø180	665-ZUWA1462C	81€	Ø180	665-ZUWA1462D	104€	Ø250	665-ZUWA8580250	185€	Ø180	665-ZUWA1910180	156€	Ø180	665-ZUWA620180	42.42€
Ø200	665-ZUWA1462C	81€	Ø200	665-ZUWA1462D	104€	Ø300	665-ZUWA8580300	203€	Ø200	665-ZUWA1910200	173€	Ø200	665-ZUWA620200	47.13€
Ø250	665-ZUWA1462C	81€	Ø250	665-ZUWA1462D	104€				Ø250	665-ZUWA1910250	196€	Ø250	665-ZUWA620250	50€
Ø300	665-ZUWA1462C	81€	Ø300	665-ZUWA1462D	104€				Ø300	665-ZUWA1910300	233€	Ø300	665-ZUWA620300	59€



Abrazadera forjado isofónica galvanizada



Abrazadera vientos



Soporte de techo



Collarín antitormenta

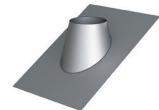

Cubreaguas 25°-45° aluminio

Ø130	665-ZUWA62DB0130	21.25€	Ø130	665-ZUWA420130	11.38€	Ø130	665-ZUWA9360130	34.15€	Ø130	665-ZUWA3070130	29.27€	Ø130	665-ZUWA939AL0130	219€
Ø150	665-ZUWA62DB0150	22.2€	Ø150	665-ZUWA420150	14.65€	Ø150	665-ZUWA9360150	40.87€	Ø150	665-ZUWA3070150	34.15€	Ø150	665-ZUWA939AL0150	233€
Ø180	665-ZUWA62DB0180	23.68€	Ø180	665-ZUWA420180	21.16€	Ø180	665-ZUWA9360180	50€	Ø180	665-ZUWA3070180	40.87€	Ø180	665-ZUWA939AL0180	250€
Ø200	665-ZUWA62DB0200	24.7€	Ø200	665-ZUWA420200	26.04€	Ø200	665-ZUWA9360200	56€	Ø200	665-ZUWA3070200	47.13€	Ø200	665-ZUWA939AL0200	269€
Ø250	665-ZUWA62DB0250	27.19€	Ø250	665-ZUWA420250	29.27€	Ø250	665-ZUWA9360250	73€	Ø250	665-ZUWA3070250	59€	Ø250	665-ZUWA939AL0250	305€
Ø300	665-ZUWA62DB0300	32.87€	Ø300	665-ZUWA420300	34.15€	Ø300	665-ZUWA9360300	84€	Ø300	665-ZUWA3070300	71€	Ø300	665-ZUWA939AL0300	332€

- i Consultar página 91 para ver distancias de separación.
- i Precio unidad. u/c= unidad caja.
- i Necesario instalar collarín con el cubreaguas.

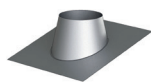
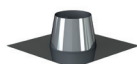
Cubreaguas 5°-25°  
aluminio

Cubreaguas plano inox

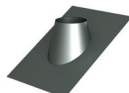

Cubreaguas plomo 25°-45°

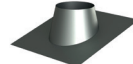

Cubreaguas plomo 5°-25°



Pasamuros

Ø130	665-ZUWA938AL0130	206€	Ø130	665-ZUWA11280130	146€	Ø130	665-ZUWA9390130	358€	Ø130	665-ZUWA9380130	205€	Ø130	665-ZUWA9870130	39.04€
Ø150	665-ZUWA938AL0150	215€	Ø150	665-ZUWA11280150	150€	Ø150	665-ZUWA9390150	363€	Ø150	665-ZUWA9380150	206€	Ø150	665-ZUWA9870150	40.87€
Ø180	665-ZUWA938AL0180	235€	Ø180	665-ZUWA11280180	170€	Ø180	665-ZUWA9390180	379€	Ø180	665-ZUWA9380180	234€	Ø180	665-ZUWA9870180	52€
Ø200	665-ZUWA938AL0200	252€	Ø200	665-ZUWA11280200	185€	Ø200	665-ZUWA9390200	386€	Ø200	665-ZUWA9380200	260€	Ø200	665-ZUWA9870200	52€
Ø250	665-ZUWA938AL0250	282€	Ø250	665-ZUWA11280250	211€	Ø250	665-ZUWA9390250	401€	Ø250	665-ZUWA9380250	294€	Ø250	665-ZUWA9870250	65€
Ø300	665-ZUWA938AL0300	317€	Ø300	665-ZUWA11280300	233€	Ø300	665-ZUWA9390300	417€	Ø300	665-ZUWA9380300	323€	Ø300	665-ZUWA9870300	83€



Junta EPDM (T&lt;120°C)

Ø130	665-ZUWA26C0130	4.88€
Ø150	665-ZUWA26C0150	4.88€
Ø180	665-ZUWA26C0180	6.52€
Ø200	665-ZUWA26C0200	8.15€
Ø250	665-ZUWA26C0250	11.38€
Ø300	665-ZUWA26C0300	14.65€



## CONEXIONES

### Sistema TWIN-PL

Chimenea modular concéntrica fabricada en polipropileno interior y acero pintado exterior para evacuación de humos y gases de combustión y admisión de aire.

#### MATERIAL

Pared Interior: Polipropileno  
Pared Exterior: Acero pintado

#### ACABADO EXTERIOR

Pintado en blanco

#### DIÁMETROS DISPONIBLES (mm)

Ø60/100 - Ø80/125

#### SISTEMA DE UNIÓN

Conexión macho-hembra con **juntas incluidas y abrazadera exterior opcional (no incluida)**



120°C



H1 5000 Pa



#### APLICACIONES

- Calderas de condensación



#### CARACTERÍSTICAS

- Extracción de humos y admisión de aire
- Temperatura de trabajo **hasta 120°C**.
- Opción AISI 304 sin pintar exterior (TWIN-P): + 20%
- Soldadura hot-plate según norma DVS 2207 T11
- Certificado para sobrepresión **hasta 5.000 Pa (H1)**

#### CERTIFICADO CE

0036 CPR 9174 043

#### CLASIFICACIONES CE (UNE-EN 14471)

T120 - H1 - O - W - 2 - O00 - I - E - LO



Módulo recto 2000mm



Módulo recto 1000mm



Módulo recto 500mm



Módulo recto 250mm

Módulo recto regulable  
320-480mm

Ø80	TWPL339080/125	212€	Ø60	TWPL13060/100	85€	Ø60	TWPL14060/100	58€	Ø60	TWPL15060/100	44.31€	Ø60	TWPL50060/100	110€
			Ø80	TWPL13080/125	90€	Ø80	TWPL14080/125	69€	Ø80	TWPL15080/125	54€	Ø80	TWPL50080/125	118€

Módulo condensados  
vertical y horizontal

Codo 30°



Codo 45°



Codo 87°

Codo 87° con puerta de  
inspección

Ø60	TWPL1504060/100	134€	Ø60	TWPL17060/100	76€	Ø60	TWPL18060/100	81€	Ø60	TWPL64060/100	87€	Ø60	TWPL67060/100	181€
Ø80	TWPL1504080/125	136€	Ø80	TWPL17080/125	79€	Ø80	TWPL18080/125	85€	Ø80	TWPL64080/125	95€	Ø80	TWPL67080/125	182€

Elemento corto con punto  
de inspección

Módulo de limpieza



Te 87° con tapa de limpieza

Te 87° con tapa y conexión  
directa a caldera

Terminal horizontal blanco

Ø60	TWPL51060/100	95€	Ø60	TWPL10060/100	111€	Ø60	TWPL11060/100	162€	Ø60	TWPL308060/100	127€	Ø60	TWPL36060/100	160€
Ø80	TWPL51080/125	96€	Ø80	TWPL10080/125	115€	Ø80	TWPL11080/125	163€	Ø80	TWPL308080/125	156€	Ø80	TWPL36080/125	172€



Terminal vertical blanco



Terminal vertical inox.



Terminal vertical negro



Terminal vertical rojo



Adaptador caldera Ø

Ø60	TWPL1942060/100	160€	Ø60	TWPL1941060/100	185€	Ø60	TWPL1944060/100	181€	Ø60	TWPL1943060/100	178€	Ø60	TWPL182060/100	64€
Ø80	TWPL1942080/125	184€	Ø80	TWPL1941080/125	210€	Ø80	TWPL1944080/125	202€	Ø80	TWPL1943080/125	199€	Ø80	TWPL182080/125	66€



# CONEXIONES

## Sistema TWIN-PL



Necesario instalar collarín con el cubreaguas.



Ampliación



Adaptador TW-PL a TW-P

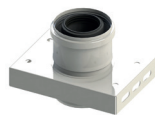

Base soporte intermedio



Abrazadera de unión 1.0

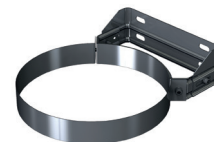

Abrazadera fijación pared regulable 50-80mm

Ø80	TWPLE060/100-080/125	96€
Ø80	TWPLE070/100-080/125	103€
Ø100	TWPLE080/125-100/150	79€

Ø60	TWPL930060/100	47.36€
Ø80	TWPL930080/125	71€

Ø60	TWPL07060/100	66€
Ø80	TWPL07080/125	83€

Ø60	665-ZUWA450100	6.52€
Ø80	665-ZUWA450125	6.52€
Ø100	665-ZUWA450150	8.15€

Ø60	665-ZUWA5560100	34.15€
Ø80	665-ZUWA5560125	37.43€
Ø100	665-ZUWA5560150	39.04€



Abrazadera fijación pared sencilla



Abrazadera de araña



Abrazadera con doble pértiga telescópica L=2000mm



Abrazadera forjado inox



Abrazadera vientos

Ø60	665-ZUWA5350100	14.65€
Ø80	665-ZUWA5350125	14.65€
Ø100	665-ZUWA5350150	19.51€

Ø60	665-ZUWA400100	9.75€
Ø80	665-ZUWA400125	9.75€
Ø100	665-ZUWA400150	9.75€

Ø80	665-ZUWA1910125	144€
Ø100	665-ZUWA1910150	146€

Ø60	665-ZUWA620100	21.16€
Ø80	665-ZUWA620125	26.04€
Ø100	665-ZUWA620150	30.9€

Ø60	665-ZUWA420100	9.75€
Ø80	665-ZUWA420125	11.38€
Ø100	665-ZUWA420150	14.65€



Soporte de techo



Collarín antitormenta

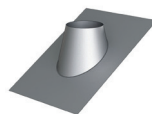

Cubreaguas 25°-45° aluminio

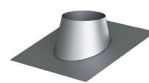

Cubreaguas 5°-25° aluminio

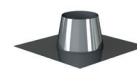

Cubreaguas plano inox

Ø60	665-ZUWA9360100	32.52€
Ø80	665-ZUWA9360125	34.15€
Ø100	665-ZUWA9360150	40.87€

Ø60	665-ZUWA3070100	27.67€
Ø80	665-ZUWA3070125	29.27€
Ø100	665-ZUWA3070150	34.15€

Ø60	665-ZUWA939AL0100	202€
Ø80	665-ZUWA939AL0125	219€
Ø100	665-ZUWA939AL0150	233€

Ø60	665-ZUWA938AL0100	191€
Ø80	665-ZUWA938AL0125	206€
Ø100	665-ZUWA938AL0150	215€

Ø60	665-ZUWA11280100	145€
Ø80	665-ZUWA11280125	146€
Ø100	665-ZUWA11280150	150€

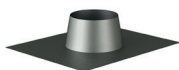

Cubreaguas plomo 0°-5°

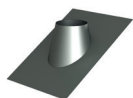

Cubreaguas plomo 25°-45°

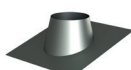

Cubreaguas plomo 5°-25°



Pasamuros



Reducción

Ø60	665-ZUWA9370100	204€
Ø80	665-ZUWA9370125	205€
Ø100	665-ZUWA9370150	206€

Ø60	665-ZUWA9390100	356€
Ø80	665-ZUWA9390125	358€
Ø100	665-ZUWA9390150	363€

Ø60	665-ZUWA9380100	204€
Ø80	665-ZUWA9380125	205€
Ø100	665-ZUWA9380150	206€

Ø60	665-ZUWA9870100	37.43€
Ø80	665-ZUWA9870125	39.04€
Ø100	665-ZUWA9870150	40.87€

Ø60	TWPLR080/125-60/100	111€
Ø60	TWPLR100/150-60/100	147€
Ø80	TWPLR100/150-80/125	118€



## CONEXIONES

Sistema **EW - PPS / EW - PPS - FLEX / CASCADA**

**Conducto de evacuación de humos y gases en simple pared fabricado en polipropileno.**

### MATERIAL

Polipropileno

### ACABADO EXTERIOR

Negro

### ESPESORES (mm)

2,0 mm

### DIÁMETROS DISPONIBLES (mm)

Ø60 a Ø200

### SISTEMA DE UNIÓN

Conexión macho-hembra con **junta interior de EPDM**

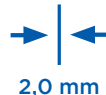

### APLICACIONES

- Calderas de condensación de pequeño tamaño
- **Microgeneración en condensación**
- Instalación individual



### CARACTERÍSTICAS

- Instalación por patinillo interior
- Temperatura de trabajo hasta 120°C
- **Soldadura hot-plate** según norma **DVS 2207 T11**
- Certificado para sobrepresión hasta **5000Pa (H1) para microgeneración**

### CERTIFICADO CE

0036 CPR 9174 043

### CLASIFICACIONES CE (UNE-EN 14471)

T120 - H1 - O - W - 2 - O20 - I - E - L

T120 - P1 - O - W - 2 - O20 - I - E - L



# CONEXIONES

## Sistema EW - PPS



Módulo recto 2000mm



Módulo recto 1000mm



Módulo recto 500mm



Módulo recto 250mm



Módulo de conexión a limitador de temp. L=250mm

Ø60	130-PP339060	39.73€	Ø60	130-PP02060	15.81€	Ø60	130-PP03060	12.65€	Ø60	130-PP04060	11.07€	Ø60	130-PP432A060	152€
Ø80	130-PP339080	42.79€	Ø80	130-PP02080	22.16€	Ø80	130-PP03080	18.98€	Ø80	130-PP04080	14.23€	Ø80	130-PP432A080	160€
Ø100	130-PP339100	62€	Ø100	130-PP02100	34.77€	Ø100	130-PP03100	26.89€	Ø100	130-PP04100	22.16€	Ø100	130-PP432A100	170€
Ø110	130-PP339110	79€	Ø110	130-PP02110	44.31€	Ø110	130-PP03110	34.77€	Ø110	130-PP04110	28.46€	Ø110	130-PP432A110	178€
Ø125	130-PP339125	99€	Ø125	130-PP02125	56€	Ø125	130-PP03125	44.31€	Ø125	130-PP04125	36.39€	Ø125	130-PP432A125	222€
Ø160	130-PP339160	149€	Ø160	130-PP02160	83€	Ø160	130-PP03160	65€	Ø160	130-PP04160	52€	Ø160	130-PP432A160	240€
Ø200	130-PP339200	284€	Ø200	130-PP02200	213€	Ø200	130-PP03200	170€	Ø200	130-PP04200	136€	Ø200	130-PP432A200	261€



Codo 45°



Codo 87° con pie de apoyo y pie deslizante



Codo 87°



Elbow 15°



Elbow 30°

Ø60	130-PP19060	12.65€	Ø60	130-PP06060	41.26€	Ø60	130-PP22060	14.23€	Ø60	130-PP17060	22.16€	Ø60	130-PP18060	12.65€
Ø80	130-PP19080	15.81€	Ø80	130-PP06080	66€	Ø80	130-PP22080	15.81€	Ø80	130-PP17080	31.61€	Ø80	130-PP18080	15.81€
Ø100	130-PP19100	26.89€	Ø100	130-PP06100	88€	Ø100	130-PP22100	17.4€	Ø100	130-PP17100	34.77€	Ø100	130-PP18100	65€
Ø110	130-PP19110	41.26€	Ø110	130-PP06110	111€	Ø110	130-PP22110	42.79€	Ø110	130-PP17110	52€	Ø110	130-PP18110	41.26€
Ø125	130-PP19125	61€	Ø125	130-PP06125	166€	Ø125	130-PP22125	64€	Ø125	130-PP17125	76€	Ø125	130-PP18125	61€
Ø160	130-PP19160	111€	Ø160	130-PP06160	193€	Ø160	130-PP22160	111€	Ø160	130-PP17160	141€	Ø160	130-PP18160	111€
Ø200	130-PP19200	214€	Ø200	130-PP06200	288€	Ø200	130-PP22200	240€	Ø200	130-PP17200	245€	Ø200	130-PP18200	214€



Codo con inspección 90°



Módulo de inspección



Módulo toma de muestras 250mm



Captador de condensados horizontal



Codo 87° con inspección P1

Ø60	130-PP24060	37.96€	Ø60	130-PP30060	34.77€	Ø60	130-PP112060	45.85€	Ø60	130-PP111060	62€	Ø60	130-PP23060	26.89€
Ø80	130-PP24080	45.85€	Ø80	130-PP30080	44.31€	Ø80	130-PP112080	45.85€	Ø80	130-PP111080	76€	Ø80	130-PP23080	36.39€
Ø110	130-PP24110	99€	Ø100	130-PP30100	48.9€	Ø100	130-PP112100	56€	Ø100	130-PP111100	91€	Ø100	130-PP23100	48.9€
Ø125	130-PP24125	228€	Ø110	130-PP30110	71€	Ø110	130-PP112110	81€	Ø110	130-PP111110	125€	Ø110	130-PP23110	99€
			Ø125	130-PP30125	115€	Ø125	130-PP112125	101€	Ø125	130-PP111125	122€	Ø125	130-PP23125	156€
			Ø160	130-PP30160	150€	Ø160	130-PP112160	130€	Ø160	130-PP111160	166€	Ø160	130-PP23160	191€
Ø200	130-PP30200	205€	Ø200	130-PP112200	133€	Ø200	130-PP111200	256€	Ø200	130-PP23200	267€			



Terminal con placa PPS



Terminal placa con collarín inox.



Codo 87° con pie de apoyo y pieza de conexión



Válvula anti retorno con sifón integrado



Abrazadera de araña PPS

Ø60	130-PP837060	56€	Ø60	130-PP342060	130€	Ø60	130-PP1234060	76€	Ø80	130-PP1205080	85€	Ø60	130-PP40060	15.81€
Ø80	130-PP837080	91€	Ø80	130-PP342080	130€	Ø80	130-PP1234080	81€				Ø80	130-PP40080	15.81€
Ø100	130-PP837100	95€	Ø100	130-PP342100	149€	Ø100	130-PP1234100	111€				Ø100	130-PP40100	20.57€
Ø110	130-PP837110	105€	Ø110	130-PP342110	149€	Ø110	130-PP1234110	133€				Ø110	130-PP40110	28.35€
Ø125	130-PP837125	127€	Ø125	130-PP342125	196€							Ø125	130-PP40125	45.85€
Ø160	130-PP837160	220€	Ø160	130-PP342160	282€									
Ø200	130-PP837200	269€	Ø200	130-PP342200	314€									



Abrazadera de araña



Collarín antitormenta



Lubricante 75mL sin cloro



Sifón



Rejilla de protección para ventilación RAL 9016

Ø80	665-ZUWA400080	9.75€	Ø80	665-ZUWA3070080	26.04€	Ø0	130-PPGLEI	14.23€	Ø0	130-PP46	134€	Ø60	130-PP21060	61€
Ø100	665-ZUWA400100	9.75€	Ø100	665-ZUWA3070100	27.67€							Ø80	130-PP21080	65€
Ø125	665-ZUWA400125	9.75€	Ø125	665-ZUWA3070125	29.27€							Ø100	130-PP21100	65€
Ø200	665-ZUWA400200	14.65€	Ø200	665-ZUWA3070200	47.13€							Ø110	130-PP21110	71€
												Ø125	130-PP21125	101€
												Ø160	130-PP21160	110€
												Ø200	130-PP21200	166€



## AMPLIACIÓN



CÓDIGO	Ø A	Ø B	€
130-PPE060080	Ø60	Ø80	<b>34.77€</b>
130-PPE063080	Ø63	Ø80	<b>36.39€</b>
130-PPE070080	Ø70	Ø80	<b>36.39€</b>
130-PPE075080	Ø75	Ø80	<b>36.39€</b>
130-PPE080100	Ø80	Ø100	<b>42.79€</b>
130-PPE080110	Ø80	Ø110	<b>85€</b>
130-PPE080125	Ø80	Ø125	<b>207€</b>
130-PPE100110	Ø100	Ø110	<b>62€</b>
130-PPE100125	Ø100	Ø125	<b>103€</b>
130-PPE100160	Ø100	Ø160	<b>133€</b>
130-PPE110125	Ø110	Ø125	<b>172€</b>
130-PPE125160	Ø125	Ø160	<b>129€</b>
130-PPE160200	Ø160	Ø200	<b>256€</b>

## REDUCCIÓN



CÓDIGO	Ø A	Ø B	€
130-PPR080060	Ø80	Ø60	<b>44.31€</b>
130-PPR100080	Ø100	Ø80	<b>39.73€</b>
130-PPR110080	Ø110	Ø80	<b>39.73€</b>
130-PPR110100	Ø110	Ø100	<b>45.85€</b>
130-PPR125100	Ø125	Ø100	<b>105€</b>
130-PPR125110	Ø125	Ø110	<b>129€</b>
130-PPR130125	Ø130	Ø125	<b>181€</b>
130-PPR150100	Ø150	Ø100	<b>193€</b>
130-PPR150125	Ø150	Ø125	<b>196€</b>
130-PPR160125	Ø160	Ø125	<b>129€</b>

## CONEXIÓN EN Y

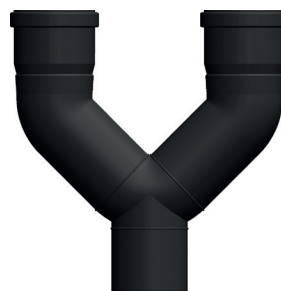

CÓDIGO	Ø A	Ø B	€
130-PPHO080080	Ø80	Ø80	<b>196€</b>
130-PPHO100080	Ø100	Ø80	<b>229€</b>
130-PPHO125100	Ø125	Ø100	<b>327€</b>
130-PPHO125125	Ø125	Ø125	<b>457€</b>
130-PPHO160100	Ø160	Ø100	<b>522€</b>
130-PPHO160110	Ø160	Ø110	<b>688€</b>
130-PPHO160125	Ø160	Ø125	<b>586€</b>
130-PPHO200160	Ø200	Ø160	<b>649€</b>
130-PPHO250160	Ø250	Ø160	<b>823€</b>

## AMPLIACIÓN EXCÉNTRICA



CÓDIGO	Ø A	Ø B	€
130-PPE060080EX	Ø60	Ø80	<b>39.73€</b>
130-PPE063080EX	Ø63	Ø80	<b>65€</b>
130-PPE070080EX	Ø70	Ø80	<b>65€</b>
130-PPE075080EX	Ø75	Ø80	<b>65€</b>
130-PPE080100EX	Ø80	Ø100	<b>79€</b>
130-PPE080110EX	Ø80	Ø110	<b>111€</b>
130-PPE080125EX	Ø80	Ø125	<b>129€</b>
130-PPE100110EX	Ø100	Ø110	<b>111€</b>
130-PPE100125EX	Ø100	Ø125	<b>103€</b>
130-PPE100160EX	Ø100	Ø160	<b>234€</b>
130-PPE110125EX	Ø110	Ø125	<b>99€</b>
130-PPE110160EX	Ø110	Ø160	<b>173€</b>
130-PPE125160EX	Ø125	Ø160	<b>129€</b>
130-PPE125200EX	Ø125	Ø200	<b>202€</b>
130-PPE130160EX	Ø130	Ø160	<b>232€</b>
130-PPE150160EX	Ø150	Ø160	<b>221€</b>
130-PPE160200EX	Ø160	Ø200	<b>150€</b>
130-PPE180200EX	Ø180	Ø200	<b>256€</b>



## CONEXIONES

### Sistema EW - PPS - FLEX



Tubo recto flexible 10 m



Tubo recto flexible 12,5 m



Tubo recto flexible 15 m



Tubo recto flexible 20 m



Tubo recto flexible 30 m

Ø60	PPFLEX02060/10	294€	Ø60	PPFLEX02060/125	357€	Ø60	PPFLEX02060/15	425€	Ø80	PPFLEX02080/20	1060€	Ø125	PPFLEX02125/30	3238€
Ø80	PPFLEX02080/10	421€	Ø80	PPFLEX02080/125	520€	Ø80	PPFLEX02080/15	620€	Ø125	PPFLEX02125/20	2039€	Ø160	PPFLEX02160/30	4475€
Ø100	PPFLEX02100/10	616€	Ø100	PPFLEX02100/125	765€	Ø100	PPFLEX02100/15	914€	Ø160	PPFLEX02160/20	2773€			
						Ø125	PPFLEX02125/15	1791€						
						Ø160	PPFLEX02160/15	1943€						



Tubo recto flexible 50 m



Tubo recto flexible 75 m



Codo 87° con pie de apoyo y pie deslizante



Módulo de inspección



Terminal con placa PPS

Ø80	PPFLEX02080/50	1598€	Ø60	PPFLEX02060/75	1959€	Ø60	130-PP06060	41.26€	Ø60	PPFLEX30060	90€	Ø60	130-PP837060	56€
Ø100	PPFLEX02100/50	2812€				Ø80	130-PP06080	66€	Ø80	PPFLEX30080	104€	Ø80	130-PP837080	91€
						Ø100	130-PP06100	88€	Ø100	PPFLEX30100	143€	Ø100	130-PP837100	95€
						Ø125	130-PP06125	166€	Ø125	PPFLEX30125	354€	Ø125	130-PP837125	127€
						Ø160	130-PP06160	193€	Ø160	PPFLEX30160	404€	Ø160	130-PP837160	220€



Terminal placa con collarín inox.



Abrazadera centradora (pack 4 unidades)



Collarín antitormenta



Manguito de unión PPS Flex-PPs Flex



Kit para flexible suspendido

Ø60	130-PP342060	130€	Ø60	PPFLEX41060	66€	Ø80	665-ZUWA3070080	26.04€	Ø60	PPFLEX07060	59€	Ø60	PPFLEX804060	47.36€
Ø80	130-PP342080	130€	Ø80	PPFLEX41080	69€	Ø100	665-ZUWA3070100	27.67€	Ø80	PPFLEX07080	85€	Ø80	PPFLEX804080	47.36€
Ø100	130-PP342100	149€	Ø100	PPFLEX41100	71€	Ø125	665-ZUWA3070125	29.27€	Ø100	PPFLEX07100	111€	Ø100	PPFLEX804100	61€
Ø125	130-PP342125	196€							Ø125	PPFLEX07125	213€			
Ø160	130-PP342160	282€							Ø160	PPFLEX07160	245€			



## CONEXIONES

### Sistema EW - PPS - FLEX / CASCADA PPS



Kit de montaje 1  
(abrazadera y pasador)



Abrazadera centradora (1  
unidad)

Ø60	PPFLEX09060	25.33€	Ø80	PPFLEX40080	31.61€
Ø80	PPFLEX09080	28.46€	Ø100	PPFLEX40100	31.61€
Ø100	PPFLEX09100	37.96€	Ø125	PPFLEX40125	45.85€
Ø125	PPFLEX09125	56€	Ø160	PPFLEX40160	45.85€
Ø160	PPFLEX09160	62€			

## KIT BÁSICO CASCADA

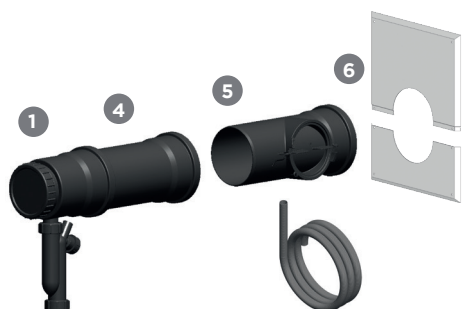

El set básico se compone de:

- (1) Colector con drenaje
- (2) Manguera de desagüe 2 m
- (3) Sifón
- (4) Tramo recto 315 mm.
- (5) Tramo con apertura de inspección
- (6) Embellecedor

CÓDIGO	Ø A	€
130-PPKAS080/B-SET	Ø80	244€
130-PPKAS100/B-SET	Ø100	270€
130-PPKAS110/B-SET	Ø110	298€
130-PPKAS125/B-SET	Ø125	378€
130-PPKAS160/B-SET	Ø160	466€
130-PPKAS200/B-SET	Ø200	581€

## KIT CONEXIÓN CASCADA



El set de ampliación se compone de:

- (1) Te de 42°
- (2) Tramo recto de 1.015 mm
- (3) Codo de 87° con apertura de inspección
- (4) Tramo recto de 315 mm

CÓDIGO	Ø A	Ø B	€
130-PPKAS080080E-SET	Ø80	Ø80	206€
130-PPKAS100080E-SET	Ø100	Ø80	412€
130-PPKAS125080E-SET	Ø125	Ø80	288€
130-PPKAS125100E-SET	Ø125	Ø100	313€
130-PPKAS160100E-SET	Ø160	Ø100	412€
130-PPKAS200100E-SET	Ø200	Ø100	494€
130-PPKAS250100E-SET	Ø250	Ø100	573€
130-PPKAS250200E-SET	Ø250	Ø200	975€

## MONTAJE DEL TERMINAL CON PLACA DE ESTANQUEIDAD

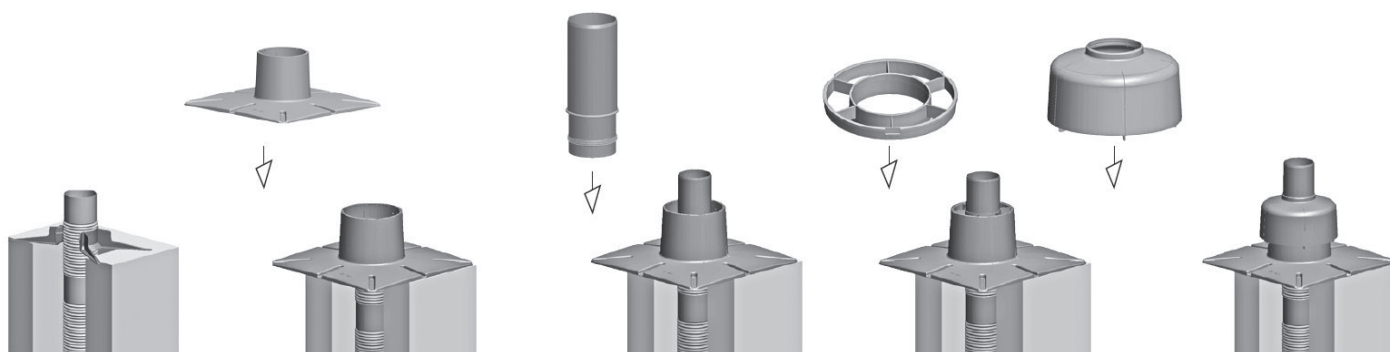

# TERMINALES

**jeremias**

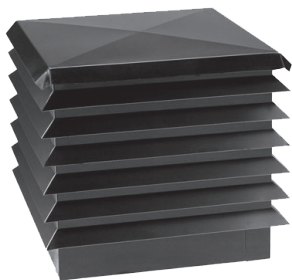

TERMINAL **HYBRID** (aluminio)

Uniones realizadas con remaches de bola y de flor de 5 mm. Altura total de 500 mm con 150 mm de faldón y lamas internas con perfil en L separadas 60 mm entre ellas. Opción pintado, colores RAL.

TERMINAL **FORCE** (aluminio)

Uniones realizadas con remaches de bola y de flor de 5 mm. Altura total de 500 mm con 150 mm de faldón y lamas internas con perfil en L separadas 60 mm entre ellas. Opción pintado, colores RAL.

TERMINAL **JAIL** (aluminio)

Uniones realizadas con puntos de embutición expansivos. Altura total de 500 mm con 100 mm de faldón y lamas externas con perfil en L cerrado separadas 60 mm entre ellas. Opción pintado, colores RAL.



TERMINAL **HURRICANE\***

Terminal dinámico para evacuación de humos, con doble rodamiento en cada lado del eje giratorio fijo. El único homologado para extracción de productos de la combustión de todo tipo de combustibles. Resistente al viento hasta 100km/h. Válido también para combustibles sólidos (hollines).

Ø130	HURR130	542€
Ø150	HURR150	542€
Ø180	HURR180	701€
Ø200	HURR200	701€
Ø250	HURR250	701€
Ø300	HURR300	848€

TERMINAL **TWISTER**

Remate giratorio fabricado en acero inoxidable (AISI 304) con efecto antirretorno incluso en parado, con eje central fijo.

Ø100	TWIST.100	215€
Ø125	TWIST.125	230€
Ø130	TWIST.130	230€

Ø150	TWIST.150	230€
Ø180	TWIST.180	262€
Ø200	TWIST.200	262€
Ø250	TWIST.250	331€
Ø300	TWIST.300	331€
Ø350	TWIST.350	579€



Los terminales Hurricane necesitan un adaptador específico para conectar a cada sistema de chimenea. Consultar la página del sistema al que se desea conectar para ver el código y precio del adaptador correspondiente.

## ¿Necesitas asesoramiento técnico?

Solicita asesoramiento y/o presupuesto personalizado sin compromiso.

**946 301 010**  
**info@jeremias.es**







# Resistencia al fuego

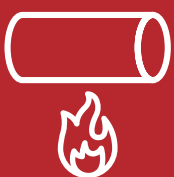

## Índice

DW-FT EI30	122
SV-FT EI60	130
SV-FT EI120/240	138

# 119

**JEREMIAS** dispone de una gama completa de conductos modulares metálicos para su uso en instalaciones de ventilación que cumplen con todos los requisitos de resistencia al fuego indicados en la reglamentación vigente.



## APLICACIONES

- Extracción de campanas de cocina industriales
- Ventilación de garajes subterráneos
- Sectorización de incendios
- Extracción de calderas
- Grupos electrógenos
- Climatización
- Extracción de químicos (no clorados)

Sistema **DW-FT EI30** Con **30 minutos de resistencia al fuego**, es la gama diseñada para las instalaciones de extracción de campanas de cocinas industriales. Dispone además de los módulos con registros de limpieza testados exigidos en las instalaciones.

Sistema **SV-FT 60** Con **60 minutos de resistencia al fuego**, es la gama diseñada para las instalaciones de ventilación de garajes subterráneos. Este conducto es el adecuado para la parte de la instalación que va desde el extractor hasta el exterior del edificio a través de diferentes sectores del mismo.

Sistema **SV-FT 120-240** Con **120 minutos de resistencia al fuego interior y 240 minutos al fuego exterior**, es la gama para instalaciones de ventilación en sectores de alto riesgo de incendio, de tal modo que el conducto tenga la misma clasificación que los muros y techos que atraviesa.



Se recomienda el uso de Tés de 135 o para mejorar el rendimiento de los extractores.

## Pesos por metro lineal

Pesos aproximados por metro lineal de chimenea en cada modelo y diámetro, así como las alturas máximas entre soportes de carga en función del diámetro para instalación vertical. En la base de la vertical es necesaria la colocación de un soporte de carga (recomendablemente por encima de la te de conexión).

En instalación horizontal se recomienda que la distancia entre abrazaderas de fijación sea de 2m. En instalación vertical la distancia entre abrazaderas de fijación pared debe ser de 4m como máximo.

La máxima altura en voladizo por encima de la última conexión es de 3m. (Dependiendo del diámetro. Consultar DOP)



## PESOS (kg)

	DW-FT EI30	SV-FT EI60	SV-FT EI120-240
Ø 130	4,9	7,7	14,7
Ø 150	5,5	8,5	16,0
Ø 180	6,4	9,8	17,9
Ø 200	7	10,7	19,2
Ø 250	8,6	12,8	22,4
Ø 300	10,2	14,9	25,6
Ø 350	13,7	19,2	31,2
Ø 400	15,6	21,6	34,7
Ø 450	17,4	24,0	38,2
Ø 500	19,2	26,4	41,6
Ø 550	21,1	28,8	45,1
Ø 600	26,2	34,7	52,3
Ø 650	30,7	37,3	56,0
Ø 700	32,9	40,0	59,8
Ø 750	35,2	42,7	63,5
Ø 800	37,4	45,3	67,2



## Conductos con Resistencia al Fuego

1. Terminal salida cónica (DWFT 32C)
2. Módulo recto 1.000 mm (DWFT 13)
3. Abrazadera fijación pared fija (ZUWA556F)
4. Soporte de carga regulable (DWFT 379)
5. Te 135° (DWFT 12)
6. Colector de hollín con desagüe aislado (DWFT 1460)
7. Codo 45° (DWFT 18)
8. Módulo de inspección con tapa (DWFT 549)
9. Codo 90° (DWFT 60)
10. Adaptador plano salida (DWFT 2030)

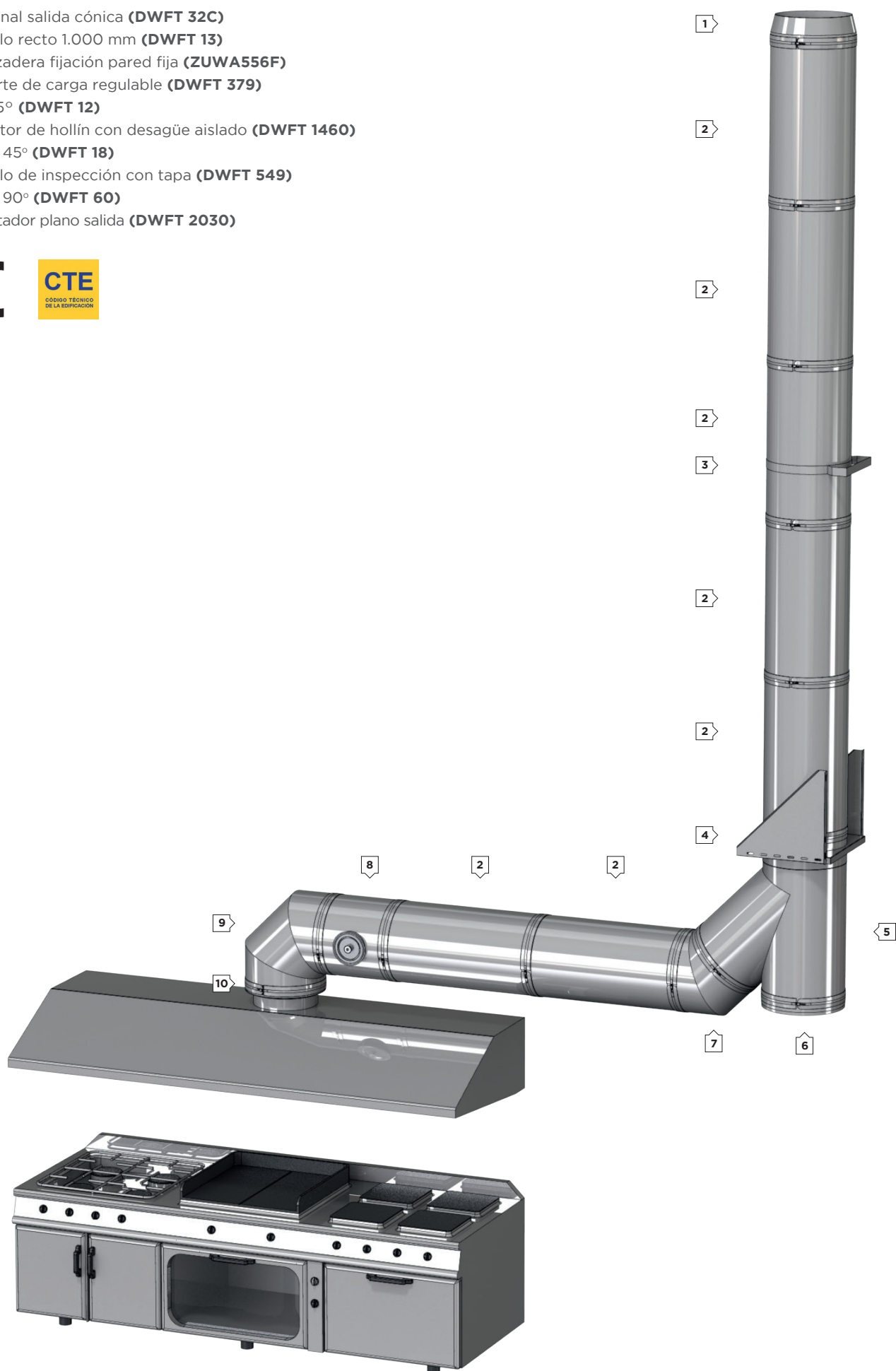

## Conducto modular metálico con resistencia al fuego EI30 para extracción de campanas de cocina industriales de doble pared fabricada en acero inoxidable interior y exterior.

### MATERIAL

Pared Interior: Acero inoxidable  
Pared Exterior: Acero inoxidable

### ACABADO EXTERIOR

Brillante  
Colores RAL (consulta página 14 para acabados especiales)  
Pared exterior galvanizada/zincada: -15% (solo tramos rectos y codos)  
**Acabado galvanizado/zinc no apto para instalación exterior.**

### AISLAMIENTO

Lana de roca rígida de alta densidad (120kg/m<sup>3</sup>). Posibilidad de fabricación con fibra cerámica como aislamiento alternativo (consultar).

### ESPESORES (mm)

Pared interior: 0,4 - 0,5 - 0,6 - 0,8 (según diámetro)  
Aislamiento: 25 mm (32 mm a partir de Ø650 mm)  
Pared exterior: 0,4 - 0,5 - 0,6 - 0,8 (según diámetro)

### DIÁMETROS DISPONIBLES (mm)

Ø130 a Ø800

### SISTEMA DE UNIÓN

Conexión macho-hembra con abrazadera de unión ancha (2.0)



120°C



H1 5000 Pa



25 mm

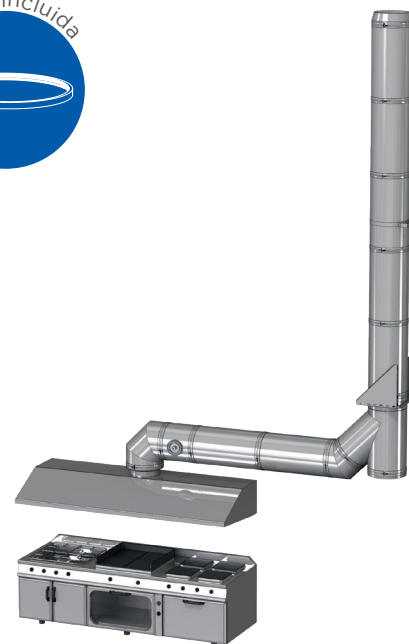

### APLICACIONES

- Extracción de campanas de cocina
- Sectorización de zonas de incendio de bajo riesgo
- Climatización
- Extracción de productos químicos



### CARACTERÍSTICAS

- **Estanqueidad clase C según norma UNE-EN 12237** con la instalación de juntas de estanqueidad
- **Clasificación H1** (hasta 5.000 Pa) de estanqueidad según **UNE-EN 1856-1**
- **Junta de estanqueidad incluida.**
- **Soldadura TIG/LASER** en continuo en todas las piezas
- **Abrazadera de unión incluida (excepto terminales)**
- Posibilidad de **corte de módulos rectos a medida en obra** (ver instrucciones de corte página 53)
- **Sin necesidad de aplicación de sellantes en obra por parte del instalador.**

### CLASIFICACIONES EI (UNE-EN 13501-3)

EI 30 (ve i → o)  
EI 30 (ho i → o)  
EI 60 (ve o → i) S  
EI 30 (ho o → i) S



# Sistema DW - FT EI30



Módulo recto 1000mm



Módulo recto 500mm

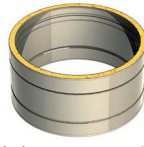

Módulo recto 250mm



Módulo recto regulable  
400-560mm



Módulo recto regulable  
560-920mm

130	BK2-DWFT130130	152€	130	BK2-DWFT140130	113€	130	BK2-DWFT150130	83€	130	BK2-DWFT5440130	152€	130	BK2-DWFT5450130	221€
150	BK2-DWFT130150	186€	150	BK2-DWFT140150	128€	150	BK2-DWFT150150	96€	150	BK2-DWFT5440150	172€	150	BK2-DWFT5450150	249€
180	BK2-DWFT130180	212€	180	BK2-DWFT140180	147€	180	BK2-DWFT150180	107€	180	BK2-DWFT5440180	199€	180	BK2-DWFT5450180	274€
200	BK2-DWFT130200	249€	200	BK2-DWFT140200	170€	200	BK2-DWFT150200	129€	200	BK2-DWFT5440200	231€	200	BK2-DWFT5450200	308€
250	BK2-DWFT130250	302€	250	BK2-DWFT140250	197€	250	BK2-DWFT150250	144€	250	BK2-DWFT5440250	275€	250	BK2-DWFT5450250	372€
300	BK2-DWFT130300	375€	300	BK2-DWFT140300	252€	300	BK2-DWFT150300	185€	300	BK2-DWFT5440300	344€	300	BK2-DWFT5450300	523€
350	BK2-DWFT130350	466€	350	BK2-DWFT140350	317€	350	BK2-DWFT150350	246€	350	BK2-DWFT5440350	443€	350	BK2-DWFT5450350	657€
400	BK2-DWFT130400	519€	400	BK2-DWFT140400	375€	400	BK2-DWFT150400	295€	400	BK2-DWFT5440400	529€	400	BK2-DWFT5450400	755€
450	BK2-DWFT130450	557€	450	BK2-DWFT140450	389€	450	BK2-DWFT150450	324€	450	BK2-DWFT5440450	577€	450	BK2-DWFT5450450	780€
500	BK2-DWFT130500	599€	500	BK2-DWFT140500	403€	500	BK2-DWFT150500	357€	500	BK2-DWFT5440500	608€	500	BK2-DWFT5450500	817€
550	BK2-DWFT130550	683€	550	BK2-DWFT140550	521€	550	BK2-DWFT150550	402€	550	BK2-DWFT5440550	646€	550	BK2-DWFT5450550	843€
600	BK2-DWFT130600	838€	600	BK2-DWFT140600	621€	600	BK2-DWFT150600	509€	600	BK2-DWFT5440600	794€	600	BK2-DWFT5450600	1130€
650	BK2-DWFT130650	1042€	650	BK2-DWFT140650	774€	650	BK2-DWFT150650	637€	650	BK2-DWFT5440650	991€	650	BK2-DWFT5450650	1412€
700	BK2-DWFT130700	1100€	700	BK2-DWFT140700	812€	700	BK2-DWFT150700	667€	700	BK2-DWFT5440700	1040€	700	BK2-DWFT5450700	1488€
750	BK2-DWFT130750	1169€	750	BK2-DWFT140750	869€	750	BK2-DWFT150750	712€	750	BK2-DWFT5440750	1106€	750	BK2-DWFT5450750	1580€
800	BK2-DWFT130800	1308€	800	BK2-DWFT140800	964€	800	BK2-DWFT150800	794€	800	BK2-DWFT5440800	1233€	800	BK2-DWFT5450800	1764€



Codo 15°

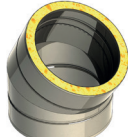

Codo 30°

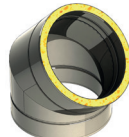

Codo 45°

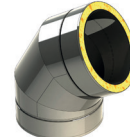

Codo 60°

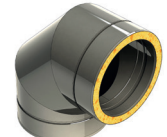

Codo 90°

130	BK2-DWFT160130	112€	130	BK2-DWFT170130	112€	130	BK2-DWFT180130	113€	130	BK2-DWFT840130	137€	130	BK2-DWFT600130	158€
150	BK2-DWFT160150	129€	150	BK2-DWFT170150	129€	150	BK2-DWFT180150	128€	150	BK2-DWFT840150	152€	150	BK2-DWFT600150	176€
180	BK2-DWFT160180	147€	180	BK2-DWFT170180	147€	180	BK2-DWFT180180	147€	180	BK2-DWFT840180	177€	180	BK2-DWFT600180	204€
200	BK2-DWFT160200	171€	200	BK2-DWFT170200	171€	200	BK2-DWFT180200	170€	200	BK2-DWFT840200	206€	200	BK2-DWFT600200	237€
250	BK2-DWFT160250	197€	250	BK2-DWFT170250	197€	250	BK2-DWFT180250	197€	250	BK2-DWFT840250	237€	250	BK2-DWFT600250	281€
300	BK2-DWFT160300	238€	300	BK2-DWFT170300	238€	300	BK2-DWFT180300	238€	300	BK2-DWFT840300	305€	300	BK2-DWFT600300	366€
350	BK2-DWFT160350	321€	350	BK2-DWFT170350	321€	350	BK2-DWFT180350	321€	350	BK2-DWFT840350	388€	350	BK2-DWFT600350	458€
400	BK2-DWFT160400	401€	400	BK2-DWFT170400	401€	400	BK2-DWFT180400	401€				400	BK2-DWFT600400	576€
450	BK2-DWFT160450	571€	450	BK2-DWFT170450	571€	450	BK2-DWFT180450	571€				450	BK2-DWFT600450	713€
500	BK2-DWFT160500	642€	500	BK2-DWFT170500	642€	500	BK2-DWFT180500	642€						
550	BK2-DWFT160550	888€	550	BK2-DWFT170550	888€	550	BK2-DWFT180550	888€						
600	BK2-DWFT160600	1051€	600	BK2-DWFT170600	1051€	600	BK2-DWFT180600	1051€						
650	BK2-DWFT160650	1307€	650	BK2-DWFT170650	1307€	650	BK2-DWFT180650	1308€						
700	BK2-DWFT160700	1378€	700	BK2-DWFT170700	1378€	700	BK2-DWFT180700	1377€						
750	BK2-DWFT160750	1463€	750	BK2-DWFT170750	1463€	750	BK2-DWFT180750	1463€						
800	BK2-DWFT160800	1636€	800	BK2-DWFT170800	1636€	800	BK2-DWFT180800	1636€						



Te 90°



Te 135°

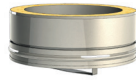

Colector de hollín aislado



Colector de hollín con  
desagüe aislado



Codo 90° con tapa de  
inspección P1

130	BK2-DWFT3170130	222€	130	BK2-DWFT120130	304€	130	650-DWFT20330130	78€	130	650-DWFT14600130	95€	130	BK2-DWFT19AL0130	298€
150	BK2-DWFT3170150	243€	150	BK2-DWFT120150	331€	150	650-DWFT20330150	84€	150	650-DWFT14600150	100€	150	BK2-DWFT19AL0150	337€
180	BK2-DWFT3170180	284€	180	BK2-DWFT120180	361€	180	650-DWFT20330180	98€	180	650-DWFT14600180	109€	180	BK2-DWFT19AL0180	367€
200	BK2-DWFT3170200	335€	200	BK2-DWFT120200	420€	200	650-DWFT20330200	111€	200	650-DWFT14600200	123€	200	BK2-DWFT19AL0200	398€
250	BK2-DWFT3170250	425€	250	BK2-DWFT120250	672€	250	650-DWFT20330250	117€	250	650-DWFT14600250	137€	250	BK2-DWFT19AL0250	386€
300	BK2-DWFT3170300	550€	300	BK2-DWFT120300	766€	300	650-DWFT20330300	138€	300	650-DWFT14600300	210€	300	BK2-DWFT19AL0300	454€
350	BK2-DWFT3170350	683€	350	BK2-DWFT120350	926€	350	650-DWFT20330350	151€	350	650-DWFT14600350	241€	350	BK2-DWFT19AL0350	706€
400	BK2-DWFT3170400	850€	400	BK2-DWFT120400	1255€	400	650-DWFT20330400	178€	400	650-DWFT14600400	252€			
450	BK2-DWFT3170450	962€	450	BK2-DWFT120450	1401€	450	650-DWFT20330450	199€	450	650-DWFT14600450	297€			
500	BK2-DWFT3170500	1137€	500	BK2-DWFT120500	1437€	500	650-DWFT20330500	295€	500	650-DWFT14600500	365€			
550	BK2-DWFT3170550	1236€	550	BK2-DWFT120550	2854€	550	650-DWFT20330550	363€	550	650-DWFT14600550	438€			
600	BK2-DWFT3170600	1515€	600	BK2-DWFT120600	3014€	600	650-DWFT20330600	338€	600	650-DWFT14600600	454€			
650	BK2-DWFT3170650	1890€	650	BK2-DWFT120650	3765€	650	650-DWFT20330650	387€	650	650-DWFT14600650	494€			
700	BK2-DWFT3170700	1990€	700	BK2-DWFT120700	3956€	700	650-DWFT20330700	415€	700	650-DWFT14600700	529€			
750	BK2-DWFT3170750	2109€	750	BK2-DWFT120750	4195€	750	650-DWFT20330750	444€	750	650-DWFT14600750	567€			
800	BK2-DWFT3170800	2362€	800	BK2-DWFT120800	4698€	800	650-DWFT20330800	472€	800	650-DWFT14600800	603€			



Módulo de inspección con  
tapa 200 Pa (P1)

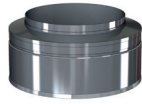

Terminal salida libre

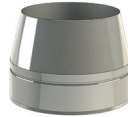

Terminal salida cónica



Terminal anti-lluvia

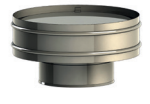

Terminal anti-viento

130	BK2-DWFT5490130	246€	130	BK2-DWFT320130	71€	130	BK2-DWFT32C0130	81€	130	BK2-DWFT5260130	100€	130	BK2-DWFT5270130	138€
150	BK2-DWFT5490150	256€	150	BK2-DWFT320150	81€	150	BK2-DWFT32C0150	93€	150	BK2-DWFT5260150	112€	150	BK2-DWFT5270150	157€
180	BK2-DWFT5490180	274€	180	BK2-DWFT320180	97€	180	BK2-DWFT32C0180	107€	180	BK2-DWFT5260180	129€	180	BK2-DWFT5270180	180€
200	BK2-DWFT5490200	284€	200	BK2-DWFT320200	109€	200	BK2-DWFT32C0200	128€	200	BK2-DWFT5260200	148€	200	BK2-DWFT5270200	209€
250	BK2-DWFT5490250	309€	250	BK2-DWFT320250	135€	250	BK2-DWFT32C0250	152€	250	BK2-DWFT5260250	181€	250	BK2-DWFT5270250	258€
300	BK2-DWFT5490300	337€	300	BK2-DWFT320300	172€	300	BK2-DWFT32C0300	194€	300	BK2-DWFT5260300	237€	300	BK2-DWFT5270300	331€
350	BK2-DWFT5490350	358€	350	BK2-DWFT320350	211€	350	BK2-DWFT32C0350	241€	350	BK2-DWFT5260350	290€	350	BK2-DWFT5270350	382€
400	BK2-DWFT5490400	507€	400	BK2-DWFT320400	267€	400	BK2-DWFT32C0400	303€	400	BK2-DWFT5260400	359€	400	BK2-DWFT5270400	430€
450	BK2-DWFT5490450	551€	450	BK2-DWFT320450	288€	450	BK2-DWFT32C0450	327€	450	BK2-DWFT5260450	862€			
500	BK2-DWFT5490500	586€	500	BK2-DWFT320500	317€	500	BK2-DWFT32C0500	357€	500	BK2-DWFT5260500	879€			
550	BK2-DWFT5490550	624€	550	BK2-DWFT320550	333€	550	BK2-DWFT32C0550	379€	550	BK2-DWFT5260550	991€			
600	BK2-DWFT5490600	660€	600	BK2-DWFT320600	347€	600	BK2-DWFT32C0600	396€	600	BK2-DWFT5260600	1008€			
650	BK2-DWFT5490650	742€	650	BK2-DWFT320650	430€	650	BK2-DWFT32C0650	490€						
700	BK2-DWFT5490700	802€	700	BK2-DWFT320700	455€	700	BK2-DWFT32C0700	517€						
750	BK2-DWFT5490750	840€	750	BK2-DWFT320750	481€	750	BK2-DWFT32C0750	552€						
800	BK2-DWFT5490800	883€	800	BK2-DWFT320800	540€	800	BK2-DWFT32C0800	611€						



# Sistema DW - FT EI30



Terminal horizontal con rejilla



Terminal JET

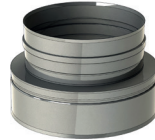

Adaptador doble a simple

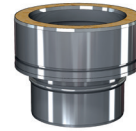

Adaptador simple a doble



Adaptador plano de salida

130	BK2-DWFT5320130	93€	130	BK2-DWFT340130	779€	130	BK2-DWFT37A0130	55€	130	BK2-DWFT370130	55€	130	650-DWFT2590130	54€
150	BK2-DWFT5320150	102€	150	BK2-DWFT340150	976€	150	BK2-DWFT37A0150	61€	150	BK2-DWFT370150	61€	150	650-DWFT2590150	65€
180	BK2-DWFT5320180	116€	180	BK2-DWFT340180	1072€	180	BK2-DWFT37A0180	74€	180	BK2-DWFT370180	74€	180	650-DWFT2590180	76€
200	BK2-DWFT5320200	138€	200	BK2-DWFT340200	1099€	200	BK2-DWFT37A0200	87€	200	BK2-DWFT370200	87€	200	650-DWFT2590200	84€
250	BK2-DWFT5320250	166€	250	BK2-DWFT340250	1328€	250	BK2-DWFT37A0250	103€	250	BK2-DWFT370250	103€	250	650-DWFT2590250	100€
300	BK2-DWFT5320300	212€	300	BK2-DWFT340300	1761€	300	BK2-DWFT37A0300	134€	300	BK2-DWFT370300	134€	300	650-DWFT2590300	129€
350	BK2-DWFT5320350	284€	350	BK2-DWFT340350	1890€	350	BK2-DWFT37A0350	167€	350	BK2-DWFT370350	167€	350	650-DWFT2590350	161€
400	BK2-DWFT5320400	325€	400	BK2-DWFT340400	2127€	400	BK2-DWFT37A0400	206€	400	BK2-DWFT370400	206€	400	650-DWFT2590400	202€
450	BK2-DWFT5320450	479€	450	BK2-DWFT340450	2638€	450	BK2-DWFT37A0450	234€	450	BK2-DWFT370450	234€	450	650-DWFT2590450	218€
500	BK2-DWFT5320500	500€	500	BK2-DWFT340500	2835€	500	BK2-DWFT37A0500	245€	500	BK2-DWFT370500	245€	500	650-DWFT2590500	236€
550	BK2-DWFT5320550	699€	550	BK2-DWFT340550	3435€	550	BK2-DWFT37A0550	272€	550	BK2-DWFT370550	272€	550	650-DWFT2590550	296€
600	BK2-DWFT5320600	779€	600	BK2-DWFT340600	3728€	600	BK2-DWFT37A0600	294€	600	BK2-DWFT370600	294€	600	650-DWFT2590600	303€
650	BK2-DWFT5320650	846€	650	BK2-DWFT340650	4576€	650	BK2-DWFT37A0650	366€	650	BK2-DWFT370650	366€	650	650-DWFT2590650	328€
700	BK2-DWFT5320700	917€	700	BK2-DWFT340700	4821€	700	BK2-DWFT37A0700	386€	700	BK2-DWFT370700	386€	700	650-DWFT2590700	356€
750	BK2-DWFT5320750	983€	750	BK2-DWFT340750	5122€	750	BK2-DWFT37A0750	413€	750	BK2-DWFT370750	413€	750	650-DWFT2590750	379€
800	BK2-DWFT5320800	1045€	800	BK2-DWFT340800	5703€	800	BK2-DWFT37A0800	460€	800	BK2-DWFT370800	460€	800	650-DWFT2590800	406€



Adaptador plano de entrada

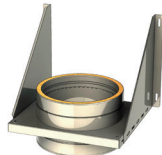

Soporte de carga regulable

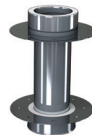

Pasamuros EI



Abrazadera de unión 2.0



Abrazadera fijación pared regulable 50-80mm

130	BK2-DWFT2600130	60€	130	BK2-DWFT3790130	192€	130	BK2-DWFT43300130	451€	130	665-ZUWA9890180	14.65€	130	665-ZUWA5560180	39.04€
150	BK2-DWFT2600150	70€	150	BK2-DWFT3790150	216€	150	BK2-DWFT43300150	480€	150	665-ZUWA9890200	17.9€	150	665-ZUWA5560200	45.58€
180	BK2-DWFT2600180	83€	180	BK2-DWFT3790180	250€	180	BK2-DWFT43300180	536€	180	665-ZUWA9890230	19.51€	180	665-ZUWA5560230	52€
200	BK2-DWFT2600200	95€	200	BK2-DWFT3790200	288€	200	BK2-DWFT43300200	599€	200	665-ZUWA9890250	26.04€	200	665-ZUWA5560250	61€
250	BK2-DWFT2600250	111€	250	BK2-DWFT3790250	349€	250	BK2-DWFT43300250	687€	250	665-ZUWA9890300	30.9€	250	665-ZUWA5560300	64€
300	BK2-DWFT2600300	144€	300	BK2-DWFT3790300	454€	300	BK2-DWFT43300300	794€	300	665-ZUWA9890350	34.15€	300	665-ZUWA5560350	67€
350	BK2-DWFT2600350	180€	350	BK2-DWFT3790350	563€	350	BK2-DWFT43300350	911€	350	665-ZUWA9890400	42.42€	350	665-ZUWA5560400	88€
400	BK2-DWFT2600400	222€	400	BK2-DWFT3790400	703€	400	BK2-DWFT43300400	1055€	400	665-ZUWA9890450	48.72€	400	665-ZUWA5560450	98€
450	BK2-DWFT2600450	242€	450	BK2-DWFT3790450	765€	450	BK2-DWFT43300450	1203€	450	665-ZUWA9890500	54€			
500	BK2-DWFT2600500	262€	500	BK2-DWFT3790500	835€	500	BK2-DWFT43300500	1350€	500	665-ZUWA9890550	58€			
550	BK2-DWFT2600550	327€	550	BK2-DWFT3790550	959€	550	BK2-DWFT43300550	1458€	550	665-ZUWA9890600	66€			
600	BK2-DWFT2600600	337€	600	BK2-DWFT3790600	1067€	600	BK2-DWFT43300600	1607€	600	665-ZUWA9890650	73€			
650	BK2-DWFT2600650	367€	650	BK2-DWFT3790650	1333€	650	BK2-DWFT43300650	1717€	650	665-ZUWA9890715	96€			
700	BK2-DWFT2600700	401€	700	BK2-DWFT3790700	1401€	700	BK2-DWFT43300700	1911€	700	665-ZUWA9890765	107€			
750	BK2-DWFT2600750	428€	750	BK2-DWFT3790750	1486€	750	BK2-DWFT43300750	2064€	750	665-ZUWA9890815	114€			
800	BK2-DWFT2600800	459€	800	BK2-DWFT3790800	1662€	800	BK2-DWFT43300800	2179€	800	665-ZUWA9890865	121€			

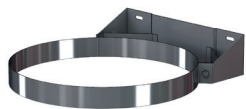

Abrazadera fijación pared fija



Base de abrazadera distanciadora



Alas distanciadoras A



Alas distanciadoras B



Alas distanciadoras C

450	665-ZUWA556F0500	123€	130	665-ZUWA14620180	52€	130	665-ZUWA1462A	47.13€	130	665-ZUWA1462B	65€	130	665-ZUWA1462C	81€
500	665-ZUWA556F0550	155€	150	665-ZUWA14620200	58€	150	665-ZUWA1462A	47.13€	150	665-ZUWA1462B	65€	150	665-ZUWA1462C	81€
550	665-ZUWA556F0600	185€	180	665-ZUWA14620230	77€	180	665-ZUWA1462A	47.13€	180	665-ZUWA1462B	65€	180	665-ZUWA1462C	81€
600	665-ZUWA556F0650	203€	200	665-ZUWA14620250	100€	200	665-ZUWA1462A	47.13€	200	665-ZUWA1462B	65€	200	665-ZUWA1462C	81€
650	665-ZUWA556F0715	290€	250	665-ZUWA14620300	138€	250	665-ZUWA1462A	47.13€	250	665-ZUWA1462B	65€	250	665-ZUWA1462C	81€
700	665-ZUWA556F0765	337€	300	665-ZUWA14620350	185€	300	665-ZUWA1462A	47.13€	300	665-ZUWA1462B	65€	300	665-ZUWA1462C	81€
750	665-ZUWA556F0815	367€	350	665-ZUWA14620400	241€	350	665-ZUWA1462A	47.13€	350	665-ZUWA1462B	65€	350	665-ZUWA1462C	81€
800	665-ZUWA556F0865	387€	400	665-ZUWA14620450	298€	400	665-ZUWA1462A	47.13€	400	665-ZUWA1462B	65€	400	665-ZUWA1462C	81€
			450	665-ZUWA14620500	328€	450	665-ZUWA1462A	47.13€	450	665-ZUWA1462B	65€	450	665-ZUWA1462C	81€
			500	665-ZUWA14620550	365€	500	665-ZUWA1462A	47.13€	500	665-ZUWA1462B	65€	500	665-ZUWA1462C	81€
			550	665-ZUWA14620600	412€	550	665-ZUWA1462A	47.13€	550	665-ZUWA1462B	65€	550	665-ZUWA1462C	81€
			600	665-ZUWA14620650	444€	600	665-ZUWA1462A	47.13€	600	665-ZUWA1462B	65€	600	665-ZUWA1462C	81€
			650	665-ZUWA14620715	580€	650	665-ZUWA1462A	47.13€	650	665-ZUWA1462B	65€	650	665-ZUWA1462C	81€
			700	665-ZUWA14620765	688€	700	665-ZUWA1462A	47.13€	700	665-ZUWA1462B	65€	700	665-ZUWA1462C	81€
			750	665-ZUWA14620815	812€	750	665-ZUWA1462A	47.13€	750	665-ZUWA1462B	65€	750	665-ZUWA1462C	81€
			800	665-ZUWA14620865	850€	800	665-ZUWA1462A	47.13€	800	665-ZUWA1462B	65€	800	665-ZUWA1462C	81€

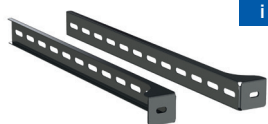

Alas distanciadoras D

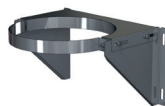

Abrazadera de soporte



Abrazadera con doble pértiga telescópica L=2000mm

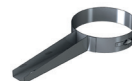

Abrazadera forjado inox



Abrazadera para amarre por tornillo

130	665-ZUWA1462D	104€	130	665-ZUWA8580180	145€	130	665-ZUWA1910180	156€	130	665-ZUWA620180	42.42€	130	665-ZUWA10630180	39.04€
150	665-ZUWA1462D	104€	150	665-ZUWA8580200	145€	150	665-ZUWA1910200	173€	150	665-ZUWA620200	47.13€	150	665-ZUWA10630200	42.42€
180	665-ZUWA1462D	104€	180	665-ZUWA8580230	163€	180	665-ZUWA1910230	179€	180	665-ZUWA620230	50€	180	665-ZUWA10630230	50€
200	665-ZUWA1462D	104€	200	665-ZUWA8580250	185€	200	665-ZUWA1910250	196€	200	665-ZUWA620250	50€	200	665-ZUWA10630250	50€
250	665-ZUWA1462D	104€	250	665-ZUWA8580300	203€	250	665-ZUWA1910300	233€	250	665-ZUWA620300	59€	250	665-ZUWA10630300	65€
300	665-ZUWA1462D	104€	300	665-ZUWA8580350	221€	300	665-ZUWA1910350	249€	300	665-ZUWA620350	66€	300	665-ZUWA10630350	74€
350	665-ZUWA1462D	104€	350	665-ZUWA8580400	270€	350	665-ZUWA1910400	272€	350	665-ZUWA620400	74€	350	665-ZUWA10630400	84€
400	665-ZUWA1462D	104€	400	665-ZUWA8580450	321€	400	665-ZUWA1910450	380€	400	665-ZUWA620450	83€	400	665-ZUWA10630450	97€
450	665-ZUWA1462D	104€	450	665-ZUWA8580500	354€	450	665-ZUWA1910500	496€	450	665-ZUWA620500	96€	450	665-ZUWA10630500	106€
500	665-ZUWA1462D	104€	500	665-ZUWA8580550	401€	500	665-ZUWA1910550	647€	500	665-ZUWA620550	103€	500	665-ZUWA10630550	114€
550	665-ZUWA1462D	104€	550	665-ZUWA8580600	454€	550	665-ZUWA1910600	699€	550	665-ZUWA620600	109€	550	665-ZUWA10630600	129€
600	665-ZUWA1462D	104€	600	665-ZUWA8580650	492€	600	665-ZUWA1910650	766€	600	665-ZUWA620650	115€	600	665-ZUWA10630650	139€
650	665-ZUWA1462D	104€	650	665-ZUWA8580715	706€	650	665-ZUWA1910715	930€				650	665-ZUWA10630715	157€
700	665-ZUWA1462D	104€	700	665-ZUWA8580765	825€	700	665-ZUWA1910765	1055€				700	665-ZUWA10630765	173€
750	665-ZUWA1462D	104€	750	665-ZUWA8580815	899€	750	665-ZUWA1910815	1164€				750	665-ZUWA10630815	185€
800	665-ZUWA1462D	104€	800	665-ZUWA8580865	943€	800	665-ZUWA1910865	1222€				800	665-ZUWA10630865	191€



# Sistema DW-FT EI30

Necesario instalar collarín con el cubreaguas.

Consultar página 91 para ver distancias de separación.



Abrazadera vientos



Collarín antitormenta

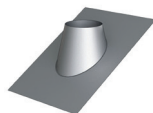

Cubreaguas 25°-45° aluminio

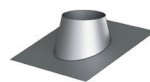

Cubreaguas 5°-25° aluminio

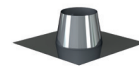

Cubreaguas plano inox

130	665-ZUWA420180	21.16€	130	665-ZUWA3070180	40.87€	130	665-ZUWA939AL0180	250€	130	665-ZUWA938AL0180	235€	130	665-ZUWA11280180	170€
150	665-ZUWA420200	26.04€	150	665-ZUWA3070200	47.13€	150	665-ZUWA939AL0200	269€	150	665-ZUWA938AL0200	252€	150	665-ZUWA11280200	185€
180	665-ZUWA420230	27.67€	180	665-ZUWA3070230	52€	180	665-ZUWA939AL0230	288€	180	665-ZUWA938AL0230	261€	180	665-ZUWA11280230	191€
200	665-ZUWA420250	29.27€	200	665-ZUWA3070250	59€	200	665-ZUWA939AL0250	305€	200	665-ZUWA938AL0250	282€	200	665-ZUWA11280250	211€
250	665-ZUWA420300	34.15€	250	665-ZUWA3070300	71€	250	665-ZUWA939AL0300	332€	250	665-ZUWA938AL0300	317€	250	665-ZUWA11280300	233€
300	665-ZUWA420350	37.43€	300	665-ZUWA3070350	77€	300	665-ZUWA939AL0350	387€	300	665-ZUWA938AL0350	351€	300	665-ZUWA11280350	260€
350	665-ZUWA420400	40.87€	350	665-ZUWA3070400	83€	350	665-ZUWA939AL0400	433€	350	665-ZUWA938AL0400	390€	350	665-ZUWA11280400	286€
400	665-ZUWA420450	56€	400	665-ZUWA3070450	114€	400	665-ZUWA939AL0450	492€	400	665-ZUWA938AL0450	436€	400	665-ZUWA11280450	306€
450	665-ZUWA420500	74€	450	665-ZUWA3070500	151€	450	665-ZUWA939AL0500	549€	450	665-ZUWA938AL0500	488€	450	665-ZUWA11280500	352€
500	665-ZUWA420550	98€	500	665-ZUWA3070550	199€	500	665-ZUWA939AL0550	607€	500	665-ZUWA938AL0550	524€	500	665-ZUWA11280550	389€
550	665-ZUWA420600	106€	550	665-ZUWA3070600	211€	550	665-ZUWA939AL0600	661€	550	665-ZUWA938AL0600	573€	550	665-ZUWA11280600	437€
600	665-ZUWA420650	114€	600	665-ZUWA3070650	234€	600	665-ZUWA939AL0650	730€	600	665-ZUWA938AL0650	618€	600	665-ZUWA11280650	492€
650	665-ZUWA420715	168€	650	665-ZUWA3070715	283€	650	665-ZUWA939AL0715	852€	650	665-ZUWA938AL0715	684€	650	665-ZUWA11280715	570€
700	665-ZUWA420765	196€	700	665-ZUWA3070765	321€	700	665-ZUWA939AL0765	950€	700	665-ZUWA938AL0765	785€	700	665-ZUWA11280765	598€
750	665-ZUWA420815	210€	750	665-ZUWA3070815	356€	750	665-ZUWA939AL0815	1192€	750	665-ZUWA938AL0815	918€	750	665-ZUWA11280815	633€
800	665-ZUWA420865	220€	800	665-ZUWA3070865	369€	800	665-ZUWA939AL0865	1297€	800	665-ZUWA938AL0865	1055€	800	665-ZUWA11280865	662€

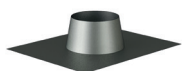

Cubreaguas plomo 0°-5°

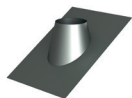

Cubreaguas plomo 25°-45°

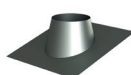

Cubreaguas plomo 5°-25°

130	665-ZUWA9370180	234€	130	665-ZUWA9390180	379€	130	665-ZUWA9380180	234€
150	665-ZUWA9370200	260€	150	665-ZUWA9390200	386€	150	665-ZUWA9380200	260€
180	665-ZUWA9370230	269€	180	665-ZUWA9390230	397€	180	665-ZUWA9380230	269€
200	665-ZUWA9370250	294€	200	665-ZUWA9390250	401€	200	665-ZUWA9380250	294€
250	665-ZUWA9370300	323€	250	665-ZUWA9390300	417€	250	665-ZUWA9380300	323€
300	665-ZUWA9370350	361€	300	665-ZUWA9390350	431€	300	665-ZUWA9380350	361€
350	665-ZUWA9370400	396€	350	665-ZUWA9390400	454€	350	665-ZUWA9380400	396€
400	665-ZUWA9370450	428€	400	665-ZUWA9390450	541€	400	665-ZUWA9380450	428€
450	665-ZUWA9370500	488€	450	665-ZUWA9390500	618€	450	665-ZUWA9380500	488€
500	665-ZUWA9370550	539€	500	665-ZUWA9390550	691€	500	665-ZUWA9380550	539€
550	665-ZUWA9370600	606€	550	665-ZUWA9390600	775€	550	665-ZUWA9380600	606€
600	665-ZUWA9370650	684€	600	665-ZUWA9390650	869€	600	665-ZUWA9380650	684€
650	665-ZUWA9370715	789€	650	665-ZUWA9390715	1006€	650	665-ZUWA9380715	789€
700	665-ZUWA9370765	832€	700	665-ZUWA9390765	1057€	700	665-ZUWA9380765	832€
750	665-ZUWA9370815	880€	750	665-ZUWA9390815	1115€	750	665-ZUWA9380815	880€
800	665-ZUWA9370865	920€	800	665-ZUWA9390865	1168€	800	665-ZUWA9380865	920€

## AMPLIACIÓN

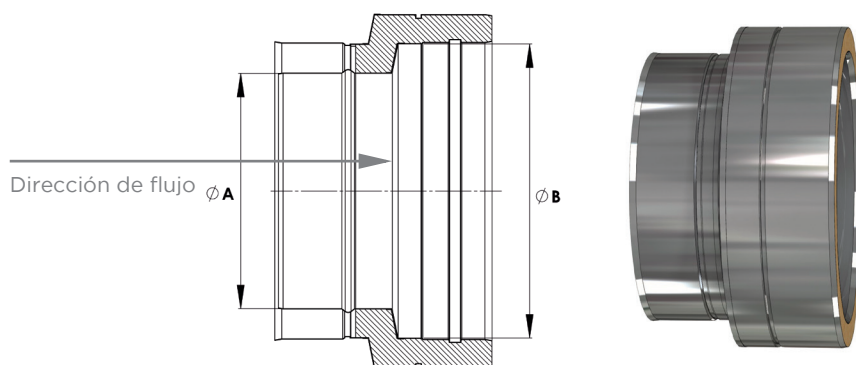

CÓDIGO	Ø A	Ø B	€
BK2-DWFTA00800130	Ø80	Ø130	135€
BK2-DWFTA00800150	Ø80	Ø150	174€
BK2-DWFTA00800180	Ø80	Ø180	218€
BK2-DWFTA01000130	Ø100	Ø130	127€
BK2-DWFTA01000150	Ø100	Ø150	172€
BK2-DWFTA01000180	Ø100	Ø180	216€
BK2-DWFTA01000200	Ø100	Ø200	279€
BK2-DWFTA01300150	Ø130	Ø150	158€
BK2-DWFTA01300180	Ø130	Ø180	208€
BK2-DWFTA01300200	Ø130	Ø200	268€
BK2-DWFTA01300250	Ø130	Ø250	345€
BK2-DWFTA01300300	Ø130	Ø300	418€
BK2-DWFTA01500180	Ø150	Ø180	190€
BK2-DWFTA01500200	Ø150	Ø200	256€
BK2-DWFTA01500250	Ø150	Ø250	334€
BK2-DWFTA01500300	Ø150	Ø300	399€
BK2-DWFTA01500350	Ø150	Ø350	493€
BK2-DWFTA01800200	Ø180	Ø200	235€
BK2-DWFTA01800250	Ø180	Ø250	320€
BK2-DWFTA01800300	Ø180	Ø300	380€
BK2-DWFTA01800350	Ø180	Ø350	473€
BK2-DWFTA01800400	Ø180	Ø400	608€
BK2-DWFTA02000250	Ø200	Ø250	294€
BK2-DWFTA02000300	Ø200	Ø300	370€
BK2-DWFTA02000350	Ø200	Ø350	460€
BK2-DWFTA02000400	Ø200	Ø400	584€
BK2-DWFTA02000450	Ø200	Ø450	823€
BK2-DWFTA02500300	Ø250	Ø300	341€
BK2-DWFTA02500350	Ø250	Ø350	440€
BK2-DWFTA02500400	Ø250	Ø400	560€
BK2-DWFTA02500450	Ø250	Ø450	794€
BK2-DWFTA02500500	Ø250	Ø500	936€
BK2-DWFTA03000350	Ø300	Ø350	405€
BK2-DWFTA03000400	Ø300	Ø400	541€
BK2-DWFTA03000450	Ø300	Ø450	766€
BK2-DWFTA03000500	Ø300	Ø500	898€

BK2-DWFTA03000550	Ø300	Ø550	991€
BK2-DWFTA03500400	Ø350	Ø400	496€
BK2-DWFTA03500450	Ø350	Ø450	734€
BK2-DWFTA03500500	Ø350	Ø500	867€
BK2-DWFTA03500550	Ø350	Ø550	957€
BK2-DWFTA03500600	Ø350	Ø600	1212€
BK2-DWFTA04000450	Ø400	Ø450	675€
BK2-DWFTA04000500	Ø400	Ø500	830€
BK2-DWFTA04000550	Ø400	Ø550	917€
BK2-DWFTA04000600	Ø400	Ø600	1165€
BK2-DWFTA04000650	Ø400	Ø650	1516€
BK2-DWFTA04500500	Ø450	Ø500	759€
BK2-DWFTA04500550	Ø450	Ø550	882€
BK2-DWFTA04500600	Ø450	Ø600	1120€
BK2-DWFTA04500650	Ø450	Ø650	1455€
BK2-DWFTA04500700	Ø450	Ø700	1589€
BK2-DWFTA05000550	Ø500	Ø550	806€
BK2-DWFTA05000600	Ø500	Ø600	1075€
BK2-DWFTA05000650	Ø500	Ø650	1399€
BK2-DWFTA05000700	Ø500	Ø700	1529€
BK2-DWFTA05000750	Ø500	Ø750	1688€
BK2-DWFTA05500600	Ø550	Ø600	985€
BK2-DWFTA05500650	Ø550	Ø650	1340€
BK2-DWFTA05500700	Ø550	Ø700	1471€
BK2-DWFTA05500750	Ø550	Ø750	1625€
BK2-DWFTA05500800	Ø550	Ø800	1894€
BK2-DWFTA06000650	Ø600	Ø650	1227€
BK2-DWFTA06000700	Ø600	Ø700	1412€
BK2-DWFTA06000750	Ø600	Ø750	1563€
BK2-DWFTA06000800	Ø600	Ø800	1822€
BK2-DWFTA06500700	Ø650	Ø700	1290€
BK2-DWFTA06500750	Ø650	Ø750	1499€
BK2-DWFTA06500800	Ø650	Ø800	1751€
BK2-DWFTA07000750	Ø700	Ø750	1372€
BK2-DWFTA07000800	Ø700	Ø800	1681€
BK2-DWFTA07500800	Ø750	Ø800	1537€



REDUCCIÓN

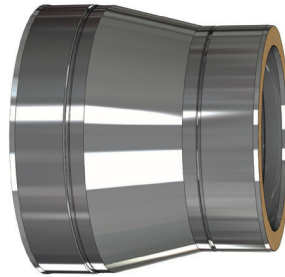
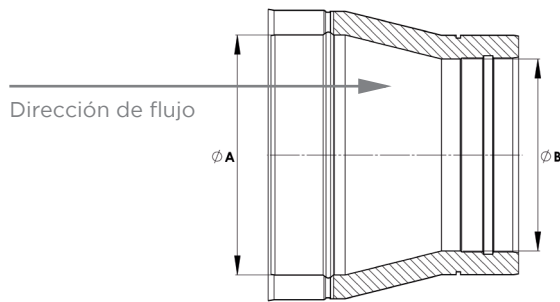

CÓDIGO	Ø A	Ø B	€
BK2-DWFTR01500130	Ø150	Ø130	158€
BK2-DWFTR01800130	Ø180	Ø130	210€
BK2-DWFTR01800150	Ø180	Ø150	192€
BK2-DWFTR02000130	Ø200	Ø130	271€
BK2-DWFTR02000150	Ø200	Ø150	260€
BK2-DWFTR02000180	Ø200	Ø180	238€
BK2-DWFTR03000250	Ø300	Ø250	344€
BK2-DWFTR03500250	Ø350	Ø250	447€
BK2-DWFTR03500300	Ø350	Ø300	409€
BK2-DWFTR04000250	Ø400	Ø250	570€
BK2-DWFTR04000300	Ø400	Ø300	546€
BK2-DWFTR04000350	Ø400	Ø350	497€
BK2-DWFTR04500250	Ø450	Ø250	803€
BK2-DWFTR04500300	Ø450	Ø300	773€
BK2-DWFTR04500350	Ø450	Ø350	737€
BK2-DWFTR04500400	Ø450	Ø400	676€
BK2-DWFTR05000250	Ø500	Ø250	950€
BK2-DWFTR05000300	Ø500	Ø300	908€
BK2-DWFTR05000350	Ø500	Ø350	873€
BK2-DWFTR05000400	Ø500	Ø400	836€
BK2-DWFTR05000450	Ø500	Ø450	763€
BK2-DWFTR05500300	Ø550	Ø300	1004€
BK2-DWFTR05500350	Ø550	Ø350	967€
BK2-DWFTR05500400	Ø550	Ø400	924€
BK2-DWFTR05500450	Ø550	Ø450	888€

BK2-DWFTR05500500	Ø550	Ø500	810€
BK2-DWFTR06000350	Ø600	Ø350	1227€
BK2-DWFTR06000400	Ø600	Ø400	1176€
BK2-DWFTR06000450	Ø600	Ø450	1129€
BK2-DWFTR06000500	Ø600	Ø500	1083€
BK2-DWFTR06000550	Ø600	Ø550	988€
BK2-DWFTR06500400	Ø650	Ø400	1532€
BK2-DWFTR06500450	Ø650	Ø450	1471€
BK2-DWFTR06500500	Ø650	Ø500	1410€
BK2-DWFTR06500550	Ø650	Ø550	1348€
BK2-DWFTR06500600	Ø650	Ø600	1232€
BK2-DWFTR07000450	Ø700	Ø450	1608€
BK2-DWFTR07000500	Ø700	Ø500	1545€
BK2-DWFTR07000550	Ø700	Ø550	1484€
BK2-DWFTR07000600	Ø700	Ø600	1421€
BK2-DWFTR07000650	Ø700	Ø650	1297€
BK2-DWFTR07500500	Ø750	Ø500	1710€
BK2-DWFTR07500550	Ø750	Ø550	1642€
BK2-DWFTR07500600	Ø750	Ø600	1578€
BK2-DWFTR07500650	Ø750	Ø650	1509€
BK2-DWFTR07500700	Ø750	Ø700	1377€
BK2-DWFTR08000550	Ø800	Ø550	1915€
BK2-DWFTR08000600	Ø800	Ø600	1839€
BK2-DWFTR08000650	Ø800	Ø650	1763€
BK2-DWFTR08000700	Ø800	Ø700	1688€
BK2-DWFTR08000750	Ø800	Ø750	1541€

## Conducto modular metálico con resistencia al fuego EI60 para ventilación de doble pared fabricado en acero inoxidable interior y exterior.

### MATERIAL

Pared Interior: Acero inoxidable

Pared Exterior: Acero inoxidable

### ACABADO EXTERIOR

Brillante

### AISLAMIENTO

Aislante mineral de alta densidad de 50 mm de espesor.

### ESPEORES (mm)

Pared interior: 0,4 - 0,5 - 0,6 - 0,8 (según diámetro)

Aislamiento: 50 mm

Pared exterior: 0,4 - 0,5 - 0,6 - 0,8 (según diámetro)

### DIÁMETROS DISPONIBLES (mm)

Ø130 a Ø800

### SISTEMA DE UNIÓN

Conexión macho-hembra con **abrazadera de unión ancha (2.0)**



\*Sólo con junta



### APLICACIONES

- Ventilación de garajes
- Sectorización de zonas de incendio de riesgo medio
- Climatización



### CARACTERÍSTICAS

- **Estanqueidad clase C según norma UNE-EN 12237** con la instalación de juntas de estanqueidad
- **Soldadura TIG/LASER** en continuo en todas las piezas
- **Abrazadera de unión incluida (excepto terminales)**

### CLASIFICACIONES EI (UNE-EN 13501-3)

EI 60 (ve i → o)

EI 60 (hø i → o)



# Sistema SV - FT EI60



Módulo recto 1000mm



Módulo recto 500mm



Módulo recto 250mm



Módulo recto regulable  
400-560mm



Módulo recto regulable  
560-920mm

130	BV1-DWFT130130	275€	130	BV1-DWFT140130	183€	130	BV1-DWFT150130	130€	130	BV1-DWFT5440130	252€	130	BV1-DWFT5450130	374€
150	BV1-DWFT130150	306€	150	BV1-DWFT140150	205€	150	BV1-DWFT150150	145€	150	BV1-DWFT5440150	281€	150	BV1-DWFT5450150	419€
180	BV1-DWFT130180	345€	180	BV1-DWFT140180	244€	180	BV1-DWFT150180	176€	180	BV1-DWFT5440180	339€	180	BV1-DWFT5450180	465€
200	BV1-DWFT130200	378€	200	BV1-DWFT140200	255€	200	BV1-DWFT150200	182€	200	BV1-DWFT5440200	349€	200	BV1-DWFT5450200	474€
250	BV1-DWFT130250	484€	250	BV1-DWFT140250	312€	250	BV1-DWFT150250	228€	250	BV1-DWFT5440250	444€	250	BV1-DWFT5450250	594€
300	BV1-DWFT130300	561€	300	BV1-DWFT140300	383€	300	BV1-DWFT150300	281€	300	BV1-DWFT5440300	522€	300	BV1-DWFT5450300	802€
350	BV1-DWFT130350	672€	350	BV1-DWFT140350	412€	350	BV1-DWFT150350	320€	350	BV1-DWFT5440350	586€	350	BV1-DWFT5450350	862€
400	BV1-DWFT130400	765€	400	BV1-DWFT140400	497€	400	BV1-DWFT150400	397€	400	BV1-DWFT5440400	720€	400	BV1-DWFT5450400	1019€
450	BV1-DWFT130450	857€	450	BV1-DWFT140450	541€	450	BV1-DWFT150450	452€	450	BV1-DWFT5440450	810€	450	BV1-DWFT5450450	1090€
500	BV1-DWFT130500	960€	500	BV1-DWFT140500	585€	500	BV1-DWFT150500	517€	500	BV1-DWFT5440500	884€	500	BV1-DWFT5450500	1192€
550	BV1-DWFT130550	1069€	550	BV1-DWFT140550	736€	550	BV1-DWFT150550	572€	550	BV1-DWFT5440550	920€	550	BV1-DWFT5450550	1204€
600	BV1-DWFT130600	1240€	600	BV1-DWFT140600	827€	600	BV1-DWFT150600	683€	600	BV1-DWFT5440600	1064€	600	BV1-DWFT5450600	1519€
650	BV1-DWFT130650	1346€	650	BV1-DWFT140650	897€	650	BV1-DWFT150650	741€	650	BV1-DWFT5440650	1158€	650	BV1-DWFT5450650	1648€
700	BV1-DWFT130700	1452€	700	BV1-DWFT140700	968€	700	BV1-DWFT150700	801€	700	BV1-DWFT5440700	1245€	700	BV1-DWFT5450700	1776€
750	BV1-DWFT130750	1544€	750	BV1-DWFT140750	1026€	750	BV1-DWFT150750	850€	750	BV1-DWFT5440750	1323€	750	BV1-DWFT5450750	1885€
800	BV1-DWFT130800	1725€	800	BV1-DWFT140800	1147€	800	BV1-DWFT150800	952€	800	BV1-DWFT5440800	1481€	800	BV1-DWFT5450800	2108€



Codo 15°



Codo 30°



Codo 45°

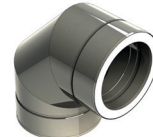

Codo 90°

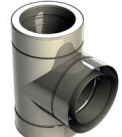

Te 90°

130	BV1-DWFT160130	190€	130	BV1-DWFT170130	190€	130	BV1-DWFT180130	190€	130	BV1-DWFT600130	273€	130	BV1-DWFT3170130	396€
150	BV1-DWFT160150	211€	150	BV1-DWFT170150	211€	150	BV1-DWFT180150	211€	150	BV1-DWFT600150	304€	150	BV1-DWFT3170150	440€
180	BV1-DWFT160180	255€	180	BV1-DWFT170180	255€	180	BV1-DWFT180180	255€	180	BV1-DWFT600180	357€	180	BV1-DWFT3170180	534€
200	BV1-DWFT160200	262€	200	BV1-DWFT170200	262€	200	BV1-DWFT180200	262€	200	BV1-DWFT600200	376€	200	BV1-DWFT3170200	565€
250	BV1-DWFT160250	324€	250	BV1-DWFT170250	324€	250	BV1-DWFT180250	324€	250	BV1-DWFT600250	474€	250	BV1-DWFT3170250	717€
300	BV1-DWFT160300	376€	300	BV1-DWFT170300	376€	300	BV1-DWFT180300	376€	300	BV1-DWFT600300	577€	300	BV1-DWFT3170300	873€
350	BV1-DWFT160350	484€	350	BV1-DWFT170350	484€	350	BV1-DWFT180350	484€	350	BV1-DWFT600350	690€	350	BV1-DWFT3170350	1036€
400	BV1-DWFT160400	650€	400	BV1-DWFT170400	650€	400	BV1-DWFT180400	650€				400	BV1-DWFT3170400	1400€
450	BV1-DWFT160450	967€	450	BV1-DWFT170450	967€	450	BV1-DWFT180450	967€				450	BV1-DWFT3170450	1647€
500	BV1-DWFT160500	1125€	500	BV1-DWFT170500	1125€	500	BV1-DWFT180500	1125€				500	BV1-DWFT3170500	2015€
550	BV1-DWFT160550	1542€	550	BV1-DWFT170550	1542€	550	BV1-DWFT180550	1542€				550	BV1-DWFT3170550	2154€
600	BV1-DWFT160600	1880€	600	BV1-DWFT170600	1880€	600	BV1-DWFT180600	1880€				600	BV1-DWFT3170600	2726€
650	BV1-DWFT160650	2041€	650	BV1-DWFT170650	2041€	650	BV1-DWFT180650	2041€				650	BV1-DWFT3170650	2957€
700	BV1-DWFT160700	2201€	700	BV1-DWFT170700	2201€	700	BV1-DWFT180700	2201€				700	BV1-DWFT3170700	3188€
750	BV1-DWFT160750	2331€	750	BV1-DWFT170750	2331€	750	BV1-DWFT180750	2331€				750	BV1-DWFT3170750	3383€
800	BV1-DWFT160800	2612€	800	BV1-DWFT170800	2612€	800	BV1-DWFT180800	2612€				800	BV1-DWFT3170800	3785€



Te 135°



Colector de hollín aislado

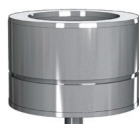

Colector de hollín con desagüe aislado



Módulo de inspección con tapa 200 Pa (P1)

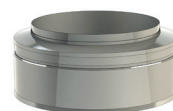

Terminal salida libre

130	BV1-DWFT120130	552€	130	835-DWFT20330130	141€	130	835-DWFT14600130	169€	130	BV1-DWFT5490130	369€	130	BV1-DWFT320130	117€
150	BV1-DWFT120150	617€	150	835-DWFT20330150	139€	150	835-DWFT14600150	169€	150	BV1-DWFT5490150	381€	150	BV1-DWFT320150	133€
180	BV1-DWFT120180	737€	180	835-DWFT20330180	163€	180	835-DWFT14600180	183€	180	BV1-DWFT5490180	404€	180	BV1-DWFT320180	160€
200	BV1-DWFT120200	768€	200	835-DWFT20330200	173€	200	835-DWFT14600200	190€	200	BV1-DWFT5490200	424€	200	BV1-DWFT320200	167€
250	BV1-DWFT120250	975€	250	835-DWFT20330250	188€	250	835-DWFT14600250	220€	250	BV1-DWFT5490250	454€	250	BV1-DWFT320250	211€
300	BV1-DWFT120300	1188€	300	835-DWFT20330300	210€	300	835-DWFT14600300	322€	300	BV1-DWFT5490300	494€	300	BV1-DWFT320300	258€
350	BV1-DWFT120350	1407€	350	835-DWFT20330350	219€	350	835-DWFT14600350	351€	350	BV1-DWFT5490350	533€	350	BV1-DWFT320350	300€
400	BV1-DWFT120400	1911€	400	835-DWFT20330400	268€	400	835-DWFT14600400	384€	400	BV1-DWFT5490400	752€	400	BV1-DWFT320400	406€
450	BV1-DWFT120450	2335€	450	835-DWFT20330450	305€	450	835-DWFT14600450	466€	450	BV1-DWFT5490450	818€	450	BV1-DWFT320450	455€
500	BV1-DWFT120500	2796€	500	835-DWFT20330500	474€	500	835-DWFT14600500	592€	500	BV1-DWFT5490500	867€	500	BV1-DWFT320500	521€
550	BV1-DWFT120550	3079€	550	835-DWFT20330550	575€	550	835-DWFT14600550	699€	550	BV1-DWFT5490550	920€	550	BV1-DWFT320550	537€
600	BV1-DWFT120600	3331€	600	835-DWFT20330600	590€	600	835-DWFT14600600	750€	600	BV1-DWFT5490600	975€	600	BV1-DWFT320600	575€
650	BV1-DWFT120650	3608€	650	835-DWFT20330650	597€	650	835-DWFT14600650	790€	650	BV1-DWFT5490650	1096€	650	BV1-DWFT320650	626€
700	BV1-DWFT120700	3887€	700	835-DWFT20330700	611€	700	835-DWFT14600700	812€	700	BV1-DWFT5490700	1180€	700	BV1-DWFT320700	675€
750	BV1-DWFT120750	4122€	750	835-DWFT20330750	647€	750	835-DWFT14600750	823€	750	BV1-DWFT5490750	1237€	750	BV1-DWFT320750	716€
800	BV1-DWFT120800	4615€	800	835-DWFT20330800	724€	800	835-DWFT14600800	922€	800	BV1-DWFT5490800	1297€	800	BV1-DWFT320800	803€

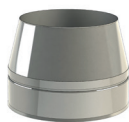

Terminal salida cónica



Terminal anti-lluvia

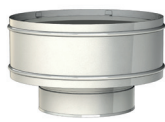

Terminal anti-viento



Terminal horizontal con rejilla



Terminal JET

130	BV1-DWFT32C0130	137€	130	BV1-DWFT5260130	164€	130	BV1-DWFT5270130	231€	130	BV1-DWFT5320130	160€	130	BV1-DWFT340130	857€
150	BV1-DWFT32C0150	149€	150	BV1-DWFT5260150	183€	150	BV1-DWFT5270150	258€	150	BV1-DWFT5320150	163€	150	BV1-DWFT340150	1069€
180	BV1-DWFT32C0180	180€	180	BV1-DWFT5260180	215€	180	BV1-DWFT5270180	307€	180	BV1-DWFT5320180	192€	180	BV1-DWFT340180	1181€
200	BV1-DWFT32C0200	193€	200	BV1-DWFT5260200	225€	200	BV1-DWFT5270200	321€	200	BV1-DWFT5320200	208€	200	BV1-DWFT340200	1210€
250	BV1-DWFT32C0250	240€	250	BV1-DWFT5260250	285€	250	BV1-DWFT5270250	409€	250	BV1-DWFT5320250	261€	250	BV1-DWFT340250	1460€
300	BV1-DWFT32C0300	290€	300	BV1-DWFT5260300	352€	300	BV1-DWFT5270300	497€	300	BV1-DWFT5320300	315€	300	BV1-DWFT340300	1933€
350	BV1-DWFT32C0350	344€	350	BV1-DWFT5260350	415€	350	BV1-DWFT5270350	543€	350	BV1-DWFT5320350	401€	350	BV1-DWFT340350	2078€
400	BV1-DWFT32C0400	465€	400	BV1-DWFT5260400	558€	400	BV1-DWFT5270400	662€	400	BV1-DWFT5320400	481€	400	BV1-DWFT340400	2334€
450	BV1-DWFT32C0450	526€							450	BV1-DWFT5320450	733€	450	BV1-DWFT340450	2899€
500	BV1-DWFT32C0500	593€							500	BV1-DWFT5320500	794€	500	BV1-DWFT340500	3113€
550	BV1-DWFT32C0550	616€							550	BV1-DWFT5320550	1104€	550	BV1-DWFT340550	3777€
600	BV1-DWFT32C0600	656€							600	BV1-DWFT5320600	1264€	600	BV1-DWFT340600	4098€
650	BV1-DWFT32C0650	710€							650	BV1-DWFT5320650	1199€	650	BV1-DWFT340650	4436€
700	BV1-DWFT32C0700	771€							700	BV1-DWFT5320700	1323€	700	BV1-DWFT340700	4777€
750	BV1-DWFT32C0750	818€							750	BV1-DWFT5320750	1404€	750	BV1-DWFT340750	5060€
800	BV1-DWFT32C0800	916€							800	BV1-DWFT5320800	1570€	800	BV1-DWFT340800	5666€



# Sistema SV - FT EI60

Consultar página 91 para ver distancias de separación.

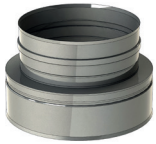

Adaptador doble a simple

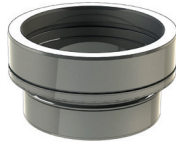

Adaptador simple a doble

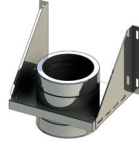

Soporte de carga regulable

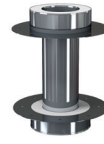

Pasamuros EI



Abrazadera de unión 2.0

130	BV1-DWFT37A0130	76€	130	BV1-DWFT370130	76€	130	BV1-DWFT3790130	318€	130	BV1-DWFT43300130	690€	130	665-ZUWA9890230	19.51€
150	BV1-DWFT37A0150	85€	150	BV1-DWFT370150	85€	150	BV1-DWFT3790150	356€	150	BV1-DWFT43300150	727€	150	665-ZUWA9890250	26.04€
180	BV1-DWFT37A0180	95€	180	BV1-DWFT370180	95€	180	BV1-DWFT3790180	425€	180	BV1-DWFT43300180	789€	180	665-ZUWA9890280	29.27€
200	BV1-DWFT37A0200	99€	200	BV1-DWFT370200	99€	200	BV1-DWFT3790200	443€	200	BV1-DWFT43300200	846€	200	665-ZUWA9890300	30.9€
250	BV1-DWFT37A0250	108€	250	BV1-DWFT370250	108€	250	BV1-DWFT3790250	561€	250	BV1-DWFT43300250	957€	250	665-ZUWA9890350	34.15€
300	BV1-DWFT37A0300	112€	300	BV1-DWFT370300	112€	300	BV1-DWFT3790300	685€	300	BV1-DWFT43300300	1065€	300	665-ZUWA9890400	42.42€
350	BV1-DWFT37A0350	126€	350	BV1-DWFT370350	126€	350	BV1-DWFT3790350	815€	350	BV1-DWFT43300350	1197€	350	665-ZUWA9890450	48.72€
400	BV1-DWFT37A0400	164€	400	BV1-DWFT370400	164€	400	BV1-DWFT3790400	1100€	400	BV1-DWFT43300400	1342€	400	665-ZUWA9890500	54€
450	BV1-DWFT37A0450	213€	450	BV1-DWFT370450	213€	450	BV1-DWFT3790450	1244€	450	BV1-DWFT43300450	1513€	450	665-ZUWA9890550	58€
500	BV1-DWFT37A0500	274€	500	BV1-DWFT370500	274€	500	BV1-DWFT3790500	1407€	500	BV1-DWFT43300500	1663€	500	665-ZUWA9890600	66€
550	BV1-DWFT37A0550	333€	550	BV1-DWFT370550	333€	550	BV1-DWFT3790550	1586€	550	BV1-DWFT43300550	1792€	550	665-ZUWA9890650	73€
600	BV1-DWFT37A0600	370€	600	BV1-DWFT370600	370€	600	BV1-DWFT3790600	1823€	600	BV1-DWFT43300600	1932€	600	665-ZUWA9890700	84€
650	BV1-DWFT37A0650	405€	650	BV1-DWFT370650	405€	650	BV1-DWFT3790650	1975€	650	BV1-DWFT43300650	2073€	650	665-ZUWA9890750	100€
700	BV1-DWFT37A0700	440€	700	BV1-DWFT370700	440€	700	BV1-DWFT3790700	2131€	700	BV1-DWFT43300700	2216€	700	665-ZUWA9890800	111€
750	BV1-DWFT37A0750	469€	750	BV1-DWFT370750	469€	750	BV1-DWFT3790750	2258€	750	BV1-DWFT43300750	2377€	750	665-ZUWA9890850	119€
800	BV1-DWFT37A0800	523€	800	BV1-DWFT370800	523€	800	BV1-DWFT3790800	2526€	800	BV1-DWFT43300800	2508€	800	665-ZUWA9890900	129€



Abrazadera fijación pared regulable 50-80mm

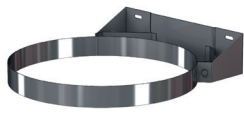

Abrazadera fijación pared fija



Base de abrazadera distanciadora



Alas distanciadoras A



Alas distanciadoras B

130	665-ZUWA5560230	52€	400	665-ZUWA556F0500	123€	130	665-ZUWA14620230	77€	130	665-ZUWA1462A	47.13€	130	665-ZUWA1462B	65€
150	665-ZUWA5560250	61€	450	665-ZUWA556F0550	155€	150	665-ZUWA14620250	100€	150	665-ZUWA1462A	47.13€	150	665-ZUWA1462B	65€
180	665-ZUWA5560280	64€	500	665-ZUWA556F0600	185€	180	665-ZUWA14620280	123€	180	665-ZUWA1462A	47.13€	180	665-ZUWA1462B	65€
200	665-ZUWA5560300	64€	550	665-ZUWA556F0650	203€	200	665-ZUWA14620300	138€	200	665-ZUWA1462A	47.13€	200	665-ZUWA1462B	65€
250	665-ZUWA5560350	67€	600	665-ZUWA556F0700	264€	250	665-ZUWA14620350	185€	250	665-ZUWA1462A	47.13€	250	665-ZUWA1462B	65€
300	665-ZUWA5560400	88€	650	665-ZUWA556F0750	321€	300	665-ZUWA14620400	241€	300	665-ZUWA1462A	47.13€	300	665-ZUWA1462B	65€
350	665-ZUWA5560450	98€	700	665-ZUWA556F0800	358€	350	665-ZUWA14620450	298€	350	665-ZUWA1462A	47.13€	350	665-ZUWA1462B	65€
			750	665-ZUWA556F0850	379€	400	665-ZUWA14620500	328€	400	665-ZUWA1462A	47.13€	400	665-ZUWA1462B	65€
			800	665-ZUWA556F0900	404€	450	665-ZUWA14620550	365€	450	665-ZUWA1462A	47.13€	450	665-ZUWA1462B	65€
						500	665-ZUWA14620600	412€	500	665-ZUWA1462A	47.13€	500	665-ZUWA1462B	65€
						550	665-ZUWA14620650	444€	550	665-ZUWA1462A	47.13€	550	665-ZUWA1462B	65€
						600	665-ZUWA14620700	572€	600	665-ZUWA1462A	47.13€	600	665-ZUWA1462B	65€
						650	665-ZUWA14620750	587€	650	665-ZUWA1462A	47.13€	650	665-ZUWA1462B	65€
						700	665-ZUWA14620800	786€	700	665-ZUWA1462A	47.13€	700	665-ZUWA1462B	65€
						750	665-ZUWA14620850	837€	750	665-ZUWA1462A	47.13€	750	665-ZUWA1462B	65€
						800	665-ZUWA14620900	886€	800	665-ZUWA1462A	47.13€	800	665-ZUWA1462B	65€

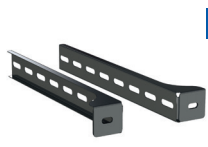

Alas distanciadoras C



Alas distanciadoras D

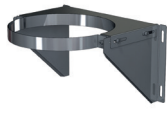

Abrazadera de soporte



Abrazadera con doble pértiga telescópica L=2000mm



Abrazadera forjado inox

130	665-ZUWA1462C	81€	130	665-ZUWA1462D	104€	130	665-ZUWA8580230	163€	130	665-ZUWA1910230	179€	130	665-ZUWA620230	50€
150	665-ZUWA1462C	81€	150	665-ZUWA1462D	104€	150	665-ZUWA8580250	185€	150	665-ZUWA1910250	196€	150	665-ZUWA620250	50€
180	665-ZUWA1462C	81€	180	665-ZUWA1462D	104€	180	665-ZUWA8580280	202€	180	665-ZUWA1910280	233€	180	665-ZUWA620280	59€
200	665-ZUWA1462C	81€	200	665-ZUWA1462D	104€	200	665-ZUWA8580300	203€	200	665-ZUWA1910300	233€	200	665-ZUWA620300	59€
250	665-ZUWA1462C	81€	250	665-ZUWA1462D	104€	250	665-ZUWA8580350	221€	250	665-ZUWA1910350	249€	250	665-ZUWA620350	66€
300	665-ZUWA1462C	81€	300	665-ZUWA1462D	104€	300	665-ZUWA8580400	270€	300	665-ZUWA1910400	272€	300	665-ZUWA620400	74€
350	665-ZUWA1462C	81€	350	665-ZUWA1462D	104€	350	665-ZUWA8580450	321€	350	665-ZUWA1910450	380€	350	665-ZUWA620450	83€
400	665-ZUWA1462C	81€	400	665-ZUWA1462D	104€	400	665-ZUWA8580500	354€	400	665-ZUWA1910500	496€	400	665-ZUWA620500	96€
450	665-ZUWA1462C	81€	450	665-ZUWA1462D	104€	450	665-ZUWA8580550	401€	450	665-ZUWA1910550	647€	450	665-ZUWA620550	103€
500	665-ZUWA1462C	81€	500	665-ZUWA1462D	104€	500	665-ZUWA8580600	454€	500	665-ZUWA1910600	699€	500	665-ZUWA620600	109€
550	665-ZUWA1462C	81€	550	665-ZUWA1462D	104€	550	665-ZUWA8580650	492€	550	665-ZUWA1910650	766€	550	665-ZUWA620650	115€
600	665-ZUWA1462C	81€	600	665-ZUWA1462D	104€	600	665-ZUWA8580700	637€	600	665-ZUWA1910700	871€	600	665-ZUWA620700	122€
650	665-ZUWA1462C	81€	650	665-ZUWA1462D	104€	650	665-ZUWA8580750	780€	650	665-ZUWA1910750	976€	650	665-ZUWA620750	130€
700	665-ZUWA1462C	81€	700	665-ZUWA1462D	104€	700	665-ZUWA8580800	870€	700	665-ZUWA1910800	1127€	700	665-ZUWA620800	136€
750	665-ZUWA1462C	81€	750	665-ZUWA1462D	104€	750	665-ZUWA8580850	929€	750	665-ZUWA1910850	1199€			
800	665-ZUWA1462C	81€	800	665-ZUWA1462D	104€	800	665-ZUWA8580900	984€	800	665-ZUWA1910900	1267€			



Abrazadera vientos



Collarín antitormenta

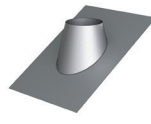

Cubreaguas 25°-45° aluminio

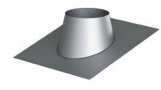

Cubreaguas 5°-25° aluminio

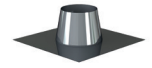

Cubreaguas plano inox

130	665-ZUWA420230	27.67€	130	665-ZUWA3070230	52€	130	665-ZUWA939AL0230	288€	130	665-ZUWA938AL0230	261€	130	665-ZUWA11280230	191€
150	665-ZUWA420250	29.27€	150	665-ZUWA3070250	59€	150	665-ZUWA939AL0250	305€	150	665-ZUWA938AL0250	282€	150	665-ZUWA11280250	211€
180	665-ZUWA420280	32.52€	180	665-ZUWA3070280	71€	180	665-ZUWA939AL0280	332€	180	665-ZUWA938AL0280	282€	180	665-ZUWA11280280	227€
200	665-ZUWA420300	34.15€	200	665-ZUWA3070300	71€	200	665-ZUWA939AL0300	332€	200	665-ZUWA938AL0300	317€	200	665-ZUWA11280300	233€
250	665-ZUWA420350	37.43€	250	665-ZUWA3070350	77€	250	665-ZUWA939AL0350	387€	250	665-ZUWA938AL0350	351€	250	665-ZUWA11280350	260€
300	665-ZUWA420400	40.87€	300	665-ZUWA3070400	83€	300	665-ZUWA939AL0400	433€	300	665-ZUWA938AL0400	390€	300	665-ZUWA11280400	286€
350	665-ZUWA420450	56€	350	665-ZUWA3070450	114€	350	665-ZUWA939AL0450	492€	350	665-ZUWA938AL0450	436€	350	665-ZUWA11280450	306€
400	665-ZUWA420500	74€	400	665-ZUWA3070500	151€	400	665-ZUWA939AL0500	549€	400	665-ZUWA938AL0500	488€	400	665-ZUWA11280500	352€
450	665-ZUWA420550	98€	450	665-ZUWA3070550	199€	450	665-ZUWA939AL0550	607€	450	665-ZUWA938AL0550	524€	450	665-ZUWA11280550	389€
500	665-ZUWA420600	106€	500	665-ZUWA3070600	211€	500	665-ZUWA939AL0600	661€	500	665-ZUWA938AL0600	573€	500	665-ZUWA11280600	437€
550	665-ZUWA420650	114€	550	665-ZUWA3070650	234€	550	665-ZUWA939AL0650	730€	550	665-ZUWA938AL0650	618€	550	665-ZUWA11280650	492€
600	665-ZUWA420700	151€	600	665-ZUWA3070700	268€	600	665-ZUWA939AL0700	840€	600	665-ZUWA938AL0700	679€	600	665-ZUWA11280700	551€
650	665-ZUWA420750	185€	650	665-ZUWA3070750	296€	650	665-ZUWA939AL0750	939€	650	665-ZUWA938AL0750	736€	650	665-ZUWA11280750	587€
700	665-ZUWA420800	204€	700	665-ZUWA3070800	343€	700	665-ZUWA939AL0800	1123€	700	665-ZUWA938AL0800	880€	700	665-ZUWA11280800	614€
750	665-ZUWA420850	218€	750	665-ZUWA3070850	365€	750	665-ZUWA939AL0850	1271€	750	665-ZUWA938AL0850	1015€	750	665-ZUWA11280850	652€
800	665-ZUWA420900	232€	800	665-ZUWA3070900	387€	800	665-ZUWA939AL0900	1348€	800	665-ZUWA938AL0900	1100€	800	665-ZUWA11280900	688€



# Sistema SV-FT EI60

Necesario instalar el elemento de cubreaguas.

Consultar página 91 para ver distancias de separación.

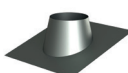
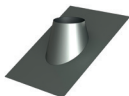
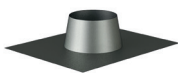

Cubreaguas plomo 0°-5°    Cubreaguas plomo 25°-45°    Cubreaguas plomo 5°-25°

130	665-ZUWA9370230	269€	130	665-ZUWA9390230	397€	130	665-ZUWA9380230	269€
150	665-ZUWA9370250	294€	150	665-ZUWA9390250	401€	150	665-ZUWA9380250	294€
180	665-ZUWA9370280	316€	180	665-ZUWA9390280	413€	180	665-ZUWA9380280	316€
200	665-ZUWA9370300	323€	200	665-ZUWA9390300	417€	200	665-ZUWA9380300	323€
250	665-ZUWA9370350	361€	250	665-ZUWA9390350	431€	250	665-ZUWA9380350	361€
300	665-ZUWA9370400	396€	300	665-ZUWA9390400	454€	300	665-ZUWA9380400	396€
350	665-ZUWA9370450	428€	350	665-ZUWA9390450	541€	350	665-ZUWA9380450	428€
400	665-ZUWA9370500	488€	400	665-ZUWA9390500	618€	400	665-ZUWA9380500	488€
450	665-ZUWA9370550	539€	450	665-ZUWA9390550	691€	450	665-ZUWA9380550	539€
500	665-ZUWA9370600	606€	500	665-ZUWA9390600	775€	500	665-ZUWA9380600	606€
550	665-ZUWA9370650	684€	550	665-ZUWA9390650	869€	550	665-ZUWA9380650	684€
600	665-ZUWA9370700	763€	600	665-ZUWA9390700	971€	600	665-ZUWA9380700	763€
650	665-ZUWA9370750	815€	650	665-ZUWA9390750	1034€	650	665-ZUWA9380750	815€
700	665-ZUWA9370800	850€	700	665-ZUWA9390800	1082€	700	665-ZUWA9380800	850€
750	665-ZUWA9370850	902€	750	665-ZUWA9390850	1151€	750	665-ZUWA9380850	902€
800	665-ZUWA9370900	955€	800	665-ZUWA9390900	1215€	800	665-ZUWA9380900	955€

## AMPLIACIÓN

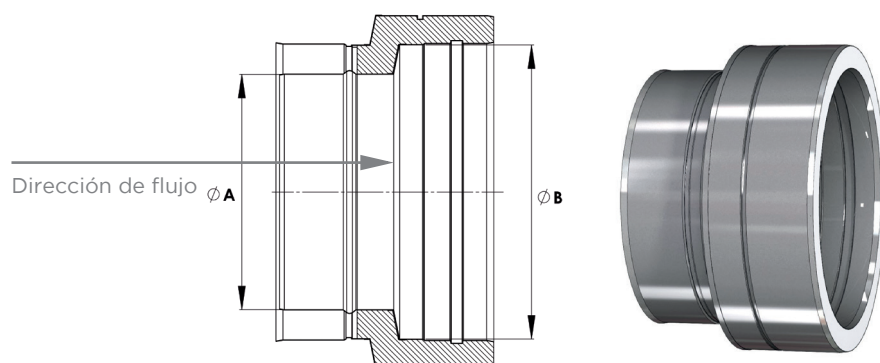

CÓDIGO	Ø A	Ø B	€
BV1-DWFTA01000130	Ø100	Ø130	133€
BV1-DWFTA01000150	Ø100	Ø150	183€
BV1-DWFTA01000180	Ø100	Ø180	229€
BV1-DWFTA01000200	Ø100	Ø200	300€
BV1-DWFTA01300150	Ø130	Ø150	166€
BV1-DWFTA01300180	Ø130	Ø180	219€
BV1-DWFTA01300200	Ø130	Ø200	284€
BV1-DWFTA01300250	Ø130	Ø250	376€
BV1-DWFTA01300300	Ø130	Ø300	447€
BV1-DWFTA01500180	Ø150	Ø180	200€
BV1-DWFTA01500200	Ø150	Ø200	276€
BV1-DWFTA01500250	Ø150	Ø250	357€
BV1-DWFTA01500300	Ø150	Ø300	431€
BV1-DWFTA01500350	Ø150	Ø350	533€
BV1-DWFTA01800200	Ø180	Ø200	251€
BV1-DWFTA01800250	Ø180	Ø250	344€
BV1-DWFTA01800300	Ø180	Ø300	415€
BV1-DWFTA01800350	Ø180	Ø350	517€
BV1-DWFTA01800400	Ø180	Ø400	650€
BV1-DWFTA02000250	Ø200	Ø250	312€
BV1-DWFTA02000300	Ø200	Ø300	396€
BV1-DWFTA02000350	Ø200	Ø350	493€
BV1-DWFTA02000400	Ø200	Ø400	628€
BV1-DWFTA02000450	Ø200	Ø450	887€
BV1-DWFTA02500300	Ø250	Ø300	361€
BV1-DWFTA02500350	Ø250	Ø350	474€
BV1-DWFTA02500400	Ø250	Ø400	599€
BV1-DWFTA02500450	Ø250	Ø450	851€
BV1-DWFTA02500500	Ø250	Ø500	1001€
BV1-DWFTA03000350	Ø300	Ø350	432€
BV1-DWFTA03000400	Ø300	Ø400	577€
BV1-DWFTA03000450	Ø300	Ø450	816€
BV1-DWFTA03000500	Ø300	Ø500	964€
BV1-DWFTA03000550	Ø300	Ø550	1063€

BV1-DWFTA03500400	Ø350	Ø400	527€
BV1-DWFTA03500450	Ø350	Ø450	783€
BV1-DWFTA03500500	Ø350	Ø500	928€
BV1-DWFTA03500550	Ø350	Ø550	1023€
BV1-DWFTA03500600	Ø350	Ø600	1296€
BV1-DWFTA04000450	Ø400	Ø450	713€
BV1-DWFTA04000500	Ø400	Ø500	886€
BV1-DWFTA04000550	Ø400	Ø550	983€
BV1-DWFTA04000600	Ø400	Ø600	1244€
BV1-DWFTA04000650	Ø400	Ø650	1619€
BV1-DWFTA04500500	Ø450	Ø500	808€
BV1-DWFTA04500550	Ø450	Ø550	940€
BV1-DWFTA04500600	Ø450	Ø600	1198€
BV1-DWFTA04500650	Ø450	Ø650	1552€
BV1-DWFTA04500700	Ø450	Ø700	1704€
BV1-DWFTA05000550	Ø500	Ø550	857€
BV1-DWFTA05000600	Ø500	Ø600	1144€
BV1-DWFTA05000650	Ø500	Ø650	1491€
BV1-DWFTA05000700	Ø500	Ø700	1636€
BV1-DWFTA05000750	Ø500	Ø750	1805€
BV1-DWFTA05500600	Ø550	Ø600	1040€
BV1-DWFTA05500650	Ø550	Ø650	1428€
BV1-DWFTA05500700	Ø550	Ø700	1572€
BV1-DWFTA05500750	Ø550	Ø750	1737€
BV1-DWFTA05500800	Ø550	Ø800	2020€
BV1-DWFTA06000650	Ø600	Ø650	1302€
BV1-DWFTA06000700	Ø600	Ø700	1504€
BV1-DWFTA06000750	Ø600	Ø750	1663€
BV1-DWFTA06000800	Ø600	Ø800	1944€
BV1-DWFTA06500700	Ø650	Ø700	1371€
BV1-DWFTA06500750	Ø650	Ø750	1593€
BV1-DWFTA06500800	Ø650	Ø800	1864€
BV1-DWFTA07000750	Ø700	Ø750	1454€
BV1-DWFTA07000800	Ø700	Ø800	1783€
BV1-DWFTA07500800	Ø750	Ø800	1627€



**REDUCCIÓN**

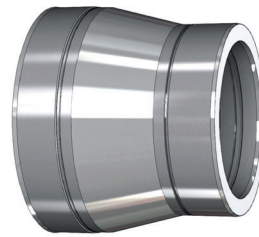
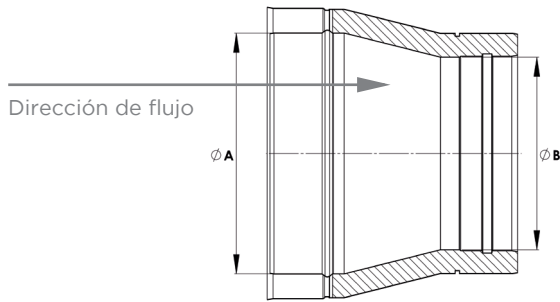

CÓDIGO	$\varnothing A$	$\varnothing B$	€
BV1-DWFTR01500130	Ø150	Ø130	166€
BV1-DWFTR01800130	Ø180	Ø130	217€
BV1-DWFTR01800150	Ø180	Ø150	198€
BV1-DWFTR02000130	Ø200	Ø130	281€
BV1-DWFTR02000150	Ø200	Ø150	273€
BV1-DWFTR02000180	Ø200	Ø180	249€
BV1-DWFTR03000250	Ø300	Ø250	357€
BV1-DWFTR03500250	Ø350	Ø250	468€
BV1-DWFTR03500300	Ø350	Ø300	428€
BV1-DWFTR04000250	Ø400	Ø250	592€
BV1-DWFTR04000300	Ø400	Ø300	573€
BV1-DWFTR04000350	Ø400	Ø350	525€
BV1-DWFTR04500250	Ø450	Ø250	842€
BV1-DWFTR04500300	Ø450	Ø300	810€
BV1-DWFTR04500350	Ø450	Ø350	781€
BV1-DWFTR04500400	Ø450	Ø400	711€
BV1-DWFTR05000250	Ø500	Ø250	990€
BV1-DWFTR05000300	Ø500	Ø300	955€
BV1-DWFTR05000350	Ø500	Ø350	922€
BV1-DWFTR05000400	Ø500	Ø400	882€
BV1-DWFTR05000450	Ø500	Ø450	804€
BV1-DWFTR05500300	Ø550	Ø300	1051€
BV1-DWFTR05500350	Ø550	Ø350	1014€
BV1-DWFTR05500400	Ø550	Ø400	975€
BV1-DWFTR05500450	Ø550	Ø450	933€

BV1-DWFTR05500500	Ø550	Ø500	854€
BV1-DWFTR06000350	Ø600	Ø350	1282€
BV1-DWFTR06000400	Ø600	Ø400	1233€
BV1-DWFTR06000450	Ø600	Ø450	1189€
BV1-DWFTR06000500	Ø600	Ø500	1138€
BV1-DWFTR06000550	Ø600	Ø550	1037€
BV1-DWFTR06500400	Ø650	Ø400	1603€
BV1-DWFTR06500450	Ø650	Ø450	1539€
BV1-DWFTR06500500	Ø650	Ø500	1481€
BV1-DWFTR06500550	Ø650	Ø550	1419€
BV1-DWFTR06500600	Ø650	Ø600	1297€
BV1-DWFTR07000450	Ø700	Ø450	1685€
BV1-DWFTR07000500	Ø700	Ø500	1620€
BV1-DWFTR07000550	Ø700	Ø550	1559€
BV1-DWFTR07000600	Ø700	Ø600	1494€
BV1-DWFTR07000650	Ø700	Ø650	1366€
BV1-DWFTR07500500	Ø750	Ø500	1784€
BV1-DWFTR07500550	Ø750	Ø550	1719€
BV1-DWFTR07500600	Ø750	Ø600	1649€
BV1-DWFTR07500650	Ø750	Ø650	1584€
BV1-DWFTR07500700	Ø750	Ø700	1450€
BV1-DWFTR08000550	Ø800	Ø550	2000€
BV1-DWFTR08000600	Ø800	Ø600	1926€
BV1-DWFTR08000650	Ø800	Ø650	1851€
BV1-DWFTR08000700	Ø800	Ø700	1776€
BV1-DWFTR08000750	Ø800	Ø750	1624€

## Conducto modular metálico con resistencia al fuego EI120 para ventilación de doble pared fabricado en acero inoxidable interior y exterior.

### MATERIAL

Pared Interior: Acero inoxidable  
Pared Exterior: Acero inoxidable

### ACABADO EXTERIOR

Brillante  
Exterior galvanizado/zincado: (sólo tramos rectos y desviaciones).  
11% descuento en exterior galva.

**Acabado galvanizado/zinc no apto para instalacion exterior.**

### AISLAMIENTO

Aislamiento mineral de alta densidad de 100 mm de espesor

### ESPEORES (mm)

Pared interior: 0,4 - 0,5 - 0,6 - 0,8 (según diámetro)

Aislamiento: 100 mm

Pared exterior: 0,4 - 0,5 - 0,6 - 0,8 (según diámetro)

### DIÁMETROS DISPONIBLES (mm)

Ø130 a Ø800

### SISTEMA DE UNIÓN

Conexión macho-hembra con **abrazadera de unión ancha (2.0)**

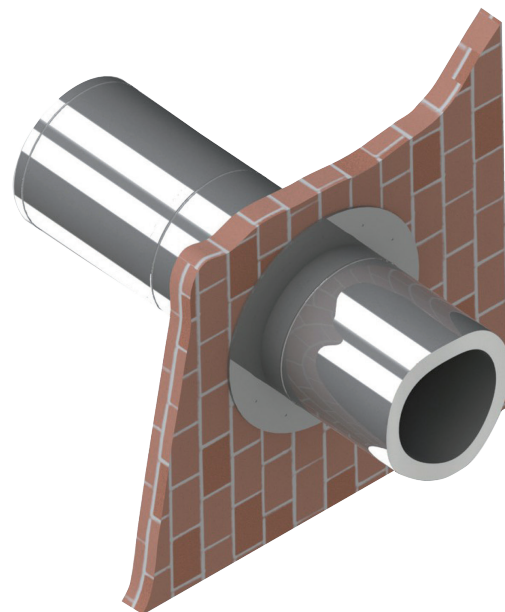

120°C

\*Sólo con junta



H1 5000 Pa



100 mm



### APLICACIONES

- Sectorización de zonas de incendio de riesgo alto
- Grupos electrógenos (*consultar opciones con menores aislamientos*)



### CARACTERÍSTICAS

- **Estanqueidad clase C según norma UNE-EN 12237** con la instalación de juntas de estanqueidad
- **Soldadura TIG/LASER** en continuo en todas las piezas
- **Abrazadera de unión incluida (excepto terminales)**

### CLASIFICACIONES EI (UNE-EN 13501-3)

EI 120 (ve i → o)

EI 120 (ho i → o)

EI 240 ve (o → i)

EI240 ho (o → i)



## Sistema SV - FT EI120-240



Módulo recto 1000mm



Módulo recto 500mm

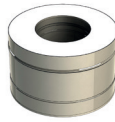

Módulo recto 250mm



Módulo recto regulable  
400-560mm



Módulo recto regulable  
560-920mm

150	BTI-DWFT130150	511€	150	BTI-DWFT140150	335€	150	BTI-DWFT150150	241€	150	BTI-DWFT5440150	467€	150	BTI-DWFT5450150	695€
180	BTI-DWFT130180	578€	180	BTI-DWFT140180	390€	180	BTI-DWFT150180	278€	180	BTI-DWFT5440180	545€	180	BTI-DWFT5450180	750€
200	BTI-DWFT130200	717€	200	BTI-DWFT140200	479€	200	BTI-DWFT150200	341€	200	BTI-DWFT5440200	664€	200	BTI-DWFT5450200	899€
250	BTI-DWFT130250	895€	250	BTI-DWFT140250	579€	250	BTI-DWFT150250	415€	250	BTI-DWFT5440250	820€	250	BTI-DWFT5450250	1104€
300	BTI-DWFT130300	940€	300	BTI-DWFT140300	637€	300	BTI-DWFT150300	458€	300	BTI-DWFT5440300	868€	300	BTI-DWFT5450300	1343€
350	BTI-DWFT130350	999€	350	BTI-DWFT140350	677€	350	BTI-DWFT150350	524€	350	BTI-DWFT5440350	960€	350	BTI-DWFT5450350	1423€
400	BTI-DWFT130400	1058€	400	BTI-DWFT140400	758€	400	BTI-DWFT150400	597€	400	BTI-DWFT5440400	1096€	400	BTI-DWFT5450400	1559€
450	BTI-DWFT130450	1168€	450	BTI-DWFT140450	811€	450	BTI-DWFT150450	675€	450	BTI-DWFT5440450	1215€	450	BTI-DWFT5450450	1652€
500	BTI-DWFT130500	1317€	500	BTI-DWFT140500	878€	500	BTI-DWFT150500	777€	500	BTI-DWFT5440500	1345€	500	BTI-DWFT5450500	1810€
550	BTI-DWFT130550	1455€	550	BTI-DWFT140550	1103€	550	BTI-DWFT150550	853€	550	BTI-DWFT5440550	1379€	550	BTI-DWFT5450550	1812€
600	BTI-DWFT130600	1531€	600	BTI-DWFT140600	1122€	600	BTI-DWFT150600	921€	600	BTI-DWFT5440600	1449€	600	BTI-DWFT5450600	2079€
650	BTI-DWFT130650	1660€	650	BTI-DWFT140650	1216€	650	BTI-DWFT150650	999€	650	BTI-DWFT5440650	1573€	650	BTI-DWFT5450650	2251€
700	BTI-DWFT130700	1790€	700	BTI-DWFT140700	1312€	700	BTI-DWFT150700	1075€	700	BTI-DWFT5440700	1698€	700	BTI-DWFT5450700	2426€
750	BTI-DWFT130750	1895€	750	BTI-DWFT140750	1393€	750	BTI-DWFT150750	1142€	750	BTI-DWFT5440750	1798€	750	BTI-DWFT5450750	2573€
800	BTI-DWFT130800	2121€	800	BTI-DWFT140800	1558€	800	BTI-DWFT150800	1277€	800	BTI-DWFT5440800	2012€	800	BTI-DWFT5450800	2879€

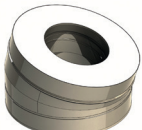

Codo 15°

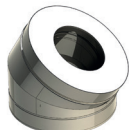

Codo 30°

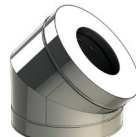

Codo 45°

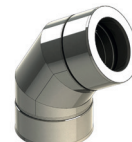

Codo 60°

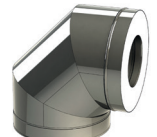

Codo 90°

150	BTI-DWFT160150	320€	150	BTI-DWFT170150	320€	150	BTI-DWFT180150	320€	150	BTI-DWFT840150	398€	150	BTI-DWFT600150	461€
180	BTI-DWFT160180	376€	180	BTI-DWFT170180	376€	180	BTI-DWFT180180	376€	180	BTI-DWFT840180	459€	180	BTI-DWFT600180	528€
200	BTI-DWFT160200	456€	200	BTI-DWFT170200	456€	200	BTI-DWFT180200	456€	200	BTI-DWFT840200	563€	200	BTI-DWFT600200	648€
250	BTI-DWFT160250	546€	250	BTI-DWFT170250	546€	250	BTI-DWFT180250	546€	250	BTI-DWFT840250	697€	250	BTI-DWFT600250	805€
300	BTI-DWFT160300	570€	300	BTI-DWFT170300	570€	300	BTI-DWFT180300	570€	300	BTI-DWFT840300	762€	300	BTI-DWFT600300	886€
350	BTI-DWFT160350	656€	350	BTI-DWFT170350	656€	350	BTI-DWFT180350	656€	350	BTI-DWFT840350	813€	350	BTI-DWFT600350	942€
400	BTI-DWFT160400	823€	400	BTI-DWFT170400	823€	400	BTI-DWFT180400	823€						
450	BTI-DWFT160450	1206€	450	BTI-DWFT170450	1206€	450	BTI-DWFT180450	1206€						
500	BTI-DWFT160500	1416€	500	BTI-DWFT170500	1416€	500	BTI-DWFT180500	1416€						
550	BTI-DWFT160550	1918€	550	BTI-DWFT170550	1918€	550	BTI-DWFT180550	1918€						
600	BTI-DWFT160600	2125€	600	BTI-DWFT170600	2125€	600	BTI-DWFT180600	2125€						
650	BTI-DWFT160650	2302€	650	BTI-DWFT170650	2302€	650	BTI-DWFT180650	2302€						
700	BTI-DWFT160700	2478€	700	BTI-DWFT170700	2478€	700	BTI-DWFT180700	2478€						
750	BTI-DWFT160750	2629€	750	BTI-DWFT170750	2629€	750	BTI-DWFT180750	2629€						
800	BTI-DWFT160800	2944€	800	BTI-DWFT170800	2944€	800	BTI-DWFT180800	2944€						



Te 90°



Te 135°



Colector de hollín aislado

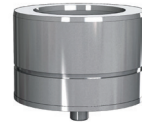

Colector de hollín con  
desagüe aislado



Módulo de inspección con  
tapa 200 Pa (P1)

150	BTI-DWFT3170150	673€	150	BTI-DWFT120150	1030€	150	825-DWFT20330150	250€	150	825-DWFT14600150	283€	150	BTI-DWFT5490150	573€
180	BTI-DWFT3170180	793€	180	BTI-DWFT120180	1234€	180	825-DWFT20330180	272€	180	825-DWFT14600180	304€	180	BTI-DWFT5490180	604€
200	BTI-DWFT3170200	982€	200	BTI-DWFT120200	1465€	200	825-DWFT20330200	334€	200	825-DWFT14600200	366€	200	BTI-DWFT5490200	633€
250	BTI-DWFT3170250	1216€	250	BTI-DWFT120250	1820€	250	825-DWFT20330250	348€	250	825-DWFT14600250	413€	250	BTI-DWFT5490250	677€
300	BTI-DWFT3170300	1343€	300	BTI-DWFT120300	1997€	300	825-DWFT20330300	357€	300	825-DWFT14600300	542€	300	BTI-DWFT5490300	737€
350	BTI-DWFT3170350	1417€	350	BTI-DWFT120350	2115€	350	825-DWFT20330350	365€	350	825-DWFT14600350	527€	350	BTI-DWFT5490350	791€
400	BTI-DWFT3170400	1771€	400	BTI-DWFT120400	2949€	400	825-DWFT20330400	369€	400	825-DWFT14600400	533€	400	BTI-DWFT5490400	1119€
450	BTI-DWFT3170450	2056€	450	BTI-DWFT120450	3205€	450	825-DWFT20330450	420€	450	825-DWFT14600450	637€	450	BTI-DWFT5490450	1215€
500	BTI-DWFT3170500	2537€	500	BTI-DWFT120500	3460€	500	825-DWFT20330500	533€	500	825-DWFT14600500	821€	500	BTI-DWFT5490500	1289€
550	BTI-DWFT3170550	2681€	550	BTI-DWFT120550	4141€	550	825-DWFT20330550	603€	550	825-DWFT14600550	955€	550	BTI-DWFT5490550	1366€
600	BTI-DWFT3170600	3084€	600	BTI-DWFT120600	4287€	600	825-DWFT20330600	717€	600	825-DWFT14600600	929€	600	BTI-DWFT5490600	1449€
650	BTI-DWFT3170650	3343€	650	BTI-DWFT120650	4645€	650	825-DWFT20330650	739€	650	825-DWFT14600650	1003€	650	BTI-DWFT5490650	1626€
700	BTI-DWFT3170700	3604€	700	BTI-DWFT120700	5007€	700	825-DWFT20330700	753€	700	825-DWFT14600700	1080€	700	BTI-DWFT5490700	1754€
750	BTI-DWFT3170750	3821€	750	BTI-DWFT120750	5306€	750	825-DWFT20330750	798€	750	825-DWFT14600750	1142€	750	BTI-DWFT5490750	1834€
800	BTI-DWFT3170800	4279€	800	BTI-DWFT120800	5938€	800	825-DWFT20330800	896€	800	825-DWFT14600800	1282€	800	BTI-DWFT5490800	1922€

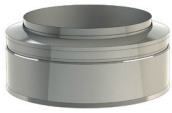

Terminal salida libre

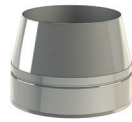

Terminal salida cónica



Terminal anti-lluvia



Terminal anti-viento



Terminal horizontal con  
rejilla

150	BTI-DWFT320150	196€	150	BTI-DWFT32C0150	226€	150	BTI-DWFT5260150	275€	150	BTI-DWFT5270150	392€	150	BTI-DWFT5320150	272€
180	BTI-DWFT320180	229€	180	BTI-DWFT32C0180	261€	180	BTI-DWFT5260180	315€	180	BTI-DWFT5270180	454€	180	BTI-DWFT5320180	313€
200	BTI-DWFT320200	282€	200	BTI-DWFT32C0200	327€	200	BTI-DWFT5260200	386€	200	BTI-DWFT5270200	556€	200	BTI-DWFT5320200	389€
250	BTI-DWFT320250	349€	250	BTI-DWFT32C0250	401€	250	BTI-DWFT5260250	482€	250	BTI-DWFT5270250	686€	250	BTI-DWFT5320250	482€
300	BTI-DWFT320300	385€	300	BTI-DWFT32C0300	443€	300	BTI-DWFT5260300	535€	300	BTI-DWFT5270300	758€	300	BTI-DWFT5320300	523€
350	BTI-DWFT320350	408€	350	BTI-DWFT32C0350	466€	350	BTI-DWFT5260350	563€	350	BTI-DWFT5270350	800€	350	BTI-DWFT5320350	596€
400	BTI-DWFT320400	509€	400	BTI-DWFT32C0400	581€	400	BTI-DWFT5260400	705€	400	BTI-DWFT5270400	833€	400	BTI-DWFT5320400	661€
450	BTI-DWFT320450	567€	450	BTI-DWFT32C0450	648€	450	BTI-DWFT5260450	1042€				450	BTI-DWFT5320450	998€
500	BTI-DWFT320500	647€	500	BTI-DWFT32C0500	739€	500	BTI-DWFT5260500	1058€				500	BTI-DWFT5320500	1092€
550	BTI-DWFT320550	664€	550	BTI-DWFT32C0550	762€	550	BTI-DWFT5260550	1192€				550	BTI-DWFT5320550	1498€
600	BTI-DWFT320600	685€	600	BTI-DWFT32C0600	783€	600	BTI-DWFT5260600	1211€				600	BTI-DWFT5320600	1563€
650	BTI-DWFT320650	702€	650	BTI-DWFT32C0650	801€							650	BTI-DWFT5320650	1693€
700	BTI-DWFT320700	755€	700	BTI-DWFT32C0700	867€							700	BTI-DWFT5320700	1825€
750	BTI-DWFT320750	808€	750	BTI-DWFT32C0750	922€							750	BTI-DWFT5320750	1933€
800	BTI-DWFT320800	900€	800	BTI-DWFT32C0800	1026€							800	BTI-DWFT5320800	2159€



# Sistema SV - FT EI120-240

Consultar página 91 para ver distancias de separación.



Terminal JET

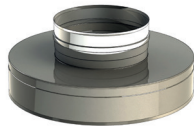

Adaptador doble a simple

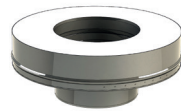

Adaptador simple a doble

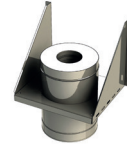

Soporte de carga regulable



Pasamuros EI

150	BTI-DWFT340150	1123€	150	BTI-DWFT37A0150	128€	150	BTI-DWFT370150	128€	150	BTI-DWFT3790150	540€	150	BTI-DWFT43300150	727€
180	BTI-DWFT340180	1237€	180	BTI-DWFT37A0180	136€	180	BTI-DWFT370180	136€	180	BTI-DWFT3790180	631€	180	BTI-DWFT43300180	789€
200	BTI-DWFT340200	1269€	200	BTI-DWFT37A0200	146€	200	BTI-DWFT370200	146€	200	BTI-DWFT3790200	771€	200	BTI-DWFT43300200	846€
250	BTI-DWFT340250	1532€	250	BTI-DWFT37A0250	164€	250	BTI-DWFT370250	164€	250	BTI-DWFT3790250	954€	250	BTI-DWFT43300250	957€
300	BTI-DWFT340300	2029€	300	BTI-DWFT37A0300	176€	300	BTI-DWFT370300	176€	300	BTI-DWFT3790300	1049€	300	BTI-DWFT43300300	1065€
350	BTI-DWFT340350	2182€	350	BTI-DWFT37A0350	197€	350	BTI-DWFT370350	197€	350	BTI-DWFT3790350	1114€	350	BTI-DWFT43300350	1197€
400	BTI-DWFT340400	2452€	400	BTI-DWFT37A0400	205€	400	BTI-DWFT370400	205€	400	BTI-DWFT3790400	1389€	400	BTI-DWFT43300400	1342€
450	BTI-DWFT340450	3043€	450	BTI-DWFT37A0450	264€	450	BTI-DWFT370450	264€	450	BTI-DWFT3790450	1550€	450	BTI-DWFT43300450	1513€
500	BTI-DWFT340500	3265€	500	BTI-DWFT37A0500	340€	500	BTI-DWFT370500	340€	500	BTI-DWFT3790500	1771€	500	BTI-DWFT43300500	1663€
550	BTI-DWFT340550	3963€	550	BTI-DWFT37A0550	410€	550	BTI-DWFT370550	410€	550	BTI-DWFT3790550	1971€	550	BTI-DWFT43300550	1792€
600	BTI-DWFT340600	4301€	600	BTI-DWFT37A0600	418€	600	BTI-DWFT370600	418€	600	BTI-DWFT3790600	2056€	600	BTI-DWFT43300600	1931€
650	BTI-DWFT340650	4660€	650	BTI-DWFT37A0650	454€	650	BTI-DWFT370650	454€	650	BTI-DWFT3790650	2229€	650	BTI-DWFT43300650	2073€
700	BTI-DWFT340700	5019€	700	BTI-DWFT37A0700	493€	700	BTI-DWFT370700	493€	700	BTI-DWFT3790700	2401€	700	BTI-DWFT43300700	2216€
750	BTI-DWFT340750	5317€	750	BTI-DWFT37A0750	521€	750	BTI-DWFT370750	521€	750	BTI-DWFT3790750	2550€	750	BTI-DWFT43300750	2377€
800	BTI-DWFT340800	5955€	800	BTI-DWFT37A0800	582€	800	BTI-DWFT370800	582€	800	BTI-DWFT3790800	2850€	800	BTI-DWFT43300800	2508€

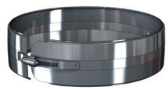

Abrazadera de unión 2.0



Abrazadera fijación pared regulable 50-80mm



Abrazadera fijación pared fija



Base de abrazadera distanciadora



Alas distanciadoras A

150	665-ZUWA9890350	34.15€	150	665-ZUWA5560350	67€	300	665-ZUWA556F0500	123€	150	665-ZUWA14620350	185€	150	665-ZUWA1462A	47.13€
180	665-ZUWA9890380	40.87€	180	665-ZUWA5560380	84€	350	665-ZUWA556F0550	155€	180	665-ZUWA14620380	221€	180	665-ZUWA1462A	47.13€
200	665-ZUWA9890400	42.42€	200	665-ZUWA5560400	88€	400	665-ZUWA556F0600	185€	200	665-ZUWA14620400	241€	200	665-ZUWA1462A	47.13€
250	665-ZUWA9890450	48.72€	250	665-ZUWA5560450	98€	450	665-ZUWA556F0650	203€	250	665-ZUWA14620450	298€	250	665-ZUWA1462A	47.13€
300	665-ZUWA9890500	54€				500	665-ZUWA556F0700	264€	300	665-ZUWA14620500	328€	300	665-ZUWA1462A	47.13€
350	665-ZUWA9890550	58€				550	665-ZUWA556F0750	321€	350	665-ZUWA14620550	365€	350	665-ZUWA1462A	47.13€
400	665-ZUWA9890600	66€				600	665-ZUWA556F0800	358€	400	665-ZUWA14620600	412€	400	665-ZUWA1462A	47.13€
450	665-ZUWA9890650	73€				650	665-ZUWA556F0850	379€	450	665-ZUWA14620650	444€	450	665-ZUWA1462A	47.13€
500	665-ZUWA9890700	84€				700	665-ZUWA556F0900	404€	500	665-ZUWA14620700	572€	500	665-ZUWA1462A	47.13€
550	665-ZUWA9890750	100€				750	665-ZUWA556F0950	438€	550	665-ZUWA14620750	587€	550	665-ZUWA1462A	47.13€
600	665-ZUWA9890800	111€				800	665-ZUWA556F1000	473€	600	665-ZUWA14620800	786€	600	665-ZUWA1462A	47.13€
650	665-ZUWA9890850	119€							650	665-ZUWA14620850	837€	650	665-ZUWA1462A	47.13€
700	665-ZUWA9890900	129€							700	665-ZUWA14620900	886€	700	665-ZUWA1462A	47.13€
750	665-ZUWA9890950	139€							750	665-ZUWA14620950	961€	750	665-ZUWA1462A	47.13€
800	665-ZUWA9891000	150€							800	665-ZUWA14621000	1034€	800	665-ZUWA1462A	47.13€



Alas distanciadoras B



Alas distanciadoras C



Alas distanciadoras D



Abrazadera de soporte



Abrazadera con doble pértiga telescópica L=2000mm

150	665-ZUWA1462B	65€	150	665-ZUWA1462C	81€	150	665-ZUWA1462D	104€	150	665-ZUWA8580350	221€	150	665-ZUWA1910350	249€
180	665-ZUWA1462B	65€	180	665-ZUWA1462C	81€	180	665-ZUWA1462D	104€	180	665-ZUWA8580380	268€	180	665-ZUWA1910380	272€
200	665-ZUWA1462B	65€	200	665-ZUWA1462C	81€	200	665-ZUWA1462D	104€	200	665-ZUWA8580400	270€	200	665-ZUWA1910400	272€
250	665-ZUWA1462B	65€	250	665-ZUWA1462C	81€	250	665-ZUWA1462D	104€	250	665-ZUWA8580450	321€	250	665-ZUWA1910450	380€
300	665-ZUWA1462B	65€	300	665-ZUWA1462C	81€	300	665-ZUWA1462D	104€	300	665-ZUWA8580500	354€	300	665-ZUWA1910500	496€
350	665-ZUWA1462B	65€	350	665-ZUWA1462C	81€	350	665-ZUWA1462D	104€	350	665-ZUWA8580550	401€	350	665-ZUWA1910550	647€
400	665-ZUWA1462B	65€	400	665-ZUWA1462C	81€	400	665-ZUWA1462D	104€	400	665-ZUWA8580600	454€	400	665-ZUWA1910600	699€
450	665-ZUWA1462B	65€	450	665-ZUWA1462C	81€	450	665-ZUWA1462D	104€	450	665-ZUWA8580650	492€	450	665-ZUWA1910650	766€
500	665-ZUWA1462B	65€	500	665-ZUWA1462C	81€	500	665-ZUWA1462D	104€	500	665-ZUWA8580700	637€	500	665-ZUWA1910700	871€
550	665-ZUWA1462B	65€	550	665-ZUWA1462C	81€	550	665-ZUWA1462D	104€	550	665-ZUWA8580750	780€	550	665-ZUWA1910750	976€
600	665-ZUWA1462B	65€	600	665-ZUWA1462C	81€	600	665-ZUWA1462D	104€	600	665-ZUWA8580800	870€	600	665-ZUWA1910800	1127€
650	665-ZUWA1462B	65€	650	665-ZUWA1462C	81€	650	665-ZUWA1462D	104€	650	665-ZUWA8580850	929€	650	665-ZUWA1910850	1199€
700	665-ZUWA1462B	65€	700	665-ZUWA1462C	81€	700	665-ZUWA1462D	104€	700	665-ZUWA8580900	984€	700	665-ZUWA1910900	1267€
750	665-ZUWA1462B	65€	750	665-ZUWA1462C	81€	750	665-ZUWA1462D	104€	750	665-ZUWA8580950	1066€	750	665-ZUWA1910950	1380€
800	665-ZUWA1462B	65€	800	665-ZUWA1462C	81€	800	665-ZUWA1462D	104€	800	665-ZUWA8581000	1153€	800	665-ZUWA1911000	1490€



Abrazadera forjado inox



Abrazadera vientos



Collarín antitormenta

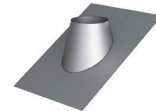

Cubreaguas 25°-45° aluminio

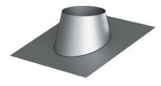

Cubreaguas 5°-25° aluminio

150	665-ZUWA620350	66€	150	665-ZUWA420350	37.43€	150	665-ZUWA3070350	77€	150	665-ZUWA939AL0350	387€	150	665-ZUWA938AL0350	351€
180	665-ZUWA620380	74€	180	665-ZUWA420380	40.87€	180	665-ZUWA3070380	83€	180	665-ZUWA939AL0380	433€	180	665-ZUWA938AL0380	390€
200	665-ZUWA620400	74€	200	665-ZUWA420400	40.87€	200	665-ZUWA3070400	83€	200	665-ZUWA939AL0400	433€	200	665-ZUWA938AL0400	390€
250	665-ZUWA620450	83€	250	665-ZUWA420450	56€	250	665-ZUWA3070450	114€	250	665-ZUWA939AL0450	492€	250	665-ZUWA938AL0450	436€
300	665-ZUWA620500	96€	300	665-ZUWA420500	74€	300	665-ZUWA3070500	151€	300	665-ZUWA939AL0500	549€	300	665-ZUWA938AL0500	488€
350	665-ZUWA620550	103€	350	665-ZUWA420550	98€	350	665-ZUWA3070550	199€	350	665-ZUWA939AL0550	607€	350	665-ZUWA938AL0550	524€
400	665-ZUWA620600	109€	400	665-ZUWA420600	106€	400	665-ZUWA3070600	211€	400	665-ZUWA939AL0600	661€	400	665-ZUWA938AL0600	573€
450	665-ZUWA620650	115€	450	665-ZUWA420650	114€	450	665-ZUWA3070650	234€	450	665-ZUWA939AL0650	730€	450	665-ZUWA938AL0650	618€
500	665-ZUWA620700	122€	500	665-ZUWA420700	151€	500	665-ZUWA3070700	268€	500	665-ZUWA939AL0700	840€	500	665-ZUWA938AL0700	679€
550	665-ZUWA620750	130€	550	665-ZUWA420750	185€	550	665-ZUWA3070750	296€	550	665-ZUWA939AL0750	939€	550	665-ZUWA938AL0750	736€
600	665-ZUWA620800	136€	600	665-ZUWA420800	204€	600	665-ZUWA3070800	343€	600	665-ZUWA939AL0800	1123€	600	665-ZUWA938AL0800	880€
			650	665-ZUWA420850	218€	650	665-ZUWA3070850	365€	650	665-ZUWA939AL0850	1271€	650	665-ZUWA938AL0850	1015€
			700	665-ZUWA420900	232€	700	665-ZUWA3070900	387€	700	665-ZUWA939AL0900	1348€	700	665-ZUWA938AL0900	1100€
			750	665-ZUWA420950	249€	750	665-ZUWA3070950	417€	750	665-ZUWA939AL0950	1422€	750	665-ZUWA938AL0950	1135€
			800	665-ZUWA421000	270€	800	665-ZUWA3071000	454€	800	665-ZUWA939AL1000	1499€	800	665-ZUWA938AL1000	1188€



# Sistema SV-FT EI120-240

Necesario instalar el elemento de cubreaguas.

Consultar página 91 para ver distancias de separación.

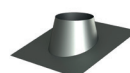
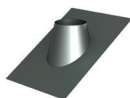
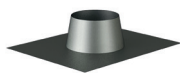
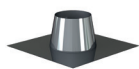

Cubreaguas plano inox

Cubreaguas plomo 0°-5°

Cubreaguas plomo 25°-45°

Cubreaguas plomo 5°-25°

150	665-ZUWA11280350	260€	150	665-ZUWA9370350	361€	150	665-ZUWA9390350	431€	150	665-ZUWA9380350	361€
180	665-ZUWA11280380	275€	180	665-ZUWA9370380	386€	180	665-ZUWA9390380	447€	180	665-ZUWA9380380	386€
200	665-ZUWA11280400	286€	200	665-ZUWA9370400	396€	200	665-ZUWA9390400	454€	200	665-ZUWA9380400	396€
250	665-ZUWA11280450	306€	250	665-ZUWA9370450	428€	250	665-ZUWA9390450	541€	250	665-ZUWA9380450	428€
300	665-ZUWA11280500	352€	300	665-ZUWA9370500	488€	300	665-ZUWA9390500	618€	300	665-ZUWA9380500	488€
350	665-ZUWA11280550	389€	350	665-ZUWA9370550	539€	350	665-ZUWA9390550	691€	350	665-ZUWA9380550	539€
400	665-ZUWA11280600	437€	400	665-ZUWA9370600	606€	400	665-ZUWA9390600	775€	400	665-ZUWA9380600	606€
450	665-ZUWA11280650	492€	450	665-ZUWA9370650	684€	450	665-ZUWA9390650	869€	450	665-ZUWA9380650	684€
500	665-ZUWA11280700	551€	500	665-ZUWA9370700	763€	500	665-ZUWA9390700	971€	500	665-ZUWA9380700	763€
550	665-ZUWA11280750	587€	550	665-ZUWA9370750	815€	550	665-ZUWA9390750	1034€	550	665-ZUWA9380750	815€
600	665-ZUWA11280800	614€	600	665-ZUWA9370800	850€	600	665-ZUWA9390800	1082€	600	665-ZUWA9380800	850€
650	665-ZUWA11280850	652€	650	665-ZUWA9370850	902€	650	665-ZUWA9390850	1151€	650	665-ZUWA9380850	902€
700	665-ZUWA11280900	688€	700	665-ZUWA9370900	955€	700	665-ZUWA9390900	1215€	700	665-ZUWA9380900	955€
750	665-ZUWA11280950	750€	750	665-ZUWA9370950	1037€	750	665-ZUWA9390950	1318€	750	665-ZUWA9380950	1037€
800	665-ZUWA11281000	806€	800	665-ZUWA9371000	1122€	800	665-ZUWA9391000	1424€	800	665-ZUWA9381000	1122€

## AMPLIACIÓN

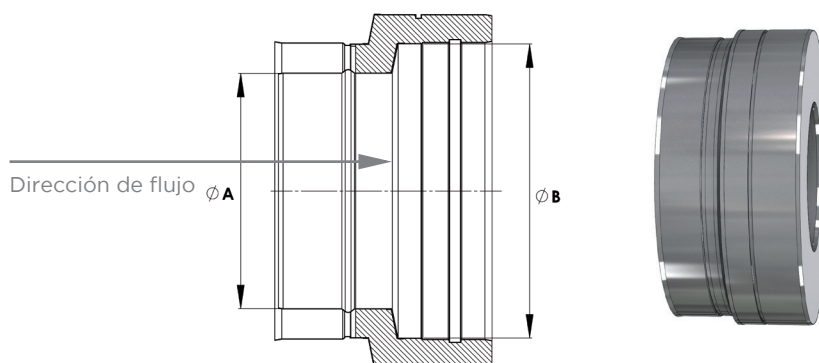

CÓDIGO	Ø A	Ø B	€
BT1-DWFTA01000150	Ø100	Ø150	208€
BT1-DWFTA01000180	Ø100	Ø180	261€
BT1-DWFTA01000200	Ø100	Ø200	340€
BT1-DWFTA01000250	Ø100	Ø250	436€
BT1-DWFTA01300150	Ø130	Ø150	190€
BT1-DWFTA01300180	Ø130	Ø180	252€
BT1-DWFTA01300200	Ø130	Ø200	327€
BT1-DWFTA01300250	Ø130	Ø250	426€
BT1-DWFTA01300300	Ø130	Ø300	514€
BT1-DWFTA01500180	Ø150	Ø180	229€
BT1-DWFTA01500200	Ø150	Ø200	308€
BT1-DWFTA01500250	Ø150	Ø250	406€
BT1-DWFTA01500300	Ø150	Ø300	490€
BT1-DWFTA01500350	Ø150	Ø350	610€
BT1-DWFTA01500400	Ø150	Ø400	769€
BT1-DWFTA01800200	Ø180	Ø200	281€
BT1-DWFTA01800250	Ø180	Ø250	389€
BT1-DWFTA01800300	Ø180	Ø300	472€
BT1-DWFTA01800350	Ø180	Ø350	587€
BT1-DWFTA01800400	Ø180	Ø400	744€
BT1-DWFTA02000250	Ø200	Ø250	355€
BT1-DWFTA02000300	Ø200	Ø300	448€
BT1-DWFTA02000350	Ø200	Ø350	562€
BT1-DWFTA02000400	Ø200	Ø400	719€
BT1-DWFTA02000450	Ø200	Ø450	1014€
BT1-DWFTA02500300	Ø250	Ø300	410€
BT1-DWFTA02500350	Ø250	Ø350	538€
BT1-DWFTA02500400	Ø250	Ø400	686€
BT1-DWFTA02500450	Ø250	Ø450	967€
BT1-DWFTA02500500	Ø250	Ø500	1147€
BT1-DWFTA03000350	Ø300	Ø350	492€
BT1-DWFTA03000400	Ø300	Ø400	658€
BT1-DWFTA03000450	Ø300	Ø450	931€
BT1-DWFTA03000500	Ø300	Ø500	1101€
BT1-DWFTA03000550	Ø300	Ø550	1210€

BT1-DWFTA03500400	Ø350	Ø400	597€
BT1-DWFTA03500450	Ø350	Ø450	894€
BT1-DWFTA03500500	Ø350	Ø500	1052€
BT1-DWFTA03500550	Ø350	Ø550	1167€
BT1-DWFTA03500600	Ø350	Ø600	1479€
BT1-DWFTA04000450	Ø400	Ø450	814€
BT1-DWFTA04000500	Ø400	Ø500	1015€
BT1-DWFTA04000550	Ø400	Ø550	1120€
BT1-DWFTA04000600	Ø400	Ø600	1420€
BT1-DWFTA04000650	Ø400	Ø650	1850€
BT1-DWFTA04500500	Ø450	Ø500	920€
BT1-DWFTA04500550	Ø450	Ø550	1068€
BT1-DWFTA04500600	Ø450	Ø600	1363€
BT1-DWFTA04500650	Ø450	Ø650	1774€
BT1-DWFTA04500700	Ø450	Ø700	1945€
BT1-DWFTA05000550	Ø500	Ø550	974€
BT1-DWFTA05000600	Ø500	Ø600	1305€
BT1-DWFTA05000650	Ø500	Ø650	1703€
BT1-DWFTA05000700	Ø500	Ø700	1873€
BT1-DWFTA05000750	Ø500	Ø750	2062€
BT1-DWFTA05500600	Ø550	Ø600	1192€
BT1-DWFTA05500650	Ø550	Ø650	1632€
BT1-DWFTA05500700	Ø550	Ø700	1793€
BT1-DWFTA05500750	Ø550	Ø750	1982€
BT1-DWFTA05500800	Ø550	Ø800	2308€
BT1-DWFTA06000650	Ø600	Ø650	1485€
BT1-DWFTA06000700	Ø600	Ø700	1717€
BT1-DWFTA06000750	Ø600	Ø750	1900€
BT1-DWFTA06000800	Ø600	Ø800	2219€
BT1-DWFTA06500700	Ø650	Ø700	1563€
BT1-DWFTA06500750	Ø650	Ø750	1819€
BT1-DWFTA06500800	Ø650	Ø800	2127€
BT1-DWFTA07000750	Ø700	Ø750	1658€
BT1-DWFTA07000800	Ø700	Ø800	2038€
BT1-DWFTA07500800	Ø750	Ø800	1855€



REDUCCIÓN

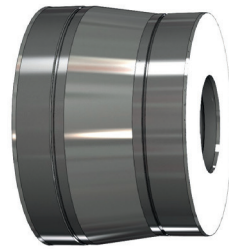
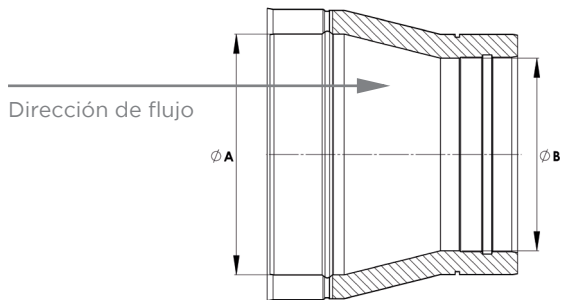

CÓDIGO	Ø A	Ø B	€
BT1-DWFTR01800150	Ø180	Ø150	246€
BT1-DWFTR02000150	Ø200	Ø150	335€
BT1-DWFTR02000180	Ø200	Ø180	306€
BT1-DWFTR02500150	Ø250	Ø150	439€
BT1-DWFTR02500180	Ø250	Ø180	423€
BT1-DWFTR02500200	Ø250	Ø200	384€
BT1-DWFTR03000250	Ø300	Ø250	439€
BT1-DWFTR03000150	Ø300	Ø150	526€
BT1-DWFTR03000180	Ø300	Ø180	508€
BT1-DWFTR03000200	Ø300	Ø200	485€
BT1-DWFTR03500250	Ø350	Ø250	573€
BT1-DWFTR03500300	Ø350	Ø300	524€
BT1-DWFTR03500150	Ø350	Ø150	657€
BT1-DWFTR03500180	Ø350	Ø180	630€
BT1-DWFTR03500200	Ø350	Ø200	608€
BT1-DWFTR04000250	Ø400	Ø250	732€
BT1-DWFTR04000300	Ø400	Ø300	705€
BT1-DWFTR04000350	Ø400	Ø350	644€
BT1-DWFTR04000180	Ø400	Ø180	803€
BT1-DWFTR04000200	Ø400	Ø200	775€
BT1-DWFTR04500250	Ø450	Ø250	1036€
BT1-DWFTR04500300	Ø450	Ø300	996€
BT1-DWFTR04500350	Ø450	Ø350	958€
BT1-DWFTR04500400	Ø450	Ø400	876€
BT1-DWFTR04500200	Ø450	Ø200	1090€
BT1-DWFTR05000250	Ø500	Ø250	1225€
BT1-DWFTR05000300	Ø500	Ø300	1178€
BT1-DWFTR05000350	Ø500	Ø350	1132€
BT1-DWFTR05000400	Ø500	Ø400	1086€
BT1-DWFTR05000450	Ø500	Ø450	991€
BT1-DWFTR05500300	Ø550	Ø300	1296€
BT1-DWFTR05500350	Ø550	Ø350	1247€
BT1-DWFTR05500400	Ø550	Ø400	1199€
BT1-DWFTR05500450	Ø550	Ø450	1148€
BT1-DWFTR05500500	Ø550	Ø500	1050€

BT1-DWFTR06000350	Ø600	Ø350	1583€
BT1-DWFTR06000400	Ø600	Ø400	1533€
BT1-DWFTR06000450	Ø600	Ø450	1460€
BT1-DWFTR06000500	Ø600	Ø500	1401€
BT1-DWFTR06000550	Ø600	Ø550	1277€
BT1-DWFTR06500400	Ø650	Ø400	1980€
BT1-DWFTR06500450	Ø650	Ø450	1900€
BT1-DWFTR06500500	Ø650	Ø500	1827€
BT1-DWFTR06500550	Ø650	Ø550	1752€
BT1-DWFTR06500600	Ø650	Ø600	1597€
BT1-DWFTR07000450	Ø700	Ø450	2080€
BT1-DWFTR07000500	Ø700	Ø500	2001€
BT1-DWFTR07000550	Ø700	Ø550	1918€
BT1-DWFTR07000600	Ø700	Ø600	1840€
BT1-DWFTR07000650	Ø700	Ø650	1681€
BT1-DWFTR07500500	Ø750	Ø500	2201€
BT1-DWFTR07500550	Ø750	Ø550	2121€
BT1-DWFTR07500600	Ø750	Ø600	2038€
BT1-DWFTR07500650	Ø750	Ø650	1953€
BT1-DWFTR07500700	Ø750	Ø700	1787€
BT1-DWFTR08000550	Ø800	Ø550	2469€
BT1-DWFTR08000600	Ø800	Ø600	2374€
BT1-DWFTR08000650	Ø800	Ø650	2282€
BT1-DWFTR08000700	Ø800	Ø700	2186€
BT1-DWFTR08000750	Ø800	Ø750	2001€



## Índice

DW-ECO 1.0 316 SCHWARZ	150
FERRO-LUX	155
EW-VITRO	159
LINE-FLEX	161
TWIN-BIOMASS NEGRO	163
EW-PELLETS NEGRO	167
EW-PELLETS INOX	171
VITRO-PELLETS	173
Accesorios	175

# Biomasa



# 147



**JEREMIAS** dispone de una completa gama de soluciones de **evacuación de humos** para todas los diferentes tipos de **instalaciones de biomasa** (estufas de pellets y maderas, fuegos bajos, calderas de biomasa, cassettes, entubados de chimeneas de obra, etc).



En las instalaciones de aparatos de biomasa y especialmente en aparatos que operan en tiro natural, aparte de hacer un buen cálculo de dimensionamiento que asegure el diámetro óptimo para el correcto funcionamiento, es fundamental respetar la normativa de distancias mínimas a material combustible. Jeremias ofrece una amplia gama de sistemas de doble pared aislada que han pasado todas las pruebas necesarias para garantizar el funcionamiento del sistema y que avalan la calidad del aislamiento rígido de lana de roca exclusivo de Jeremias. La gama se completa con numerosos accesorios que facilitan la instalación de los sistemas de acuerdo a la normativa vigente.

	Gas natural	Gasoil	Comb. Sólidos	Condensación	Condiciones húmedas	Temperatura (°C)	Material interior	Material exterior	Espesor mat. Interior (mm)	N=tiro natural P= sobrepresión H=altas presiones	Resist. fuego de hollín
EW-PELLETS	-	-	●	-	-	200	AISI 316L	-	0.4	N	●
TWIN-BIOMASS	-	-	●	-	-	450	AISI 316L	AISI 304	0.4	N	●
	-	-	●	-	-	600	AISI 316L	AISI 304	0.16 0.2	N	●
LINE-FLEX	-	●	●	-	●	600	AISI 316L	AISI 304	0.16 0.2	N	-
	●	-	-	●	●	200	AISI 316L	AISI 304	0.16 0.2	P	-
FERRO-LUX	-	-	●	-	-	600	Acero DC01	-	2	N	●
EW-VITRO	-	-	●	-	-	600	Acero vitrificado	-	1.1	N	●



## Chimeneas pa

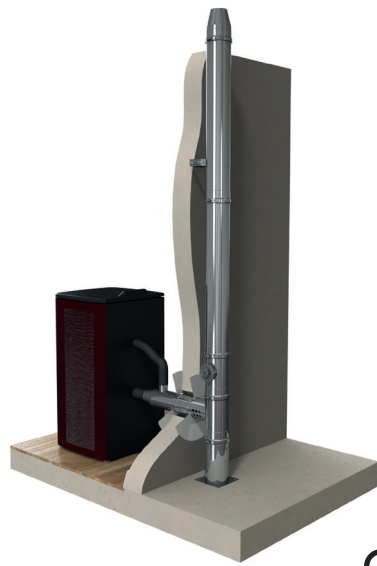

CE

**DW-ECO 1.0 316**   OTROS

Sistema de doble pared fabricado en acero inoxidable interior y exterior con aislamiento intermedio de lana de roca rígida, que nos permite evitar cualquier puente térmico entre pared interior y exterior, además de la posibilidad de cortar a medida los tramos rectos en la propia instalación (una ventaja enorme para la instalación en las condiciones más complicadas). PAG. 40



CE

**FERRO-LUX** 

Sistema fabricado en acero de 2 mm de espesor y pintado en negro con pintura específica para altas temperaturas. Se utiliza para las salidas de fuegos bajos y para estufas de madera (con temperaturas de hasta 600°C). Al igual que el EW-PELLETS, debe utilizarse en combinación con otros sistemas al salir de la sala. PAG. 202



**EW-PELLETS**  CE

Sistema de simple pared con acabados en inoxidable y pintado en negro. Es el ideal para las estufas de pellets (por debajo de 200°C) para poder aprovechar el calor de los humos antes de que salgan de la sala. Se debe combinar con otros productos al salir de la sala (por ejemplo DW-ECO 316) si no va directamente a descargar al exterior tras la pared. PAG. 192



**TWIN-BIOMASS**  CE

Sistema de chimenea de doble pared concéntrica para la evacuación de humos y toma de aire de forma equilibrada.

Especialmente diseñada para las estufas de pellets de cámara de combustión estanca en instalaciones de casas pasivas garantizando una eficiencia energética alta. PAG. 196



**LINE-FLEX**  CE

Sistema de chimenea flexible de doble capa ideal para entubados donde no sea posible el uso de chimenea rígida. Dispone de numerosos accesorios de conexión con otros sistemas con los que se puede combinar (DW-ECO, FERRO-LUX, etc.) y de elementos de terminación. PAG. 200



**Chimenea modular metálica para evacuación de humos y gases de los productos de la combustión de doble pared fabricada en acero inoxidable interior y exterior.**

## MATERIAL

Pared Interior: AISI 316L

Pared Exterior: AISI 304

## ACABADO EXTERIOR

Pintura exterior negra (RAL 9005).

## AISLAMIENTO

Lana de roca rígida de alta densidad (120kg/m<sup>3</sup>)

## ESPESORES (mm)

Pared interior: 0,4 mm

Aislamiento: 25 mm

Pared exterior: 0,4 mm

## DIÁMETROS DISPONIBLES (mm)

Ø80 a Ø200

## SISTEMA DE UNIÓN

Conexión macho-hembra con **abrazadera de unión sencilla**

## NIVEL DE ESTANQUEIDAD

Txxx - N1: Sin necesidad de junta

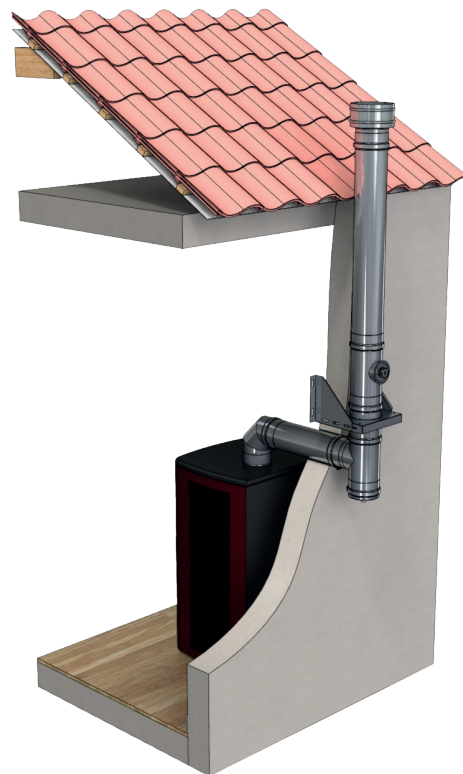

## APLICACIONES

- Calderas y estufas de combustibles sólidos
- Fuegos bajos
- Cocinas de leña



## CARACTERÍSTICAS

- Temperatura de trabajo hasta 600°C
- **Soldadura TIG/LÁSER** en continuo en todas las piezas
- **Abrazadera de unión incluida (excepto terminales)**
- Posibilidad de **corte de módulos rectos a medida** en obra (ver instrucciones de corte página 53)
- Chimenea con clasificación de **resistencia al fuego**

## CERTIFICADO CE

0036 CPR 9174 030

0036 CPR 9174 044

## CLASIFICACIONES CE (UNE-EN 1856-1)

T600 - N1 - D - V3 - L50040 - G(70)

T450 - N1 - D - V3 - L50040 - G(60)

T400 - N1 - W - V2 - L50040 - O(30)

## CLASIFICACIONES DE RESISTENCIA AL FUEGO SEGÚN EN 13501-2

EI180 ve (o-->i) T200

EI120 ve (o-->i) T600

EI120 ho (o-->i) T600



## Sistema DW-ECO 1.0 316 SCHWARZ



Módulo recto 1000mm



Módulo recto 500mm



Módulo recto 250mm



Módulo recto regulable  
400-560mm



Módulo recto regulable  
560-920mm

Ø80	B09-DWECO130080	204€	Ø80	B09-DWECO140080	145€	Ø80	B09-DWECO150080	106€	Ø80	B09-DWECO5440080	204€	Ø80	B09-DWECO5450080	307€
Ø100	B09-DWECO130100	211€	Ø100	B09-DWECO140100	156€	Ø100	B09-DWECO150100	110€	Ø100	B09-DWECO5440100	211€	Ø100	B09-DWECO5450100	318€
Ø130	B09-DWECO130130	219€	Ø130	B09-DWECO140130	160€	Ø130	B09-DWECO150130	113€	Ø130	B09-DWECO5440130	219€	Ø130	B09-DWECO5450130	327€
Ø150	B09-DWECO130150	245€	Ø150	B09-DWECO140150	180€	Ø150	B09-DWECO150150	125€	Ø150	B09-DWECO5440150	244€	Ø150	B09-DWECO5450150	364€



Codo 15°



Codo 30°



Codo 45°



Codo 60°



Codo 90°

Ø80	B09-DWECO160080	145€	Ø80	B09-DWECO170080	145€	Ø80	B09-DWECO180080	145€	Ø80	B09-DWECO840080	180€	Ø80	B09-DWECO600080	208€
Ø100	B09-DWECO160100	156€	Ø100	B09-DWECO170100	156€	Ø100	B09-DWECO180100	156€	Ø100	B09-DWECO840100	186€	Ø100	B09-DWECO600100	219€
Ø130	B09-DWECO160130	160€	Ø130	B09-DWECO170130	160€	Ø130	B09-DWECO180130	160€	Ø130	B09-DWECO840130	197€	Ø130	B09-DWECO600130	224€
Ø150	B09-DWECO160150	178€	Ø150	B09-DWECO170150	178€	Ø150	B09-DWECO180150	178€	Ø150	B09-DWECO840150	215€	Ø150	B09-DWECO600150	253€



Te 90°



Te 135°



Te pellets



Colector de hollín



Colector de hollín con  
desagüe

Ø80	B09-DWECO3170080	305€	Ø80	B09-DWECO120080	435€	Ø80	B09-DWECO12970080	235€	Ø80	B09-DWECO5510080	56€	Ø80	B09-DWECO440080	68€
Ø100	B09-DWECO3170100	317€	Ø100	B09-DWECO120100	452€	Ø100	B09-DWECO12970100	242€	Ø100	B09-DWECO5510100	60€	Ø100	B09-DWECO440100	69€
Ø130	B09-DWECO3170130	325€	Ø130	B09-DWECO120130	469€				Ø130	B09-DWECO5510130	69€	Ø130	B09-DWECO440130	83€
Ø150	B09-DWECO3170150	352€	Ø150	B09-DWECO120150	521€				Ø150	B09-DWECO5510150	79€	Ø150	B09-DWECO440150	97€



Módulo de inspección



Módulo de inspección con  
tapa 40 Pa (N1)

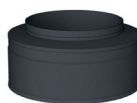

Terminal salida libre

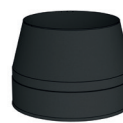

Terminal salida cónica



Terminal anti-lluvia

Ø80	B09-DWECO5430080	178€	Ø80	B09-DWECO680080	284€	Ø80	B09-DWECO320080	97€	Ø80	B09-DWECO32C0080	110€	Ø80	B09-DWECO5260080	130€
Ø100	B09-DWECO5430100	182€	Ø100	B09-DWECO680100	311€	Ø100	B09-DWECO320100	100€	Ø100	B09-DWECO32C0100	113€	Ø100	B09-DWECO5260100	138€
Ø130	B09-DWECO5430130	186€	Ø130	B09-DWECO680130	325€	Ø130	B09-DWECO320130	102€	Ø130	B09-DWECO32C0130	115€	Ø130	B09-DWECO5260130	142€
Ø150	B09-DWECO5430150	208€	Ø150	B09-DWECO680150	340€	Ø150	B09-DWECO320150	115€	Ø150	B09-DWECO32C0150	130€	Ø150	B09-DWECO5260150	160€



Terminal anti-viento



Terminal horizontal con rejilla



Regulador de tiro



Adaptador doble a simple



Adaptador simple a doble

Ø80	B09-DWECO5270080	190€	Ø80	B09-DWECO5320080	123€	Ø80	B09-DWECO5310080	307€	Ø80	B09-DWECO37A0080	66€	Ø80	B09-DWECO370080	66€
Ø100	B09-DWECO5270100	199€	Ø100	B09-DWECO5320100	123€	Ø100	B09-DWECO5310100	318€	Ø100	B09-DWECO37A0100	72€	Ø100	B09-DWECO370100	72€
Ø130	B09-DWECO5270130	204€	Ø130	B09-DWECO5320130	126€	Ø130	B09-DWECO5310130	327€	Ø130	B09-DWECO37A0130	72€	Ø130	B09-DWECO370130	72€
Ø150	B09-DWECO5270150	225€	Ø150	B09-DWECO5320150	142€	Ø150	B09-DWECO5310150	364€	Ø150	B09-DWECO37A0150	83€	Ø150	B09-DWECO370150	83€

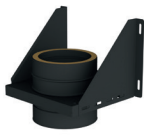

Soporte de carga regulable



Abrazadera de unión 1.0



Abrazadera fijación pared regulable 50-80mm



Alas distanciadoras D



Abrazadera de soporte

Ø80	B09-DWECO3790080	266€	Ø80	AQ1-ZUWA450130	8.49€	Ø80	AQ1-ZUWA5560130	48.66€	Ø80	AQ1-ZUWA1462D	135€	Ø130	AQ1-ZUWA8580180	188€
Ø100	B09-DWECO3790100	275€	Ø100	AQ1-ZUWA450150	10.59€	Ø100	AQ1-ZUWA5560150	51€	Ø100	AQ1-ZUWA1462D	135€	Ø150	AQ1-ZUWA8580200	188€
Ø130	B09-DWECO3790130	280€	Ø130	AQ1-ZUWA450180	12.68€	Ø130	AQ1-ZUWA5560180	51€	Ø130	AQ1-ZUWA1462D	135€			
Ø150	B09-DWECO3790150	314€	Ø150	AQ1-ZUWA450200	14.8€	Ø150	AQ1-ZUWA5560200	60€	Ø150	AQ1-ZUWA1462D	135€			



Abrazadera con doble pértiga telescópica L=2000mm



Abrazadera fijación a techo



Abrazadera vientos



Soporte de techo



Collarín antitormenta

Ø80	AQ1-ZUWA1910130	187€	Ø80	AQ1-ZUWA118B0130	51€	Ø80	AQ1-ZUWA420130	14.8€	Ø80	AQ1-ZUWA9360130	44.4€	Ø80	AQ1-ZUWA3070130	38.06€
Ø100	AQ1-ZUWA1910150	190€	Ø100	AQ1-ZUWA118B0150	56€	Ø100	AQ1-ZUWA420150	19.04€	Ø100	AQ1-ZUWA9360150	54€	Ø100	AQ1-ZUWA3070150	44.4€
Ø130	AQ1-ZUWA1910180	203€	Ø130	AQ1-ZUWA118B0180	64€	Ø130	AQ1-ZUWA420180	27.5€	Ø130	AQ1-ZUWA9360180	66€	Ø130	AQ1-ZUWA3070180	54€
Ø150	AQ1-ZUWA1910200	225€	Ø150	AQ1-ZUWA118B0200	76€	Ø150	AQ1-ZUWA420200	33.85€	Ø150	AQ1-ZUWA9360200	72€	Ø150	AQ1-ZUWA3070200	62€

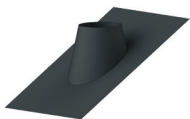

Cubreaguas 25°-45° aluminio

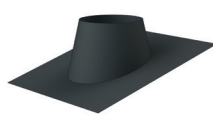

Cubreaguas 5°-25° aluminio

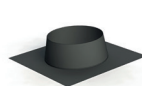

Cubreaguas plano inox

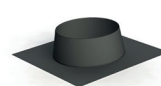

Cubreaguas plomo 0°-5°

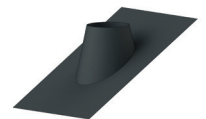

Cubreaguas plomo 25°-45°

Ø80	AQ1-ZUWA939AL0130	285€	Ø80	AQ1-ZUWA938AL0130	268€	Ø80	AQ1-ZUWA11280130	190€	Ø80	AQ1-ZUWA9370130	267€	Ø80	AQ1-ZUWA9390130	466€
Ø100	AQ1-ZUWA939AL0150	303€	Ø100	AQ1-ZUWA938AL0150	280€	Ø100	AQ1-ZUWA11280150	197€	Ø100	AQ1-ZUWA9370150	268€	Ø100	AQ1-ZUWA9390150	472€
Ø130	AQ1-ZUWA939AL0180	325€	Ø130	AQ1-ZUWA938AL0180	305€	Ø130	AQ1-ZUWA11280180	220€	Ø130	AQ1-ZUWA9370180	304€	Ø130	AQ1-ZUWA9390180	492€
Ø150	AQ1-ZUWA939AL0200	349€	Ø150	AQ1-ZUWA938AL0200	328€	Ø150	AQ1-ZUWA11280200	242€	Ø150	AQ1-ZUWA9370200	339€	Ø150	AQ1-ZUWA9390200	502€



## Sistema DW-ECO 1.0 316 SCHWARZ

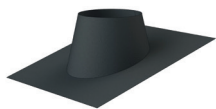

Cubreaguas plomo 5°-25°



Pasamuros

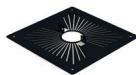

Soporte cubierta ventilado

Ø80	AQ1-ZUWA9380130	267€	Ø80	AQ1-ZUWA9870130	51€	Ø80	AQ1-ZUWA9340130	82€
Ø100	AQ1-ZUWA9380150	268€	Ø100	AQ1-ZUWA9870150	54€	Ø100	AQ1-ZUWA9340150	87€
Ø130	AQ1-ZUWA9380180	304€	Ø130	AQ1-ZUWA9870180	68€	Ø130	AQ1-ZUWA9340180	93€
Ø150	AQ1-ZUWA9380200	339€	Ø150	AQ1-ZUWA9870200	68€	Ø150	AQ1-ZUWA9340200	102€

## ADAPTADOR CALDERA HEMBRA

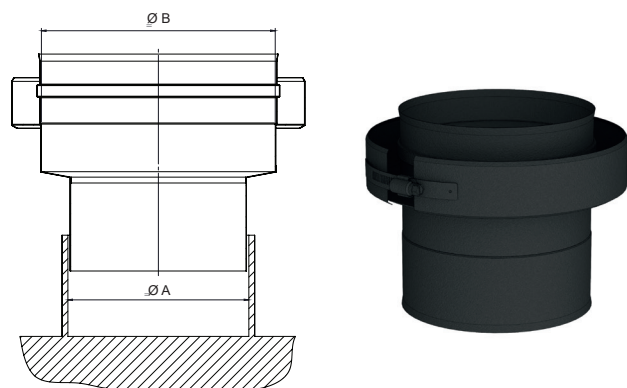

CÓDIGO	Ø A	Ø B	€
B09-DWECO37H00800080	Ø80	Ø80	74€
B09-DWECO37H00800130	Ø80	Ø130	110€
B09-DWECO37H01000100	Ø100	Ø100	78€
B09-DWECO37H01000130	Ø100	Ø130	113€
B09-DWECO37H01000150	Ø100	Ø150	128€
B09-DWECO37H01100080	Ø110	Ø80	115€
B09-DWECO37H01100100	Ø110	Ø100	117€
B09-DWECO37H01100130	Ø110	Ø130	113€
B09-DWECO37H01100150	Ø110	Ø150	128€
B09-DWECO37H01200080	Ø120	Ø80	117€
B09-DWECO37H01200100	Ø120	Ø100	117€
B09-DWECO37H01200130	Ø120	Ø130	113€
B09-DWECO37H01200150	Ø120	Ø150	128€
B09-DWECO37H01250080	Ø125	Ø80	117€
B09-DWECO37H01250100	Ø125	Ø100	117€
B09-DWECO37H01250130	Ø125	Ø130	78€
B09-DWECO37H01250150	Ø125	Ø150	128€
B09-DWECO37H01300080	Ø130	Ø80	117€
B09-DWECO37H01300100	Ø130	Ø100	117€
B09-DWECO37H01300130	Ø130	Ø130	78€
B09-DWECO37H01300150	Ø130	Ø150	129€
B09-DWECO37H01350100	Ø135	Ø100	130€
B09-DWECO37H01350130	Ø135	Ø130	78€
B09-DWECO37H01350150	Ø135	Ø150	129€
B09-DWECO37H01400100	Ø140	Ø100	130€
B09-DWECO37H01400130	Ø140	Ø130	128€
B09-DWECO37H01400150	Ø140	Ø150	87€
B09-DWECO37H01500100	Ø150	Ø100	130€
B09-DWECO37H01500130	Ø150	Ø130	128€
B09-DWECO37H01500150	Ø150	Ø150	87€
B09-DWECO37H01600130	Ø160	Ø130	142€
B09-DWECO37H01600150	Ø160	Ø150	87€
B09-DWECO37H01750130	Ø175	Ø130	142€
B09-DWECO37H01750150	Ø175	Ø150	145€
B09-DWECO37H01800130	Ø180	Ø130	142€
B09-DWECO37H01800150	Ø180	Ø150	145€
B09-DWECO37H02000150	Ø200	Ø150	160€

## AMPLIACIÓN

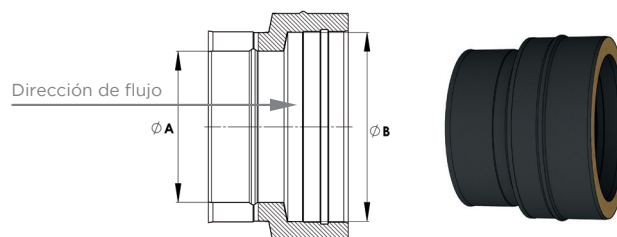

CÓDIGO	Ø A	Ø B	€
B09-DWECO A00800130	Ø80	Ø130	244€
B09-DWECO A00800150	Ø80	Ø150	294€
B09-DWECO A01000130	Ø100	Ø130	220€
B09-DWECO A01000150	Ø100	Ø150	284€
B09-DWECO A01300150	Ø130	Ø150	258€



**Chimenea modular metálica para evacuación de humos y gases de los productos de la combustión de simple pared fabricada en acero DC01 (2mm) con cobertura de pintura resistente a altas temperaturas.**

#### MATERIAL

ACERO DC01 (St12)

#### ACABADO EXTERIOR

Pintado en negro mate (pintura especial altas temperaturas)  
Posibilidad de acabado en gris (consultar precios y plazos)

#### ESPESORES (mm)

2 mm

#### DIÁMETROS DISPONIBLES (mm)

Ø120 a Ø200 (bajo pedido)

#### SISTEMA DE UNIÓN

Conexión macho-hembra **sin abrazadera de unión**



#### APLICACIONES

- Estufas de leña
- Fuegos bajos
- Cassettes de leña



#### CARACTERÍSTICAS

- Instalación interior radiante para aprovechar el calor de los humos (al salir de la sala el conducto de humos debe pasar a doble pared)
- Temperatura de trabajo **hasta 600°C**
- Gran variedad de elementos de **inspección, limpieza y regulación**
- Posibilidad de **corte de módulos rectos a medida en obra**

#### CERTIFICADO CE

0036 CPR 9174 017

#### CLASIFICACIONES CE (UNE-EN 1856-2)

T600 - N1 - D - Vm - L01200 - G(400)



Módulo recto 1000mm



Módulo recto 500mm



Módulo recto 750mm



Módulo recto 330mm



Módulo recto 250mm

Ø120	682-FERRO14010120	66€	Ø120	682-FERRO14030120	34.77€	Ø120	682-FERRO14020120	51€	Ø120	682-FERRO14040120	31.47€	Ø120	682-FERRO14050120	19.88€
Ø130	682-FERRO14010130	67€	Ø130	682-FERRO14030130	39.75€	Ø130	682-FERRO14020130	53€	Ø130	682-FERRO14040130	34.77€	Ø130	682-FERRO14050130	23.21€
Ø150	682-FERRO14010150	79€	Ø150	682-FERRO14030150	46.42€	Ø150	682-FERRO14020150	66€	Ø150	682-FERRO14040150	43.22€	Ø150	682-FERRO14050150	24.85€
Ø160	682-FERRO14010160	90€	Ø160	682-FERRO14030160	51€	Ø160	682-FERRO14020160	71€	Ø160	682-FERRO14040160	46.42€	Ø160	682-FERRO14050160	29.8€
Ø180	682-FERRO14010180	97€	Ø180	682-FERRO14030180	55€	Ø180	682-FERRO14020180	79€	Ø180	682-FERRO14040180	53€	Ø180	682-FERRO14050180	31.47€
Ø200	682-FERRO14010200	115€	Ø200	682-FERRO14030200	66€	Ø200	682-FERRO14020200	91€	Ø200	682-FERRO14040200	63€	Ø200	682-FERRO14050200	34.77€



Módulo recto 150mm con anillo de condensados



Codo 15° sin apertura



Codo 30° sin apertura



Codo 45° sin apertura



Codo 60° sin apertura

Ø120	682-FERRO14650120	39.75€	Ø120	682-FERRO14120120	63€	Ø120	682-FERRO14110120	63€	Ø120	682-FERRO14100120	63€	Ø120	682-FERRO14080120	63€
Ø130	682-FERRO14650130	39.75€	Ø130	682-FERRO14120130	67€	Ø130	682-FERRO14110130	67€	Ø130	682-FERRO14100130	67€	Ø130	682-FERRO14080130	67€
Ø150	682-FERRO14650150	41.63€	Ø150	682-FERRO14120150	71€	Ø150	682-FERRO14110150	71€	Ø150	682-FERRO14100150	71€	Ø150	682-FERRO14080150	71€
Ø160	682-FERRO14650160	43.22€	Ø160	682-FERRO14120160	81€	Ø160	682-FERRO14110160	81€	Ø160	682-FERRO14100160	81€	Ø160	682-FERRO14080160	81€
Ø180	682-FERRO14650180	46.42€	Ø180	682-FERRO14120180	90€	Ø180	682-FERRO14110180	90€	Ø180	682-FERRO14100180	90€	Ø180	682-FERRO14080180	90€
Ø200	682-FERRO14650200	53€	Ø200	682-FERRO14120200	105€	Ø200	682-FERRO14110200	105€	Ø200	682-FERRO14100200	105€	Ø200	682-FERRO14080200	105€



Codo 90° sin apertura



Codo 15° con apertura de limpieza



Codo 30° con apertura de limpieza



Codo 45° con apertura de limpieza



Codo 90° con apertura de limpieza

Ø120	682-FERRO14540120	66€	Ø120	682-FERRO14600120	63€	Ø120	682-FERRO14610120	63€	Ø120	682-FERRO14090120	63€	Ø120	682-FERRO14070120	69€
Ø130	682-FERRO14540130	71€	Ø130	682-FERRO14600130	67€	Ø130	682-FERRO14610130	67€	Ø130	682-FERRO14090130	67€	Ø130	682-FERRO14070130	74€
Ø150	682-FERRO14540150	79€	Ø150	682-FERRO14600150	78€	Ø150	682-FERRO14610150	78€	Ø150	682-FERRO14090150	78€	Ø150	682-FERRO14070150	87€
Ø160	682-FERRO14540160	95€	Ø160	682-FERRO14600160	87€	Ø160	682-FERRO14610160	87€	Ø160	682-FERRO14090160	87€	Ø160	682-FERRO14070160	101€
Ø180	682-FERRO14540180	101€	Ø180	682-FERRO14600180	96€	Ø180	682-FERRO14610180	96€	Ø180	682-FERRO14090180	96€	Ø180	682-FERRO14070180	105€
Ø200	682-FERRO14540200	119€	Ø200	682-FERRO14600200	111€	Ø200	682-FERRO14610200	111€	Ø200	682-FERRO14090200	111€	Ø200	682-FERRO14070200	125€



## Sistema FERRO-LUX



Codo ajustable 0°-90° con apertura de limpieza



Curva 45° con apertura de limpieza



Curva 90° con apertura de limpieza



Módulo recto 1000mm reg. tiro y puerta



Módulo recto 300mm reg. tiro y puerta

Ø120	682-FERRO14310120	65€
Ø130	682-FERRO14310130	69€
Ø150	682-FERRO14310150	79€
Ø160	682-FERRO14310160	90€
Ø180	682-FERRO14310180	97€
Ø200	682-FERRO14310200	112€

Ø150	682-FERRO14450150	182€
------	-------------------	------

Ø150	682-FERRO14460150	196€
------	-------------------	------

Ø120	682-FERRO14500120	102€
Ø130	682-FERRO14500130	103€
Ø150	682-FERRO14500150	105€
Ø160	682-FERRO14500160	119€
Ø180	682-FERRO14500180	136€
Ø200	682-FERRO14500200	157€

Ø120	682-FERRO14640120	79€
Ø130	682-FERRO14640130	79€
Ø150	682-FERRO14640150	85€
Ø160	682-FERRO14640160	90€
Ø180	682-FERRO14640180	90€
Ø200	682-FERRO14640200	105€



Módulo recto 500mm reg. tiro y puerta



Tubo acodado 90° con regulador de tiro y puerta



Tubo acodado reg. tiro y puerta + coll. + pasam.



Tubo curvado reg. tiro y puerta + coll. + pasam.



Módulo recto 300mm reg. tiro

Ø120	682-FERRO14510120	87€
Ø130	682-FERRO14510130	87€
Ø150	682-FERRO14510150	90€
Ø160	682-FERRO14510160	102€
Ø180	682-FERRO14510180	96€
Ø200	682-FERRO14510200	111€

Ø120	682-FERRO14690120	141€
Ø130	682-FERRO14690130	143€
Ø150	682-FERRO14690150	148€
Ø160	682-FERRO14690160	169€
Ø180	682-FERRO14690180	188€
Ø200	682-FERRO14690200	221€

Ø120	682-FERRO14160120	151€
Ø130	682-FERRO14160130	160€
Ø150	682-FERRO14160150	169€
Ø160	682-FERRO14160160	193€
Ø180	682-FERRO14160180	208€
Ø200	682-FERRO14160200	246€

Ø150	682-FERRO14170150	347€
------	-------------------	------

Ø120	682-FERRO14180120	63€
Ø130	682-FERRO14180130	65€
Ø150	682-FERRO14180150	69€
Ø160	682-FERRO14180160	73€
Ø180	682-FERRO14180180	73€
Ø200	682-FERRO14180200	81€



Adaptador a EW-ECO para patinillo

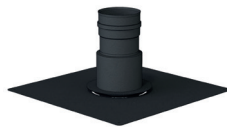

Adaptador a EW-ECO para patinillo con ampliación

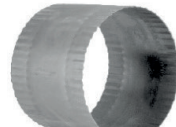

Conector, sin pintar



Atravesador de techo circular

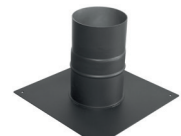

Atravesador de techo cuadrado

Ø130	K02-EWEC20640130	252€
Ø150	K02-EWEC20640150	272€
Ø180	K02-EWEC20640180	295€
Ø200	K02-EWEC20640200	313€

Ø130	K02-EWEC43840130	304€
Ø180	K02-EWEC43840180	352€

Ø120	682-FERRO14430120	19.88€
Ø130	682-FERRO14430130	19.88€
Ø150	682-FERRO14430150	19.88€
Ø160	682-FERRO14430160	21.55€
Ø180	682-FERRO14430180	24.85€
Ø200	682-FERRO14430200	28.2€

Ø120	682-FERRO14620120	105€
Ø130	682-FERRO14620130	109€
Ø150	682-FERRO14620150	112€
Ø160	682-FERRO14620160	119€
Ø180	682-FERRO14620180	123€
Ø200	682-FERRO14620200	141€

Ø120	682-FERRO14630120	105€
Ø130	682-FERRO14630130	109€
Ø150	682-FERRO14630150	112€
Ø160	682-FERRO14630160	119€
Ø180	682-FERRO14630180	123€
Ø200	682-FERRO14630200	141€



Pasamuros 100mm



Rosetón 55mm



Rosetón 85mm

Ø120	682-FERRO14130120	19.88€	Ø120	682-FERRO14220120	9.94€	Ø120	682-FERRO14230120	19.88€
Ø130	682-FERRO14130130	21.55€	Ø130	682-FERRO14220130	9.94€	Ø130	682-FERRO14230130	21.55€
Ø150	682-FERRO14130150	24.85€	Ø150	682-FERRO14220150	13.24€	Ø150	682-FERRO14230150	29.8€
Ø160	682-FERRO14130160	28.2€	Ø160	682-FERRO14220160	14.9€	Ø160	682-FERRO14230160	34.77€
Ø180	682-FERRO14130180	29.8€	Ø180	682-FERRO14220180	14.9€	Ø180	682-FERRO14230180	34.77€
Ø200	682-FERRO14130200	34.77€	Ø200	682-FERRO14220200	19.88€	Ø200	682-FERRO14230200	39.75€

## AMPLIACIÓN



CÓDIGO	Ø A	Ø B	€
682-FERRO-E1120130	Ø120	Ø130	43.22€
682-FERRO-E1120150	Ø120	Ø150	49.62€
682-FERRO-E1120160	Ø120	Ø160	49.62€
682-FERRO-E1120180	Ø120	Ø180	53€
682-FERRO-E1120200	Ø120	Ø200	61€
682-FERRO-E1130150	Ø130	Ø150	49.62€
682-FERRO-E1130160	Ø130	Ø160	49.62€
682-FERRO-E1130180	Ø130	Ø180	55€
682-FERRO-E1130200	Ø130	Ø200	62€
682-FERRO-E1150160	Ø150	Ø160	49.62€
682-FERRO-E1150180	Ø150	Ø180	53€
682-FERRO-E1150200	Ø150	Ø200	62€
682-FERRO-E1160180	Ø160	Ø180	61€
682-FERRO-E1160200	Ø160	Ø200	65€
682-FERRO-E1180200	Ø180	Ø200	62€

## REDUCCIÓN



CÓDIGO	Ø A	Ø B	€
682-FERRO-R1130120	Ø130	Ø120	61€
682-FERRO-R1150120	Ø150	Ø120	62€
682-FERRO-R1150130	Ø150	Ø130	62€
682-FERRO-R1160130	Ø160	Ø130	51€
682-FERRO-R1160150	Ø160	Ø150	57€
682-FERRO-R1180120	Ø180	Ø120	66€
682-FERRO-R1180130	Ø180	Ø130	66€
682-FERRO-R1180150	Ø180	Ø150	65€
682-FERRO-R1180160	Ø180	Ø160	66€
682-FERRO-R1200130	Ø200	Ø130	69€
682-FERRO-R1200150	Ø200	Ø150	69€
682-FERRO-R1200160	Ø200	Ø160	62€
682-FERRO-R1200180	Ø200	Ø180	69€



**Conducto modular metálico de simple pared en acero vitrificado con acabado liso sin necesidad de juntas, dando estética de tubo continuo en las uniones. Especialmente diseñado para su instalación dentro de la sala de la estufa de leña como elemento radiante.**

#### MATERIAL

Acero vitrificado

#### ACABADO EXTERIOR

Vitrificado negro mate premium

#### ESPESORES (mm)

Espesor de acero: 0,80 mm

Espesor total (incluido el vitrificado): 1,10 mm

#### DIÁMETROS DISPONIBLES (mm)

Ø125 a Ø200

#### SISTEMA DE UNIÓN

Conexión macho-hembra sin abrazadera de unión con aspecto continuo.



#### APLICACIONES

- Estufas de leña
- Fuegos bajos
- Cassettes de leña



#### CARACTERÍSTICAS

- Instalación interior radiante para aprovechar el calor de los humos (al salir de la sala el conducto de humos debe pasar a doble pared)
- Temperatura de trabajo hasta 600°C

#### CERTIFICADO CE

0036 CPR 9174 116

#### CLASIFICACIONES CE (UNE-EN 1856-2)

T600 - N1 - D - V2 - L80110 - G800M



Módulo recto 1000mm



Módulo recto 500mm



Módulo recto 330mm



Codo 45°



Codo 90°

Ø125	141-ENAM130125	54€	Ø125	141-ENAM140125	45.58€	Ø125	141-ENAM43470125	35.77€	Ø125	141-ENAM180125	48.72€	Ø125	141-ENAM600125	58€
Ø150	141-ENAM130150	56€	Ø150	141-ENAM140150	47.13€	Ø150	141-ENAM43470150	37.43€	Ø150	141-ENAM180150	56€	Ø150	141-ENAM600150	61€
Ø180	141-ENAM130180	71€	Ø180	141-ENAM140180	54€	Ø180	141-ENAM43470180	40.87€	Ø180	141-ENAM180180	65€	Ø180	141-ENAM600180	78€
Ø200	141-ENAM130200	78€	Ø200	141-ENAM140200	64€	Ø200	141-ENAM43470200	50€	Ø200	141-ENAM180200	67€	Ø200	141-ENAM600200	81€



Te 90°



Colector de hollín



Terminal anti-lluvia



Terminal anti-viento



Módulo recto 330mm con reg de tiro

Ø125	141-ENAM3170125	84€	Ø125	141-ENAM5510125	54€	Ø125	141-ENAM5260125	67€	Ø125	141-ENAM5270125	90€	Ø125	141-ENAM43320125	97€
Ø150	141-ENAM3170150	91€	Ø150	141-ENAM5510150	59€	Ø150	141-ENAM5260150	74€	Ø150	141-ENAM5270150	98€	Ø150	141-ENAM43320150	101€
Ø180	141-ENAM3170180	109€	Ø180	141-ENAM5510180	74€	Ø180	141-ENAM5260180	96€	Ø180	141-ENAM5270180	109€	Ø180	141-ENAM43320180	110€
Ø200	141-ENAM3170200	133€	Ø200	141-ENAM5510200	77€	Ø200	141-ENAM5260200	99€	Ø200	141-ENAM5270200	117€	Ø200	141-ENAM43320200	117€



Manguito anticondensados



Manguito hembra-hembra



Manguito macho-macho



Abrazadera centradora

Ø125	141-ENAM43330125	56€	Ø125	141-ENAM6130125	37.43€	Ø125	141-ENAM9720125	37.43€	Ø125	141-ENAM43340125	27.67€
Ø150	141-ENAM43330150	58€	Ø150	141-ENAM6130150	40.87€	Ø150	141-ENAM9720150	40.87€	Ø150	141-ENAM43340150	29.27€
Ø180	141-ENAM43330180	67€	Ø180	141-ENAM6130180	45.58€	Ø180	141-ENAM9720180	45.58€	Ø180	141-ENAM43340180	30.9€
Ø200	141-ENAM43330200	84€	Ø200	141-ENAM6130200	50€	Ø200	141-ENAM9720200	50€	Ø200	141-ENAM43340200	30.9€



## Chimenea metálica flexible para evacuación de humos y gases de los productos de la combustión de doble capa fabricada en acero inoxidable.

### MATERIAL

Pared Capa interior: AISI 316L  
Pared Capa exterior: AISI 304

### ACABADO EXTERIOR

Mate

### ESPEORES (mm)

0,20 (2 x 0,10)

### DIÁMETROS DISPONIBLES (mm)

Ø80 a Ø200

### SISTEMA DE UNIÓN

Unión de tramos mediante accesorios

\* Posibilidad de comprar por metro lineal. Consultar precio.

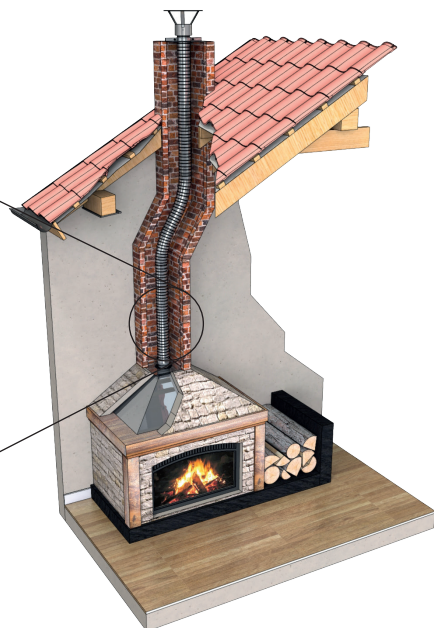
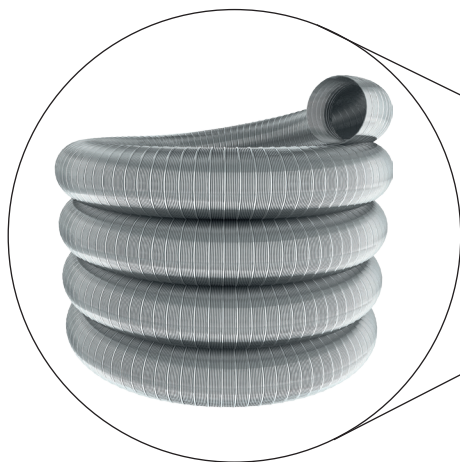

\* Embalaje de cartón para facilitar el porte.



### APLICACIONES

- Entubados por patinillos con dificultad para instalación rígida
- Calderas de gas
- Calderas de condensación
- Combustibles sólidos



### CARACTERÍSTICAS

- Instalación por **patinillo interior**
- Temperatura de trabajo hasta **600°C**
- **Gran gama de accesorios de conexión** entre
- Tramos flexibles y con chimenea rígida
- Posibilidad de **corte a medida**
- Todos los **accesorios** están fabricados en **acero inoxidable AISI 316L**

### CERTIFICADO CE

0036 CPR 9174 150

### CLASIFICACIONES CE (UNE-EN 1856-2)

T450 - N1 - W - V2 - L50010 - G  
T200 - P1 - W - V2 - L50010 - O

**i** Para el diámetro Ø250 mm consultar precio y disponibilidad.



Tubo flexible (rollo 60 m)



Tubo flexible (rollo 50 m)



Tubo flexible (rollo 35 m)



Tubo flexible (rollo 30 m)



Tubo flexible (rollo 20 m)

Ø80	BW1-FLEXT0080-60	2421€	Ø100	BW1-FLEXT0100-50	2453€	Ø150	BW1-FLEXT0150-35	2703€	Ø180	BW1-FLEXT0180-30	2685€	Ø250	BW1-FLEXT0250-20	3346€
			Ø130	BW1-FLEXT0130-50	3333€				Ø200	BW1-FLEXT0200-30	3053€			



Antilluvia básico

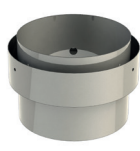

Adaptador caldera

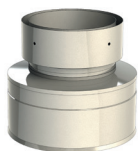

Adaptador DW-ECO 1.0 a flex



Adaptador EW-ECO a flex

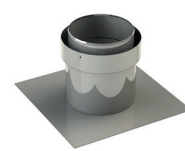

Adaptador FERRO a flex

Ø80	U09-EWECO11720080	48.72€	Ø80	U09-EWECO11770080	42.42€	Ø80	U09-EWECO37C0080	78€	Ø80	U09-EWECO37E0080	42.42€	Ø80	U09-EWECO13220080	84€
Ø100	U09-EWECO11720100	56€	Ø100	U09-EWECO11770100	56€	Ø100	U09-EWECO37C0100	90€	Ø100	U09-EWECO37E0100	58€	Ø100	U09-EWECO13220100	106€
Ø130	U09-EWECO11720130	64€	Ø130	U09-EWECO11770130	62€	Ø130	U09-EWECO37C0130	96€	Ø130	U09-EWECO37E0130	62€	Ø130	U09-EWECO13220130	119€
Ø150	U09-EWECO11720150	67€	Ø150	U09-EWECO11770150	64€	Ø150	U09-EWECO37C0150	104€	Ø150	U09-EWECO37E0150	65€	Ø150	U09-EWECO13220150	132€
Ø180	U09-EWECO11720180	81€	Ø180	U09-EWECO11770180	84€	Ø180	U09-EWECO37C0180	114€	Ø180	U09-EWECO37E0180	88€	Ø180	U09-EWECO13220180	174€
Ø200	U09-EWECO11720200	97€	Ø200	U09-EWECO11770200	109€	Ø200	U09-EWECO37C0200	132€	Ø200	U09-EWECO37E0200	106€	Ø200	U09-EWECO13220200	232€
Ø250	U09-EWECO11720250	121€	Ø250	U09-EWECO11770250	139€				Ø250	U09-EWECO37E0250	133€			

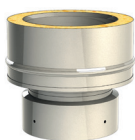

Adaptador flex a DW-ECO 1.0



Adaptador flex a EW-ECO

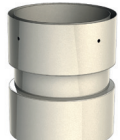

Adaptador flex-flex



Placa de cierre superior



Abrazadera superior

Ø80	U09-EWECO37D0080	78€	Ø80	U09-EWECO37B0080	42.42€	Ø80	U09-EWECO11740080	52€	Ø80	U09-EWECO11730080	24.4€	Ø80	U09-EWECO11880080	24.4€
Ø100	U09-EWECO37D0100	90€	Ø100	U09-EWECO37B0100	58€	Ø100	U09-EWECO11740100	56€	Ø100	U09-EWECO11730100	32.52€	Ø100	U09-EWECO11880100	27.67€
Ø130	U09-EWECO37D0130	96€	Ø130	U09-EWECO37B0130	62€	Ø130	U09-EWECO11740130	59€	Ø130	U09-EWECO11730130	35.77€	Ø130	U09-EWECO11880130	30.9€
Ø150	U09-EWECO37D0150	104€	Ø150	U09-EWECO37B0150	65€	Ø150	U09-EWECO11740150	62€	Ø150	U09-EWECO11730150	35.77€	Ø150	U09-EWECO11880150	30.9€
Ø180	U09-EWECO37D0180	114€	Ø180	U09-EWECO37B0180	88€	Ø180	U09-EWECO11740180	66€	Ø180	U09-EWECO11730180	35.77€	Ø180	U09-EWECO11880180	40.87€
Ø200	U09-EWECO37D0200	132€	Ø200	U09-EWECO37B0200	106€	Ø200	U09-EWECO11740200	71€	Ø200	U09-EWECO11730200	35.77€	Ø200	U09-EWECO11880200	40.87€
			Ø250	U09-EWECO37B0250	133€	Ø250	U09-EWECO11740250	89€				Ø250	U09-EWECO11880250	51€



**Chimenea modular metálica para evacuación de humos y gases de los productos de la combustión y admisión de aire de doble pared concéntrica fabricada en acero inoxidable interior y exterior.**

### MATERIAL

Pared Interior: AISI 316L  
Pared Exterior: AISI 304

### ACABADO EXTERIOR

Pintado negro exterior  
Opción brillante inox sin pintar.

### ESPESORES (mm)

Pared interior: 0,4 mm  
Pared exterior: 0,4 mm

### DIÁMETROS DISPONIBLES (mm)

Ø80/125 - Ø100/150 - Ø130/200

### SISTEMA DE UNIÓN

Conexión macho-hembra con **abrazadera de unión sencilla (incluida)**

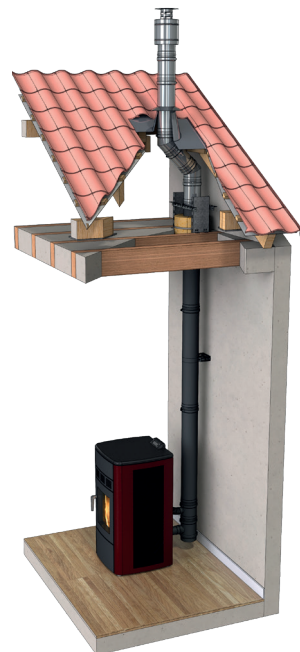

## APLICACIONES

- Estufas de pellets con toma de aire exterior
- Casas pasivas (tanto el circuito de entrada de aire como el de salida de humos están sin comunicación con el interior de la vivienda)



## CARACTERÍSTICAS

- Posibilidad de **conexión de humos por detrás de la estufa, por la parte superior o por debajo de la entrada de aire**
- Temperatura de trabajo hasta **450°C**
- **Soldadura TIG/LASER** en continuo en todas las piezas
- **Abrazadera de unión INCLUIDA**
- **Conexión de entrada de aire** final en simple pared o con tramos flexibles

### CERTIFICADO CE

0036 CPR 9174 065 (combustibles sólidos)

### CLASIFICACIONES CE (UNE-EN 1856-1)

T450 - N1 - D - V2 - L50040 - G(100) (combustibles sólidos)



Módulo recto 1000mm



Módulo recto 500mm



Módulo recto 250mm



Módulo recto regulable  
320-480mm



Codo 45°

Ø80	Z01-TWEC130080	212€	Ø80	Z01-TWEC140080	149€	Ø80	Z01-TWEC150080	110€	Ø80	Z01-TWEC500080	279€	Ø80	Z01-TWEC180080	149€
Ø100	Z01-TWEC130100	218€	Ø100	Z01-TWEC140100	156€	Ø100	Z01-TWEC150100	114€	Ø100	Z01-TWEC500100	297€	Ø100	Z01-TWEC180100	156€
Ø130	Z01-TWEC130130	224€	Ø130	Z01-TWEC140130	165€	Ø130	Z01-TWEC150130	117€	Ø130	Z01-TWEC500130	318€	Ø130	Z01-TWEC180130	165€



Codo 87°



Codo 90°



Te 90°



Te 90° entrada aire



Te 90° entrada aire  
Ø60mm

Ø80	Z01-TWEC640080	216€	Ø80	Z01-TWEC600080	216€	Ø80	Z01-TWEC3170080	311€	Ø80	Z01-TWEC14660080	100€	Ø80	Z01-TWEC20680080	103€
Ø100	Z01-TWEC640100	224€	Ø100	Z01-TWEC600100	224€	Ø100	Z01-TWEC3170100	327€	Ø100	Z01-TWEC14660100	103€	Ø100	Z01-TWEC20680100	107€
Ø130	Z01-TWEC640130	227€	Ø130	Z01-TWEC600130	227€	Ø130	Z01-TWEC3170130	334€	Ø130	Z01-TWEC14660130	112€	Ø130	Z01-TWEC20680130	117€



Te 90° entrada aire  
Ø80mm (H)



Te 90° salida de humos



Te 90° salida de humos  
Ø80mm H



Te compact con inspección



Colector de hollín  
concéntrico con desagüe

Ø80	Z01-TWEC1466F0080	104€	Ø80	Z01-TWEC14590080	179€	Ø80	Z01-TWEC20670080	179€	Ø80	Z01-TWEC20580080	405€	Ø80	Z01-TWEC2050F0080	127€
Ø100	Z01-TWEC1466F0100	107€	Ø100	Z01-TWEC14590100	192€	Ø100	Z01-TWEC20670100	184€	Ø100	Z01-TWEC20580100	438€	Ø100	Z01-TWEC2050F0100	134€
Ø130	Z01-TWEC1466F0130	114€	Ø130	Z01-TWEC14590130	198€	Ø130	Z01-TWEC20670130	194€	Ø130	Z01-TWEC20580130	469€	Ø130	Z01-TWEC2050F0130	145€



Módulo de inspección



Módulo de inspección con  
tapa 40 Pa (N1)



Terminal horizontal  
cortable



Terminal horizontal corto



Terminal vertical

Ø80	Z01-TWEC510080	170€	Ø80	Z01-TWEC680080	274€	Ø80	Z01-TWEC360080	383€	Ø80	Z01-TWEC36C0080	346€	Ø80	Z01-TWEC3580080	438€
Ø100	Z01-TWEC510100	149€	Ø100	Z01-TWEC680100	286€	Ø100	Z01-TWEC360100	415€	Ø100	Z01-TWEC36C0100	373€	Ø100	Z01-TWEC3580100	457€
Ø130	Z01-TWEC510130	177€	Ø130	Z01-TWEC680130	289€	Ø130	Z01-TWEC360130	435€	Ø130	Z01-TWEC36C0130	392€	Ø130	Z01-TWEC3580130	467€



# Sistema TWIN-BIOMASS NEGRO

Coste por de hollín incluido.



Terminal vertical corto



Módulo de soporte recortable



Flexible para conexión de aire 1 m



Flexible para conexión de aire 10 m



Abrazadera de unión 1.0

Ø80	Z01-TWEC358C0080	392€	Ø80	Z01-TWEC21160080	179€	Ø80	646-TWECFLEX1M0080	76€	Ø80	646-TWECFLEX10M0080	686€	Ø80	AQ1-ZUWA450125	8.49€
Ø100	Z01-TWEC358C0100	413€	Ø100	Z01-TWEC21160100	185€							Ø100	AQ1-ZUWA450150	10.59€
Ø130	Z01-TWEC358C0130	417€	Ø130	Z01-TWEC21160130	194€							Ø130	AQ1-ZUWA450200	14.8€



Abrazadera fijación pared regulable 50-80mm



Abrazadera fijación pared sencilla



Abrazadera de araña



Abrazadera con doble pértiga telescópica L=2000mm



Abrazadera vientos

Ø80	AQ1-ZUWA5560125	48.66€	Ø80	AQ1-ZUWA5350125	19.04€	Ø80	665-ZUWA400125	9.75€	Ø80	AQ1-ZUWA1910125	187€	Ø80	AQ1-ZUWA420125	14.8€
Ø100	AQ1-ZUWA5560150	51€	Ø100	AQ1-ZUWA5350150	25.37€	Ø100	665-ZUWA400150	9.75€	Ø100	AQ1-ZUWA1910150	190€	Ø100	AQ1-ZUWA420150	19.04€
Ø130	AQ1-ZUWA5560200	60€	Ø130	AQ1-ZUWA5350200	38.06€	Ø130	665-ZUWA400200	14.65€	Ø130	AQ1-ZUWA1910200	225€	Ø130	AQ1-ZUWA420200	33.85€
						Ø80	AQ1-ZUWA400125	12.68€						
						Ø100	AQ1-ZUWA400150	12.68€						
						Ø130	AQ1-ZUWA400200	19.04€						



Soporte de techo



Collarín antitormenta

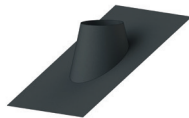

Cubreaguas 25°-45° aluminio

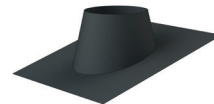

Cubreaguas 5°-25° aluminio

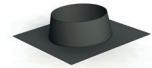

Cubreaguas plano inox

Ø80	AQ1-ZUWA9360125	44.4€	Ø80	AQ1-ZUWA3070125	38.06€	Ø80	AQ1-ZUWA939AL0125	285€	Ø80	AQ1-ZUWA938AL0125	268€	Ø80	AQ1-ZUWA11280125	190€
Ø100	AQ1-ZUWA9360150	54€	Ø100	AQ1-ZUWA3070150	44.4€	Ø100	AQ1-ZUWA939AL0150	303€	Ø100	AQ1-ZUWA938AL0150	280€	Ø100	AQ1-ZUWA11280150	197€
Ø130	AQ1-ZUWA9360200	72€	Ø130	AQ1-ZUWA3070200	62€	Ø130	AQ1-ZUWA939AL0200	349€	Ø130	AQ1-ZUWA938AL0200	328€	Ø130	AQ1-ZUWA11280200	242€

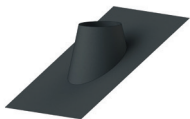

Cubreaguas plomo 25°-45°

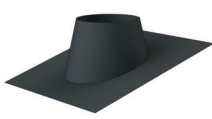

Cubreaguas plomo 5°-25°



Embellec. antifuego cuadrado partido 0°



Embellec. antifuego cuadrado partido 45°



Pasamuros

Ø80	AQ1-ZUWA9390125	466€	Ø80	AQ1-ZUWA9380125	267€	Ø80	AQ1-ZUWA97SS0125	85€	Ø80	AQ1-ZUWA98SS0125	102€	Ø80	AQ1-ZUWA9870125	51€
Ø100	AQ1-ZUWA9390150	472€	Ø100	AQ1-ZUWA9380150	268€	Ø100	AQ1-ZUWA97SS0150	93€	Ø100	AQ1-ZUWA98SS0150	106€	Ø100	AQ1-ZUWA9870150	54€
Ø130	AQ1-ZUWA9390200	502€	Ø130	AQ1-ZUWA9380200	339€	Ø130	AQ1-ZUWA97SS0200	105€	Ø130	AQ1-ZUWA98SS0200	117€	Ø130	AQ1-ZUWA9870200	68€

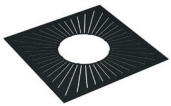

Placa dist. a materiales combustibles ventilada



Placa distanciadora a materiales combustibles

Ø80	AQ1-ZUWA20600125	161€	Ø80	AQ1-ZUWA20590125	139€
Ø100	AQ1-ZUWA20600150	171€	Ø100	AQ1-ZUWA20590150	143€
Ø130	AQ1-ZUWA20600200	180€	Ø130	AQ1-ZUWA20590200	146€



Junta de fibra cerámica

Ø80	665-ZUWA20510080	4.88€
Ø100	665-ZUWA20510100	4.88€
Ø130	665-ZUWA20510130	4.88€





Chimenea modular metálica para evacuación de humos y gases de los productos de la combustión de simple pared fabricada en acero inoxidable.

## MATERIAL

AISI 316L

## ACABADO EXTERIOR

Brillante o pintado en negro mate texturado.

## ESPEORES (mm)

0,4

## DIÁMETROS DISPONIBLES (mm)

Ø80 a Ø100

## SISTEMA DE UNIÓN

Conexión macho-hembra con **abrazadera de unión sencilla**

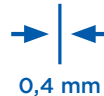

## APLICACIONES

- Estufas de pellets
- Estufas de astillas de madera



## CARACTERÍSTICAS

- Instalación interior radiante para aprovechar el calor de los humos (al salir al exterior de la sala debe pasar a doble pared excepto si va por patinillo interior exclusivo)
- Temperatura de trabajo hasta **200°C**
- **Soldadura TIG/LASER** en continuo en todas las piezas
- Abrazadera de unión **NO INCLUIDA**
- Posibilidad de **corte de módulos rectos a medida** en obra
- **Junta INCLUIDA**

## CERTIFICADO CE

0036 CPR 9174 072

## CLASIFICACIONES CE (UNE-EN 1856-2)

T200 - N1 - D - V2 - L50040 - G(400) M

T200 - P1 - W - V2 - L50040 - O(50) M



# Sistema EW-PELETS NEGRO



5 u/c  
i

Módulo recto 1000mm



5 u/c  
i

Módulo recto 500mm



Módulo recto 250mm



Módulo recto regulable  
400-560mm



Codo 15°

Ø80	40-EWPEI30080	56€	Ø80	40-EWPEI40080	42.42€	Ø80	40-EWPEI50080	35.77€	Ø80	40-EWPE5440080	99€	Ø80	40-EWPE160080	35.77€
Ø100	40-EWPEI30100	65€	Ø100	40-EWPEI40100	44€	Ø100	40-EWPEI50100	37.43€	Ø100	40-EWPE5440100	110€	Ø100	40-EWPE160100	37.43€



Codo 30°



Codo 45°



Codo 90°



Codo 90° H-H



Te 90° con recogida de condensados

Ø80	40-EWPEI70080	35.77€	Ø80	40-EWPEI80080	35.77€	Ø80	40-EWPE600080	47.13€	Ø80	40-EWPE6730080	50€	Ø80	40-EWPE5570080	100€
Ø100	40-EWPEI70100	37.43€	Ø100	40-EWPEI80100	37.43€	Ø100	40-EWPE600100	50€	Ø100	40-EWPE6730100	54€	Ø100	40-EWPE5570100	111€



Te pellets



Te pellets con puerta de inspección



Terminal anti-lluvia



Terminal antilluvia con rejilla



Terminal horizontal

Ø80	40-EWPEI2970080	91€	Ø80	40-EWPEI4190080	106€	Ø80	40-EWPE5260080	87€	Ø80	40-EWPE14040080	109€	Ø80	40-EWPE14050080	67€
Ø100	40-EWPEI2970100	100€	Ø100	40-EWPEI4190100	119€	Ø100	40-EWPE5260100	96€	Ø100	40-EWPE14040100	111€	Ø100	40-EWPE14050100	83€



Terminal horizontal con rejilla



Adapt. de caldera con doble hembra y pto. de insp.



Adaptador a EW-ECO para patinillo



Adaptador de Caldera con doble hembra



Adaptador design

Ø80	40-EWPE5320080	74€	Ø80	40-EWPE6740080	67€	Ø80	L03-EWEC20640080	215€	Ø80	40-EWPE6750080	35.77€	Ø80	B09-DWECO21150080	235€
Ø100	40-EWPE5320100	90€	Ø100	40-EWPE6740100	71€	Ø100	L03-EWEC20640100	235€	Ø100	40-EWPE6750100	40.87€	Ø100	B09-DWECO21150100	247€



# Sistema EW-PELLETS

Precio unidad y precio por pieza.  
Director de hollin incluido.



Abrazadera de unión 1.0



Abrazadera fijación pared regulable 50-80mm



Abrazadera fijación pared sencilla



Collarín antitormenta



Embellecedor design

Ø80	AQ1-ZUWA450080	8.49€	Ø80	AQ1-ZUWA5560080	40.18€	Ø80	AQ1-ZUWA5350080	14.8€	Ø80	AQ1-ZUWA3070080	33.85€	Ø80	AQ1-ZUWA20660080	49.15€
Ø100	AQ1-ZUWA450100	8.49€	Ø100	AQ1-ZUWA5560100	44.4€	Ø100	AQ1-ZUWA5350100	19.04€	Ø100	AQ1-ZUWA3070100	35.97€	Ø100	AQ1-ZUWA20660100	58€

## SISTEMA DW - ECO 1.0 316 PELLETS



Te aislada picaje concent. y toma de aire Ø80/125

Ø80	909-DWECO20610080	235€
Ø100	909-DWECO20610100	296€
Ø130	909-DWECO20610130	341€



Conexión concent. Estufa +toma de aire Ø60

Ø80	Z01-TWEC20620080	278€
-----	------------------	------



Flexible para conexión de aire 1 m

Ø80	646-TWECFLEX1M0080	76€
-----	--------------------	-----



Flexible para conexión de aire 10 m

Ø80	646-TWECFLEX10M0080	686€
-----	---------------------	------

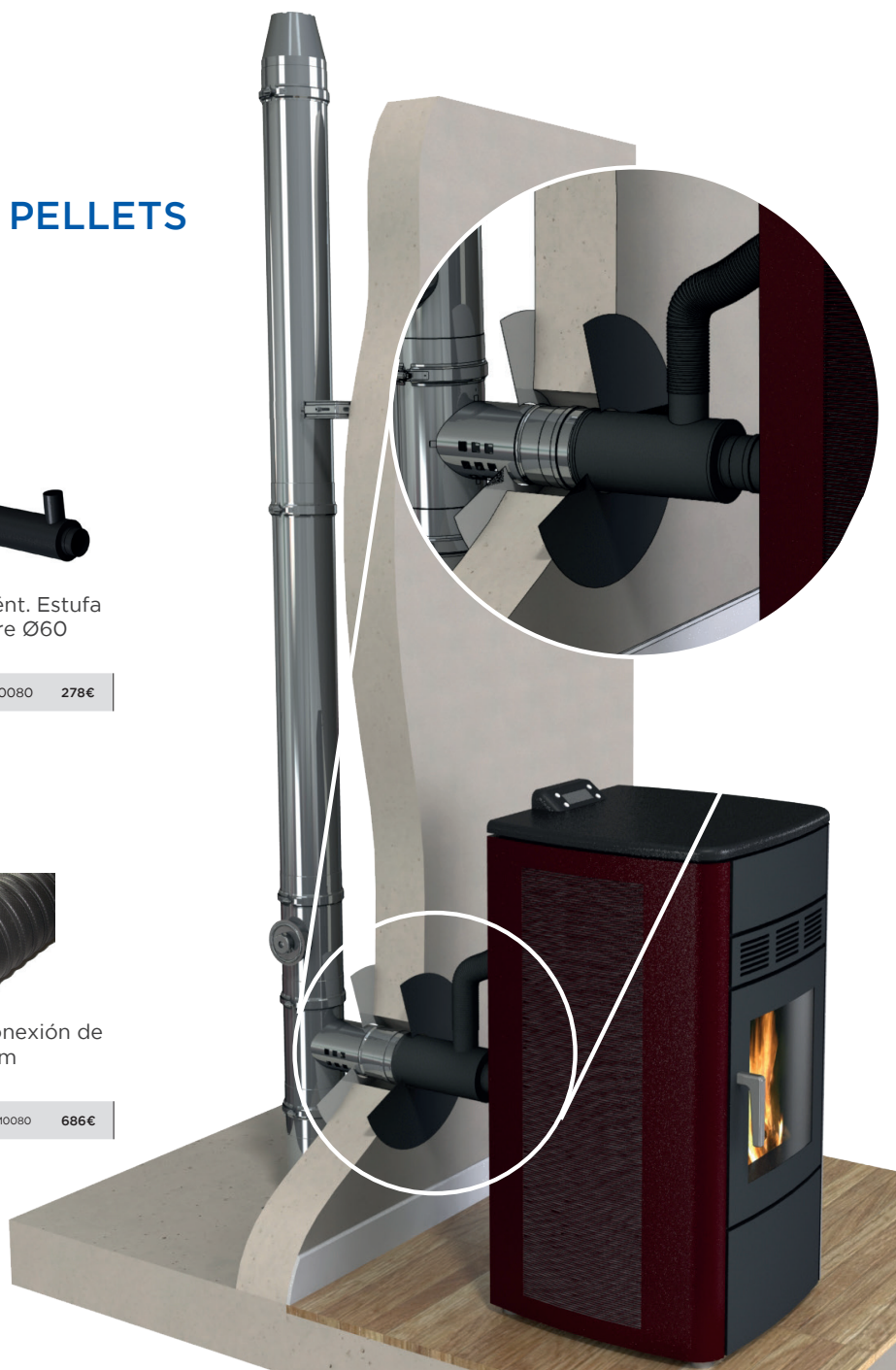



# Sistema EW-PELETS INOX



5 u/c  
i

Módulo recto 1000mm



5 u/c  
i

Módulo recto 500mm



Módulo recto 250mm



Módulo recto regulable  
400-560mm



Codo 15°

Ø80	140-EWPE130080	56€	Ø80	140-EWPE140080	42.42€	Ø80	140-EWPE150080	35.77€	Ø80	140-EWPE5440080	99€	Ø80	140-EWPE160080	35.77€
Ø100	140-EWPE130100	65€	Ø100	140-EWPE140100	44€	Ø100	140-EWPE150100	37.43€	Ø100	140-EWPE5440100	110€	Ø100	140-EWPE160100	37.43€



Codo 30°



Codo 45°



Codo 90°



Codo 90° H-H



Te 90° con recogida de  
condensados

Ø80	140-EWPE170080	35.77€	Ø80	140-EWPE180080	35.77€	Ø80	140-EWPE600080	47.13€	Ø80	140-EWPE6730080	50€	Ø80	140-EWPE5570080	100€
Ø100	140-EWPE170100	37.43€	Ø100	140-EWPE180100	37.43€	Ø100	140-EWPE600100	50€	Ø100	140-EWPE6730100	54€	Ø100	140-EWPE5570100	111€



Te pellets



Te pellets con puerta de  
inspección



Terminal anti-lluvia

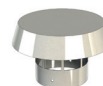

Terminal antilluvia con  
rejilla

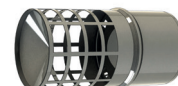

Terminal horizontal

Ø80	140-EWPE12970080	91€	Ø80	140-EWPE14190080	106€	Ø80	140-EWPE5260080	87€	Ø80	140-EWPE14040080	109€	Ø80	140-EWPE14050080	67€
Ø100	140-EWPE12970100	100€	Ø100	140-EWPE14190100	119€	Ø100	140-EWPE5260100	96€	Ø100	140-EWPE14040100	111€	Ø100	140-EWPE14050100	83€

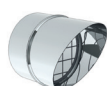

Terminal horizontal con  
rejilla



Adapt. de caldera con  
doble hembra y pto. de  
insp.



Adaptador de Caldera con  
doble hembra



Adaptador design

Ø80	140-EWPE5320080	74€	Ø80	140-EWPE6740080	67€	Ø80	140-EWPE6750080	35.77€	Ø80	909-DWECO21150080	180€
Ø100	140-EWPE5320100	90€	Ø100	140-EWPE6740100	71€	Ø100	140-EWPE6750100	40.87€	Ø100	909-DWECO21150100	190€

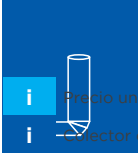

# Sistema EW-PELETS

Precio unidad  
Precio de hollín incluido.



Abrazadera de unión 1.0



Abrazadera fijación pared sencilla



Collarín antitormenta

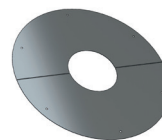

Embellecedor design

Ø80	665-ZUWA450080	6.52€	Ø80	665-ZUWA5350080	11.38€	Ø80	665-ZUWA3070080	26.04€	Ø80	665-ZUWA20660080	37.81€
Ø100	665-ZUWA450100	6.52€	Ø100	665-ZUWA5350100	14.65€	Ø100	665-ZUWA3070100	27.67€	Ø100	665-ZUWA20660100	44€

**Conducto modular metálico de simple pared en acero vitrificado con unión machihembrada sin necesidad de abrazaderas de unión con junta de estanqueidad en el interior de la hembra. Especialmente diseñado para su instalación dentro de la sala de la estufa de pellets como elemento radiante.**

### MATERIAL

Acero vitrificado

### ACABADO EXTERIOR

Vitrificado negro mate premium

### ESPESORES (mm)

Espesor de acero: 0,80 mm

Espesor total (incluido el vitrificado): 1,10 mm

### DIÁMETROS DISPONIBLES (mm)

Ø80

### SISTEMA DE UNIÓN

Conexión macho-hembra sin abrazadera



### APLICACIONES

- Estufas de leña
- Estufas de astillas



### CARACTERÍSTICAS

- Instalación interior radiante para aprovechar el calor de los humos (al salir de la sala el conducto de humos debe pasar a doble pared)
- Temperatura de trabajo hasta 600°C
- **Junta INCLUIDA**

### CERTIFICADO CE

0036 CPR 9174 116

### CLASIFICACIONES CE (UNE-EN 1856-2)

T200 - P1 - W - V2 - L80110 - O60

T600 - N1 - D - V2 - L80110 - G375 NM



## Sistema VITRO-PELLETS



Módulo recto 1000mm



Módulo recto 500mm



Módulo recto 250mm



Módulo recto regulable  
400-640mm



Módulo recto regulable  
640-940mm

Ø80	143-VIPE130080	52€	Ø80	143-VIPE140080	39.04€	Ø80	143-VIPE150080	32.52€	Ø80	143-VIPE5440080	95€	Ø80	143-VIPE5450080	111€
-----	----------------	-----	-----	----------------	--------	-----	----------------	--------	-----	-----------------	-----	-----	-----------------	------



Codo 45°



Codo 90°



Tapa inferior



Te 90° con tapa



Terminal anti-lluvia

Ø80	143-VIPE180080	42.42€	Ø80	143-VIPE600080	54€	Ø80	143-VIPE440080	52€	Ø80	143-VIPE317T0080	130€	Ø80	143-VIPE5260080	62€
-----	----------------	--------	-----	----------------	-----	-----	----------------	-----	-----	------------------	------	-----	-----------------	-----



Terminal anti-viento



Terminal horizontal



Terminal horizontal  
antilluvia



Manguito hembra-hembra



Manguito macho-macho

Ø80	143-VIPE5270080	74€	Ø80	40-EWPE14050080	67€	Ø80	40-EWPE20760080	78€	Ø80	143-VIPE6130080	47.13€	Ø80	143-VIPE9720080	37.43€
-----	-----------------	-----	-----	-----------------	-----	-----	-----------------	-----	-----	-----------------	--------	-----	-----------------	--------



Abrazadera fijación pared  
sencilla



Abrazadera centradora



Collarín antitormenta



Plafón



Junta

Ø80	142-VIPL5350080	26.04€	Ø80	142-VIPL43340080	27.67€	Ø80	142-VIPL3070080	17.9€	Ø80	142-VIPL44150080	34.15€	Ø80	143-VIPE260080	3.27€
-----	-----------------	--------	-----	------------------	--------	-----	-----------------	-------	-----	------------------	--------	-----	----------------	-------

# ACCESORIOS COMUNES



Embellec. antifuego circular  
0°

Ø80	665-ZUWA97R0080	52€
Ø100	665-ZUWA97R0100	56€
Ø130	665-ZUWA97R0130	61€
Ø150	665-ZUWA97R0150	61€
Ø180	665-ZUWA97R0180	64€
Ø200	665-ZUWA97R0200	67€
Ø250	665-ZUWA97R0250	78€



Embellec. antifuego circular  
30°



Embellec. antifuego circular  
45°



Embellec. antifuego circular  
partido 0°



Embellec. antifuego circular  
partido 30°



Embellec. antifuego circular  
partido 45°

Ø80	665-ZUWA99R0080	52€	Ø80	665-ZUWA98R0080	61€	Ø80	665-ZUWA97RS0080	58€	Ø80	665-ZUWA99RS0080	58€	Ø80	665-ZUWA98RS0080	65€
Ø100	665-ZUWA99R0100	52€	Ø100	665-ZUWA98R0100	61€	Ø100	665-ZUWA97RS0100	58€	Ø100	665-ZUWA99RS0100	58€	Ø100	665-ZUWA98RS0100	65€
Ø130	665-ZUWA99R0130	52€	Ø130	665-ZUWA98R0130	61€	Ø130	665-ZUWA97RS0130	58€	Ø130	665-ZUWA99RS0130	58€	Ø130	665-ZUWA98RS0130	65€
Ø150	665-ZUWA99R0150	61€	Ø150	665-ZUWA98R0150	66€	Ø150	665-ZUWA97RS0150	64€	Ø150	665-ZUWA99RS0150	64€	Ø150	665-ZUWA98RS0150	76€
Ø180	665-ZUWA99R0180	64€	Ø180	665-ZUWA98R0180	74€	Ø180	665-ZUWA97RS0180	67€	Ø180	665-ZUWA99RS0180	67€	Ø180	665-ZUWA98RS0180	78€
Ø200	665-ZUWA99R0200	67€	Ø200	665-ZUWA98R0200	78€	Ø200	665-ZUWA97RS0200	76€	Ø200	665-ZUWA99RS0200	76€	Ø200	665-ZUWA98RS0200	83€
Ø250	665-ZUWA99R0250	78€	Ø250	665-ZUWA98R0250	90€	Ø250	665-ZUWA97RS0250	84€	Ø250	665-ZUWA99RS0250	84€	Ø250	665-ZUWA98RS0250	97€



Embellec. antifuego circular  
partido ventilado 0°



Embellec. antifuego circular  
partido ventilado 30°



Embellec. antifuego circular  
partido ventilado 45°



Embellec. antifuego circular  
ventilado 0°



Embellec. antifuego circular  
ventilado 30°

Ø80	665-ZUWA97RSV0080	65€	Ø80	665-ZUWA99RSV0080	65€	Ø80	665-ZUWA98RSV0080	74€	Ø80	665-ZUWA97RV0080	61€	Ø80	665-ZUWA99RV0080	61€
Ø100	665-ZUWA97RSV0100	65€	Ø100	665-ZUWA99RSV0100	65€	Ø100	665-ZUWA98RSV0100	74€	Ø100	665-ZUWA97RV0100	61€	Ø100	665-ZUWA99RV0100	61€
Ø130	665-ZUWA97RSV0130	65€	Ø130	665-ZUWA99RSV0130	65€	Ø130	665-ZUWA98RSV0130	74€	Ø130	665-ZUWA97RV0130	61€	Ø130	665-ZUWA99RV0130	61€
Ø150	665-ZUWA97RSV0150	71€	Ø150	665-ZUWA99RSV0150	71€	Ø150	665-ZUWA98RSV0150	83€	Ø150	665-ZUWA97RV0150	66€	Ø150	665-ZUWA99RV0150	66€
Ø180	665-ZUWA97RSV0180	78€	Ø180	665-ZUWA99RSV0180	78€	Ø180	665-ZUWA98RSV0180	87€	Ø180	665-ZUWA97RV0180	71€	Ø180	665-ZUWA99RV0180	71€
Ø200	665-ZUWA97RSV0200	83€	Ø200	665-ZUWA99RSV0200	83€	Ø200	665-ZUWA98RSV0200	95€	Ø200	665-ZUWA97RV0200	78€	Ø200	665-ZUWA99RV0200	78€
Ø250	665-ZUWA97RSV0250	96€	Ø250	665-ZUWA99RSV0250	96€	Ø250	665-ZUWA98RSV0250	109€	Ø250	665-ZUWA97RV0250	87€	Ø250	665-ZUWA99RV0250	87€

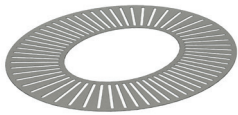

Embellec. antifuego circular ventilado 45°

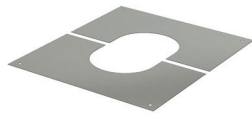

Embellec. antifuego cuadrado partido 0°

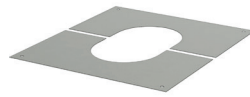

Embellec. antifuego cuadrado partido 30°

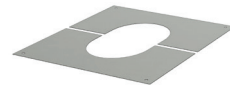

Embellec. antifuego cuadrado partido 45°

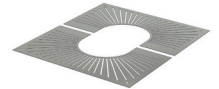

Embellec. antifuego cuadrado partido ventilado 0°

Ø80	665-ZUWA98RV0080	66€	Ø80	665-ZUWA97SS0080	66€	Ø80	665-ZUWA99SS0080	66€	Ø80	665-ZUWA98SS0080	78€	Ø80	665-ZUWA97SSV0080	77€
Ø100	665-ZUWA98RV0100	66€	Ø100	665-ZUWA97SS0100	66€	Ø100	665-ZUWA99SS0100	66€	Ø100	665-ZUWA98SS0100	78€	Ø100	665-ZUWA97SSV0100	77€
Ø130	665-ZUWA98RV0130	66€	Ø130	665-ZUWA97SS0130	66€	Ø130	665-ZUWA99SS0130	66€	Ø130	665-ZUWA98SS0130	78€	Ø130	665-ZUWA97SSV0130	77€
Ø150	665-ZUWA98RV0150	77€	Ø150	665-ZUWA97SS0150	71€	Ø150	665-ZUWA99SS0150	71€	Ø150	665-ZUWA98SS0150	81€	Ø150	665-ZUWA97SSV0150	80€
Ø180	665-ZUWA98RV0180	81€	Ø180	665-ZUWA97SS0180	76€	Ø180	665-ZUWA99SS0180	76€	Ø180	665-ZUWA98SS0180	84€	Ø180	665-ZUWA97SSV0180	83€
Ø200	665-ZUWA98RV0200	87€	Ø200	665-ZUWA97SS0200	80€	Ø200	665-ZUWA99SS0200	80€	Ø200	665-ZUWA98SS0200	91€	Ø200	665-ZUWA97SSV0200	88€
Ø250	665-ZUWA98RV0250	100€	Ø250	665-ZUWA97SS0250	95€	Ø250	665-ZUWA99SS0250	95€	Ø250	665-ZUWA98SS0250	106€	Ø250	665-ZUWA97SSV0250	104€

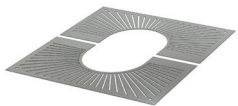

Embellec. antifuego cuadrado partido ventilado 30°

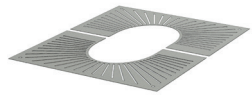

Embellec. antifuego cuadrado partido ventilado 45°

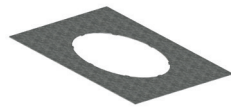

Placa antifuego

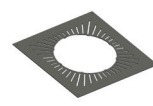

Placa antifuego ventilada galva

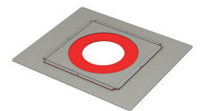

Placa distanciadora con goma 0°

Ø80	665-ZUWA99SSV0080	77€	Ø80	665-ZUWA98SSV0080	87€	Ø130	665-ZUWA720130	48.72€	Ø130	665-ZUWA7900130	64€	Ø130	665-ZUWA17020130	64€
Ø100	665-ZUWA99SSV0100	77€	Ø100	665-ZUWA98SSV0100	87€	Ø150	665-ZUWA720150	52€	Ø150	665-ZUWA7900150	65€	Ø150	665-ZUWA17020150	66€
Ø130	665-ZUWA99SSV0130	77€	Ø130	665-ZUWA98SSV0130	87€	Ø180	665-ZUWA720180	54€	Ø180	665-ZUWA7900180	66€	Ø180	665-ZUWA17020180	67€
Ø150	665-ZUWA99SSV0150	80€	Ø150	665-ZUWA98SSV0150	91€	Ø200	665-ZUWA720200	61€	Ø200	665-ZUWA7900200	76€	Ø200	665-ZUWA17020200	74€
Ø180	665-ZUWA99SSV0180	83€	Ø180	665-ZUWA98SSV0180	96€	Ø250	665-ZUWA720250	80€	Ø250	665-ZUWA7900250	101€	Ø250	665-ZUWA17020250	90€
Ø200	665-ZUWA99SSV0200	88€	Ø200	665-ZUWA98SSV0200	101€									
Ø250	665-ZUWA99SSV0250	104€	Ø250	665-ZUWA98SSV0250	117€									

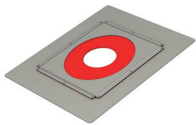

Placa distanciadora con goma 30°

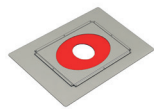

Placa distanciadora con goma 45°

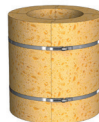

Coquilla antifuego 0°



Coquilla antifuego 30°



Coquilla antifuego 45°

Ø130	665-ZUWA17030130	71€	Ø130	665-ZUWA17040130	81€	Ø130	665-ZUWA1702C0130	161€	Ø130	665-ZUWA1703C0130	161€	Ø130	665-ZUWA1704C0130	261€
Ø150	665-ZUWA17030150	76€	Ø150	665-ZUWA17040150	84€	Ø150	665-ZUWA1702C0150	170€	Ø150	665-ZUWA1703C0150	170€	Ø150	665-ZUWA1704C0150	271€
Ø180	665-ZUWA17030180	77€	Ø180	665-ZUWA17040180	87€	Ø180	665-ZUWA1702C0180	185€	Ø180	665-ZUWA1703C0180	185€	Ø180	665-ZUWA1704C0180	289€
Ø200	665-ZUWA17030200	80€	Ø200	665-ZUWA17040200	91€	Ø200	665-ZUWA1702C0200	203€	Ø200	665-ZUWA1703C0200	203€	Ø200	665-ZUWA1704C0200	321€
Ø250	665-ZUWA17030250	99€	Ø250	665-ZUWA17040250	111€	Ø250	665-ZUWA1702C0250	287€	Ø250	665-ZUWA1703C0250	287€	Ø250	665-ZUWA1704C0250	425€



Mediante este sistema se asegura un acabado perfecto y elegante entre el conducto de unión de la estufa y el conducto de doble pared del exterior de la vivienda. La simplicidad de su diseño ofrece un montaje rápido y cómodo. El embellecedor circular asegura el acabado perfecto.

## MEDIDAS (mm)

500 mm de longitud. El módulo es recortable, permitiendo un ajuste perfecto a cada instalación.

## ACABADO EXTERIOR

Negro mate.

## DIÁMETROS DISPONIBLES (mm)

Este módulo está disponible para los siguientes diámetros:  
80 - 100 - 130 - 150 - 180 - 200.

## SISTEMA DE UNIÓN

Está especialmente fabricado con un machihembrado de 120 mm de longitud que facilita el montaje y desmontaje del conducto de unión, sin necesidad de desmontar toda la instalación.

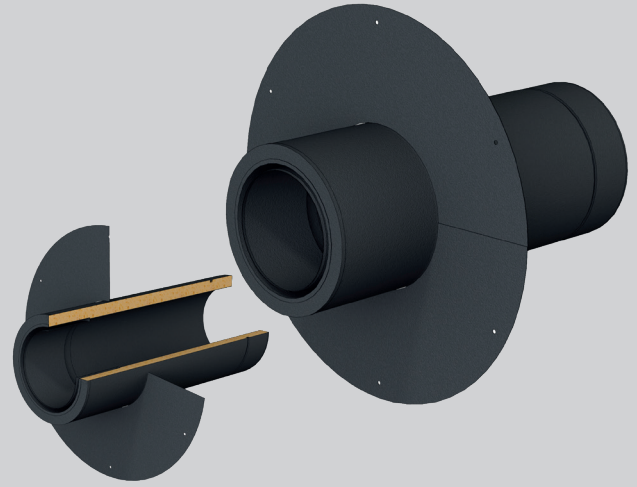

## VENTAJAS

- **Fácil instalación**
- **Acabado estético**
- **Aumenta la eficiencia energética de la vivienda, reduciendo las pérdidas de calor.**
- **Facilidad para desmontar el conducto de simple pared para limpieza de la instalación.**



## INSTALACIÓN

- Fijar el adaptador a nivel del forjado, verificando la distancia a materiales combustibles.
- Introducir el módulo de simple pared en la hendidura del adaptador.
- Deslizar el módulo hasta que conecte en el módulo anterior.
- Colocar el rosetón sellando la instalación.

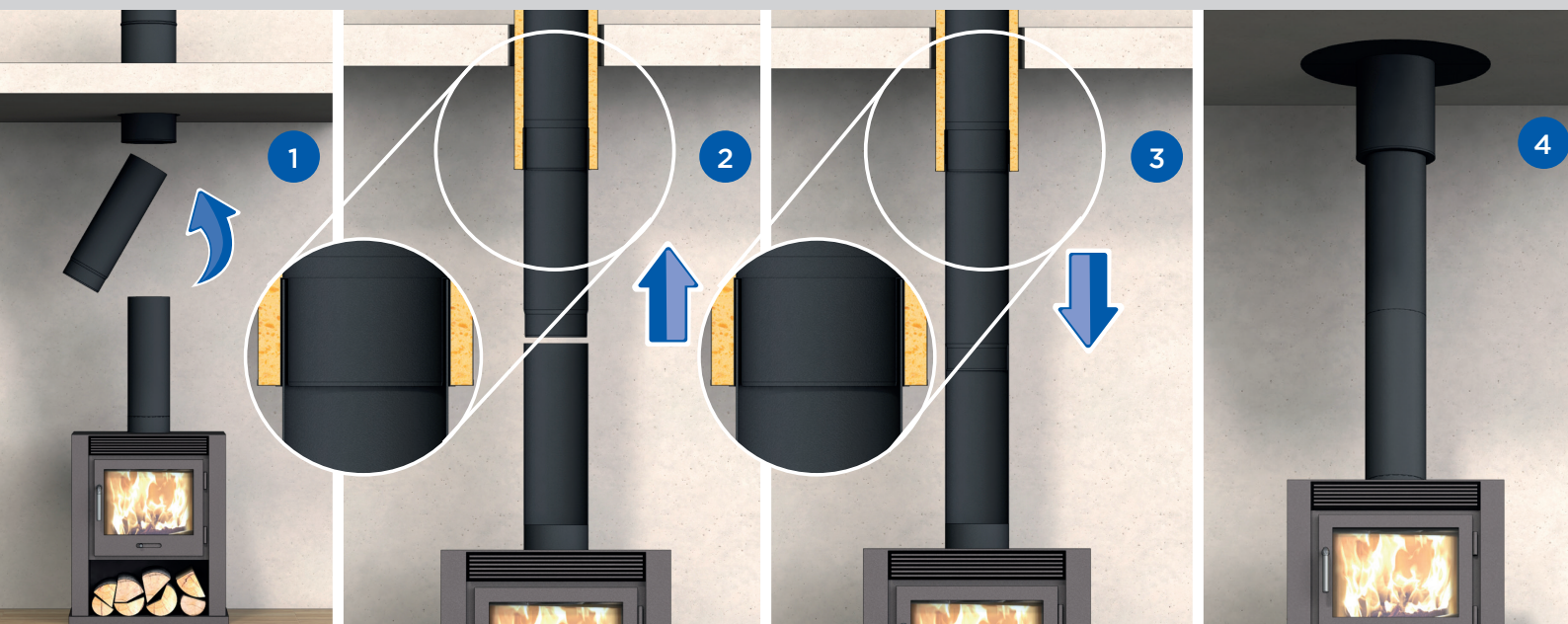

## Embellecedor para Entubados (rígidos o flexibles)

PARA ESTUFAS DE LEÑA & PELLETS



Este sistema asegura un acabado elegante a nivel del techo, entre el conducto de conexión de la estufa y el entubado del interior del patinillo. El embellecedor incluye una protección anti hollín así como aperturas de ventilación para el patinillo.

### MEDIDAS (mm)

400 x 400 mm

### ACABADO EXTERIOR

Negro mate.

### DIÁMETROS DISPONIBLES (mm)

Este embellecedor está disponible para los diámetros:  
80 - 100 para entubados rígidos (EW-ECO).

### SISTEMA DE UNIÓN

Está especialmente fabricado con un machihembrado de 120 mm de longitud que facilita el montaje y desmontaje del conducto de unión, sin necesidad de desmontar toda la instalación. La simplicidad de su diseño ofrece un montaje rápido y cómodo.



### INSTALACIÓN

- Montar el entubado en el interior del patinillo.
- Comprobar las distancias de seguridad a materiales combustibles.
- Fijar el conducto del entubado al embellecedor.
- Fijar el embellecedor al techo cerrando el patinillo.
- Instalar el conducto de conexión de la estufa dejando un margen suficiente en la conexión para poder desmontar el conducto de unión en futuras operaciones de mantenimiento.
- Combustibles sólidos

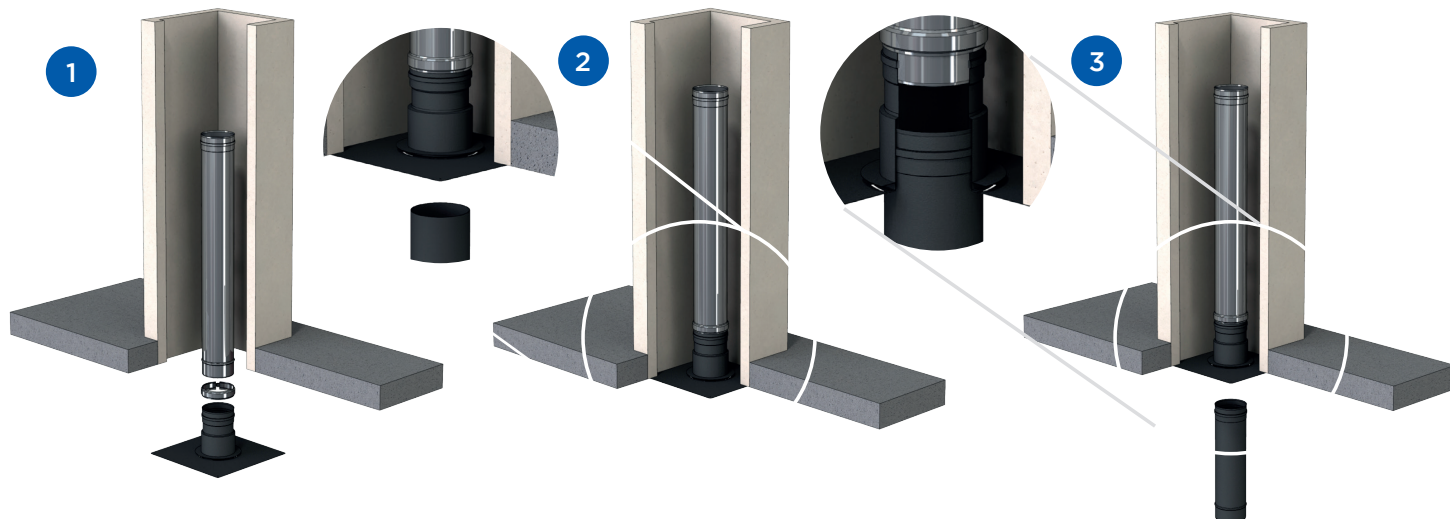



# Índice

<b>GRUPOS ELECTRÓGENOS</b>	<b>180</b>
DW-KL 32 304	182
DW-KL 50 304	189
Accesorios DW-KL	196
Cómo cortar un módulo cortable de DW-KL	197

# Extracción industrial

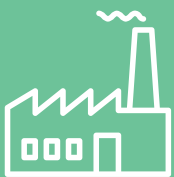

# 179

La extracción de productos de la combustión de motores, ya sean de grupos electrógenos o de cogeneración, tienen dos requisitos principales para las chimeneas: altas temperaturas (por encima de 500°C) y alta presión (hasta 5.000 Pa), y ambos son simultáneos. Es por esto que la estanqueidad no se puede conseguir con juntas ni siliconas, ya que no soportan las altas temperaturas.

La chimenea DWKL es una chimenea con un sistema de unión cónica entre tubos que nos asegura la estanqueidad requerida (ha sido testada con éxito hasta 15.000 Pa de sobrepresión) con gran rapidez de montaje y es el propio sistema el que garantiza la estanqueidad, y no la aplicación de sellantes por parte del instalador utilizada en otros sistemas.



## APLICACIONES

- Grupos electrógenos
- Cogeneración
- Microcogeneración
- Extracción de humos y gases
- Movimiento de partículas ligeras
- Grupos de bombeo
- Calderas sobrepresionadas
- Extracciones químicas
- Hornos de secado
- Incineradoras

	Gas natural	Gasoil	Comb. Sólidos	Condensación	Condiciones húmedas	Temperatura (°C)	Material interior	Material exterior	Espesor mat. Interior (mm)	N=tiro natural P=sobrepresión H=altas presiones	Resist. fuego de hollín
DW-KL 32	●	●	● (opción 316)	-	-	600	AISI 304	AISI 304	0.4 - 0.5 - 0.6 según Ø	N	●
	●	●	-	-	●	600	AISI 304	AISI 304	0.4 - 0.5 - 0.6 según Ø	H	-
	●	●	-	(opción 316)	●	200	AISI 304	AISI 304	0.4 - 0.5 - 0.6 según Ø	H	-
	●	●	-	(opción 316)	●	200	AISI 304	AISI 304	0.4 - 0.5 - 0.6 según Ø	P	-
DW-KL 50	●	●	● (opción 316)	-	-	600	AISI 304	AISI 304	0.4 - 0.5 - 0.6 según Ø	N	●
	●	●	-	-	●	600	AISI 304	AISI 304	0.4 - 0.5 - 0.6 según Ø	H	-
	●	●	-	(opción 316)	●	200	AISI 304	AISI 304	0.4 - 0.5 - 0.6 según Ø	H	-
	●	●	-	(opción 316)	●	200	AISI 304	AISI 304	0.4 - 0.5 - 0.6 según Ø	P	-

### Pesos alturas entre soportes

Pesos aproximados por metro lineal de chimenea en cada modelo y diámetro, así como las alturas máximas entre soportes de carga en función del diámetro para instalación vertical. En la base de la vertical es necesaria la colocación de un soporte de carga (recomendablemente por encima de la te de conexión).

Asimismo, en instalación horizontal se recomienda que la distancia entre abrazaderas de fijación sea de 2 m. En instalación vertical la distancia entre abrazaderas de fijación pared debe ser de 4 m como máximo.



### PESOS (kg)

	DW-KL 32 mm	DW-KL 50 mm
Ø 80	3,9	-
Ø 100	4,5	-
Ø 150	6,3	8,3
Ø 180	7,3	9,5
Ø 200	8,0	10,3
Ø 250	9,7	12,4
Ø 300	11,4	14,5
Ø 350	15,2	18,7
Ø 400	17,1	21,0
Ø 450	19,1	23,3
Ø 500	21,1	25,7
Ø 550	23,1	28,0
Ø 600	28,4	33,8
Ø 650	30,7	36,4
Ø 700	32,9	39,0
Ø 750	35,2	41,6
Ø 800	37,4	44,2



1. Terminal c6nico alta temperatura (**DWKL32HT**)
2. Abrazadera fijaci6n pared (**DWXX556**)
3. M6dulo recto 1.000 mm (**DWKL13**)
4. Soporte de carga regulable (**DWKL379**)
5. Placa tope horizontal (**DWKL1465**)
6. Te 90° (**DWKL317**)
7. Colector de holl6n con desag6e aislado (**DWKL1460**)
8. Abrazadera de amarre por tornillo (**DWXX1063**)
9. Compensador de dilataci6n (**DWKL511**)
10. Codo 90° (**DWKL60**)
11. Adaptador salida embridado (**DWKL856**)

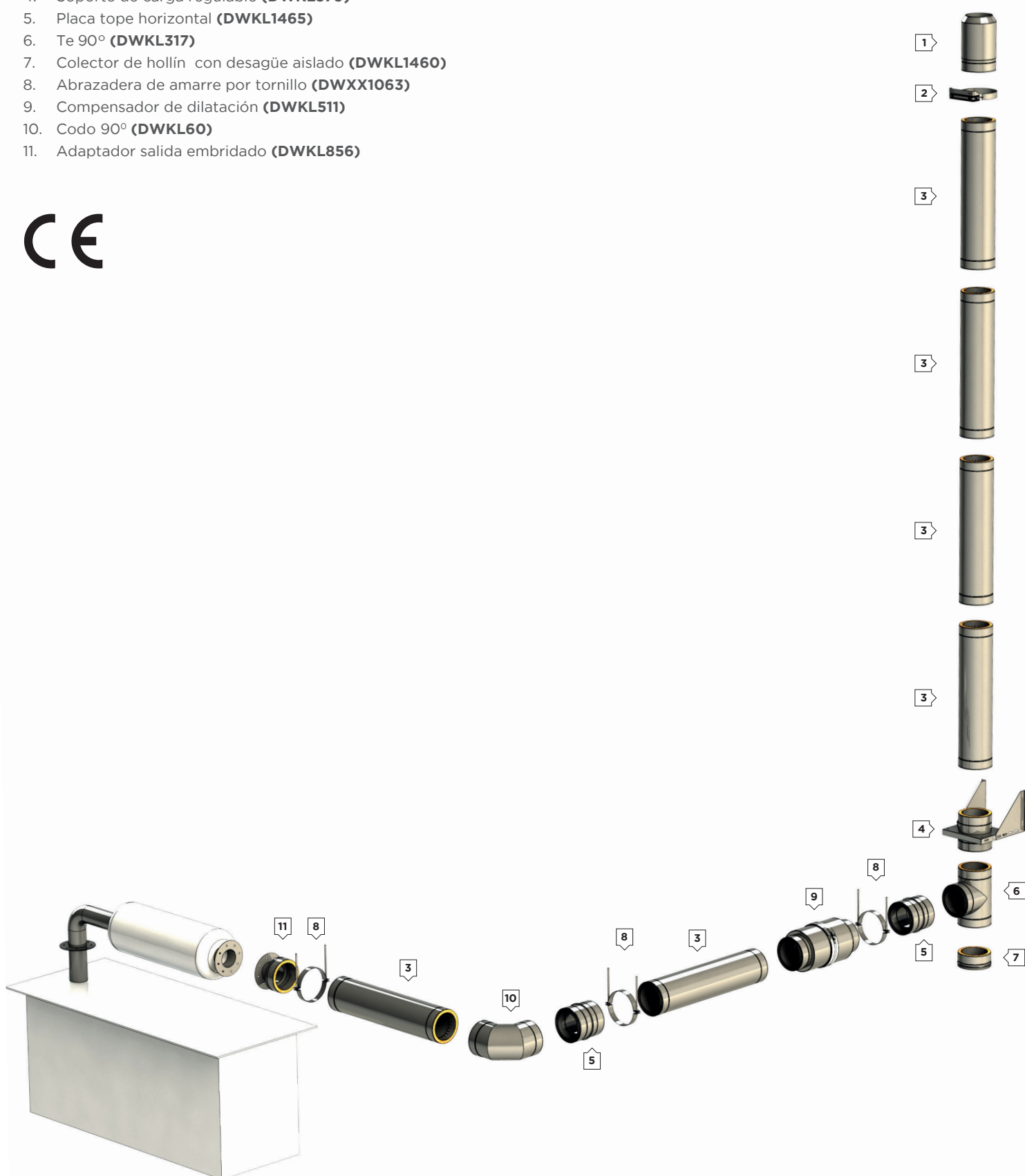



**Chimenea modular metálica para evacuación de humos y gases de los productos de la combustión de doble pared fabricada en acero inoxidable interior y exterior.**

**MATERIAL**

Pared Interior: AISI 304  
Pared Exterior: AISI 304

**ACABADO EXTERIOR**

Brillante  
Colores RAL (consulta página 14 para acabados especiales)

**AISLAMIENTO**

Lana de roca rígida de alta densidad (120kg/m<sup>3</sup>)

**ESPESORES (mm)**

Pared interior: 0,4 - 0,5 - 0,6 - 0,8 (según diámetro)  
Aislamiento: 32 mm (disponible con 25mm, consultar precios y códigos)  
Pared exterior: 0,4 - 0,5 - 0,6 - 0,8 (según diámetro)

**DIÁMETROS DISPONIBLES (mm)**

Ø80 a Ø800

**SISTEMA DE UNIÓN**

Conexión cónica macho-hembra con **abrazadera de unión (2.0)**.

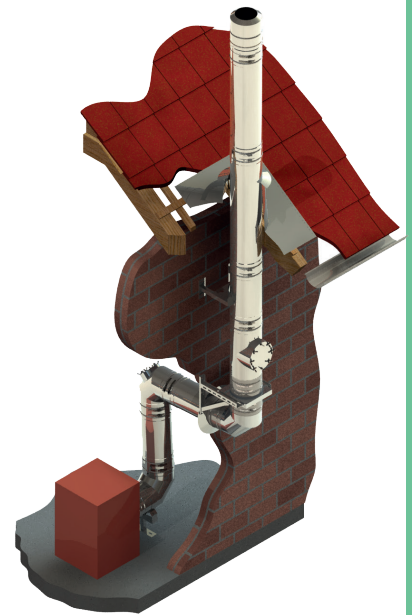

**APLICACIONES**

- Grupos electrógenos
- Microgeneración (CHP)
- Grupos de bombeo
- Extracción de humos y gases
- Calderas sobrepresionadas
- Movimiento de partículas ligeras
- Extracciones químicas (no cloradas)



**CARACTERÍSTICAS**

- Temperatura de trabajo hasta 600°C
- **Soldadura TIG/LÁSER** en continuo en todas las piezas
- **Abrazadera de unión incluida (excepto terminales)**
- Disponible también con AISI 316L interior (adecuado para combustibles con alto contenido en azufre). Consultar precios.
- Chimenea con clasificación de **resistencia al fuego**

**CERTIFICADO CE**

0036 CPR 9174 061

**CLASIFICACIONES CE (UNE-EN 1856-1)**

T600 - N1 - D - Vm - L20040 - G(70)  
T600 - H1 - W - Vm - L20040 - O(50)  
T200 - H1 - W - Vm - L20040 - O(20)  
T200 - P1 - W - Vm - L20040 - O(00)

**CLASIFICACIONES DE RESISTENCIA AL FUEGO SEGÚN EN 13501-2**

EI180 ve (o-->i) T600  
EI180 ho (o-->i) T600



# Sistema DW - KL 32 304

Ver instrucciones de corte página 207



Módulo recto 1000mm



Módulo recto 500mm



Módulo recto 250mm



Módulo recto cortable 200-Módulo recto cortable 200-1000mm



Módulo recto cortable 200-500mm

Ø80	630-DWKL130080	146€	Ø80	630-DWKL140080	106€	Ø80	630-DWKL150080	76€	Ø80	630-DWKL13C0080	177€	Ø80	630-DWKL14C0080	129€
Ø100	630-DWKL130100	156€	Ø100	630-DWKL140100	112€	Ø100	630-DWKL150100	81€	Ø100	630-DWKL13C0100	186€	Ø100	630-DWKL14C0100	138€
Ø130	630-DWKL130130	180€	Ø130	630-DWKL140130	127€	Ø130	630-DWKL150130	91€	Ø130	630-DWKL13C0130	211€	Ø130	630-DWKL14C0130	150€
Ø150	630-DWKL130150	191€	Ø150	630-DWKL140150	127€	Ø150	630-DWKL150150	91€	Ø150	630-DWKL13C0150	233€	Ø150	630-DWKL14C0150	150€
Ø180	630-DWKL130180	221€	Ø180	630-DWKL140180	151€	Ø180	630-DWKL150180	104€	Ø180	630-DWKL13C0180	266€	Ø180	630-DWKL14C0180	180€
Ø200	630-DWKL130200	264€	Ø200	630-DWKL140200	173€	Ø200	630-DWKL150200	122€	Ø200	630-DWKL13C0200	312€	Ø200	630-DWKL14C0200	206€
Ø250	630-DWKL130250	317€	Ø250	630-DWKL140250	202€	Ø250	630-DWKL150250	145€	Ø250	630-DWKL13C0250	378€	Ø250	630-DWKL14C0250	241€
Ø300	630-DWKL130300	387€	Ø300	630-DWKL140300	256€	Ø300	630-DWKL150300	186€	Ø300	630-DWKL13C0300	458€	Ø300	630-DWKL14C0300	306€
Ø350	630-DWKL130350	483€	Ø350	630-DWKL140350	323€	Ø350	630-DWKL150350	249€	Ø350	630-DWKL13C0350	572€	Ø350	630-DWKL14C0350	386€
Ø400	630-DWKL130400	542€	Ø400	630-DWKL140400	387€	Ø400	630-DWKL150400	304€	Ø400	630-DWKL13C0400	648€	Ø400	630-DWKL14C0400	458€
Ø450	630-DWKL130450	565€	Ø450	630-DWKL140450	389€	Ø450	630-DWKL150450	321€	Ø450	630-DWKL13C0450	668€	Ø450	630-DWKL14C0450	461€
Ø500	630-DWKL130500	625€	Ø500	630-DWKL140500	415€	Ø500	630-DWKL150500	364€	Ø500	630-DWKL13C0500	750€	Ø500	630-DWKL14C0500	497€
Ø550	630-DWKL130550	709€	Ø550	630-DWKL140550	538€	Ø550	630-DWKL150550	412€	Ø550	630-DWKL13C0550	846€	Ø550	630-DWKL14C0550	637€
Ø600	630-DWKL130600	936€	Ø600	630-DWKL140600	690€	Ø600	630-DWKL150600	557€	Ø600	630-DWKL13C0600	1120€	Ø600	630-DWKL14C0600	821€
Ø650	630-DWKL130650	1089€	Ø650	630-DWKL140650	798€	Ø650	630-DWKL150650	649€	Ø650	630-DWKL13C0650	1298€	Ø650	630-DWKL14C0650	948€
Ø700	630-DWKL130700	1141€	Ø700	630-DWKL140700	837€	Ø700	630-DWKL150700	681€	Ø700	630-DWKL13C0700	1360€	Ø700	630-DWKL14C0700	992€
Ø750	630-DWKL130750	1212€	Ø750	630-DWKL140750	886€	Ø750	630-DWKL150750	722€	Ø750	630-DWKL13C0750	1443€	Ø750	630-DWKL14C0750	1055€
Ø800	630-DWKL130800	1346€	Ø800	630-DWKL140800	985€	Ø800	630-DWKL150800	801€	Ø800	630-DWKL13C0800	1599€	Ø800	630-DWKL14C0800	1170€



Compensador de dilatación

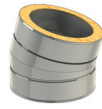

Codo 15°

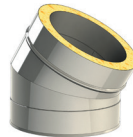

Codo 30°

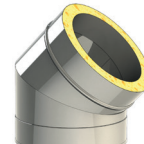

Codo 45°



Codo 60°

Ø80	630-DWKL5110080	687€	Ø80	630-DWKL160080	106€	Ø80	630-DWKL170080	106€	Ø80	630-DWKL180080	106€	Ø80	630-DWKL840080	131€
Ø100	630-DWKL5110100	702€	Ø100	630-DWKL160100	112€	Ø100	630-DWKL170100	112€	Ø100	630-DWKL180100	112€	Ø100	630-DWKL840100	139€
Ø130	630-DWKL5110130	710€	Ø130	630-DWKL160130	127€	Ø130	630-DWKL170130	127€	Ø130	630-DWKL180130	127€	Ø130	630-DWKL840130	155€
Ø150	630-DWKL5110150	849€	Ø150	630-DWKL160150	127€	Ø150	630-DWKL170150	127€	Ø150	630-DWKL180150	127€	Ø150	630-DWKL840150	155€
Ø180	630-DWKL5110180	892€	Ø180	630-DWKL160180	151€	Ø180	630-DWKL170180	151€	Ø180	630-DWKL180180	151€	Ø180	630-DWKL840180	185€
Ø200	630-DWKL5110200	951€	Ø200	630-DWKL160200	173€	Ø200	630-DWKL170200	173€	Ø200	630-DWKL180200	173€	Ø200	630-DWKL840200	211€
Ø250	630-DWKL5110250	1127€	Ø250	630-DWKL160250	202€	Ø250	630-DWKL170250	202€	Ø250	630-DWKL180250	202€	Ø250	630-DWKL840250	249€
Ø300	630-DWKL5110300	1277€	Ø300	630-DWKL160300	244€	Ø300	630-DWKL170300	244€	Ø300	630-DWKL180300	244€	Ø300	630-DWKL840300	312€
Ø350	630-DWKL5110350	1424€	Ø350	630-DWKL160350	329€	Ø350	630-DWKL170350	329€	Ø350	630-DWKL180350	329€	Ø350	630-DWKL840350	400€
Ø400	630-DWKL5110400	1760€	Ø400	630-DWKL160400	417€	Ø400	630-DWKL170400	417€	Ø400	630-DWKL180400	417€			
Ø450	630-DWKL5110450	1912€	Ø450	630-DWKL160450	577€	Ø450	630-DWKL170450	577€	Ø450	630-DWKL180450	577€			
Ø500	630-DWKL5110500	2025€	Ø500	630-DWKL160500	668€	Ø500	630-DWKL170500	668€	Ø500	630-DWKL180500	668€			
Ø550	630-DWKL5110550	2178€	Ø550	630-DWKL160550	934€	Ø550	630-DWKL170550	934€	Ø550	630-DWKL180550	934€			
Ø600	630-DWKL5110600	2555€	Ø600	630-DWKL160600	1303€	Ø600	630-DWKL170600	1303€	Ø600	630-DWKL180600	1303€			
Ø650	630-DWKL5110650	2753€	Ø650	630-DWKL160650	1508€	Ø650	630-DWKL170650	1508€	Ø650	630-DWKL180650	1508€			
Ø700	630-DWKL5110700	2949€	Ø700	630-DWKL160700	1587€	Ø700	630-DWKL170700	1587€	Ø700	630-DWKL180700	1587€			
Ø750	630-DWKL5110750	3631€	Ø750	630-DWKL160750	1682€	Ø750	630-DWKL170750	1682€	Ø750	630-DWKL180750	1682€			
Ø800	630-DWKL5110800	4497€	Ø800	630-DWKL160800	1866€	Ø800	630-DWKL170800	1866€	Ø800	630-DWKL180800	1866€			

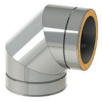

Codo 90°



Te 90°



Te 135°

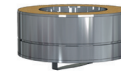

Colector de hollín aislado

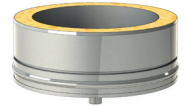

Colector de hollín con desagüe aislado

Ø80	630-DWKL600080	151€	Ø80	630-DWKL3170080	228€	Ø80	630-DWKL120080	311€	Ø80	630-DWKL20330080	50€	Ø80	630-DWKL14600080	76€
Ø100	630-DWKL600100	163€	Ø100	630-DWKL3170100	247€	Ø100	630-DWKL120100	335€	Ø100	630-DWKL20330100	62€	Ø100	630-DWKL14600100	80€
Ø130	630-DWKL600130	183€	Ø130	630-DWKL3170130	274€	Ø130	630-DWKL120130	378€	Ø130	630-DWKL20330130	66€	Ø130	630-DWKL14600130	87€
Ø150	630-DWKL600150	183€	Ø150	630-DWKL3170150	294€	Ø150	630-DWKL120150	397€	Ø150	630-DWKL20330150	74€	Ø150	630-DWKL14600150	96€
Ø180	630-DWKL600180	218€	Ø180	630-DWKL3170180	321€	Ø180	630-DWKL120180	447€	Ø180	630-DWKL20330180	81€	Ø180	630-DWKL14600180	104€
Ø200	630-DWKL600200	249€	Ø200	630-DWKL3170200	375€	Ø200	630-DWKL120200	510€	Ø200	630-DWKL20330200	96€	Ø200	630-DWKL14600200	119€
Ø250	630-DWKL600250	297€	Ø250	630-DWKL3170250	450€	Ø250	630-DWKL120250	701€	Ø250	630-DWKL20330250	112€	Ø250	630-DWKL14600250	137€
Ø300	630-DWKL600300	380€	Ø300	630-DWKL3170300	575€	Ø300	630-DWKL120300	823€	Ø300	630-DWKL20330300	139€	Ø300	630-DWKL14600300	157€
Ø350	630-DWKL600350	472€	Ø350	630-DWKL3170350	723€	Ø350	630-DWKL120350	1028€	Ø350	630-DWKL20330350	151€	Ø350	630-DWKL14600350	205€
			Ø400	630-DWKL3170400	912€	Ø400	630-DWKL120400	1302€	Ø400	630-DWKL20330400	234€	Ø400	630-DWKL14600400	264€
			Ø450	630-DWKL3170450	990€	Ø450	630-DWKL120450	1616€	Ø450	630-DWKL20330450	274€	Ø450	630-DWKL14600450	297€
			Ø500	630-DWKL3170500	1215€	Ø500	630-DWKL120500	1731€	Ø500	630-DWKL20330500	341€	Ø500	630-DWKL14600500	363€
			Ø550	630-DWKL3170550	1310€	Ø550	630-DWKL120550	2796€	Ø550	630-DWKL20330550	413€	Ø550	630-DWKL14600550	437€
			Ø600	630-DWKL3170600	1902€	Ø600	630-DWKL120600	3263€	Ø600	630-DWKL20330600	472€	Ø600	630-DWKL14600600	501€
			Ø650	630-DWKL3170650	2201€	Ø650	630-DWKL120650	3408€	Ø650	630-DWKL20330650	488€	Ø650	630-DWKL14600650	507€
			Ø700	630-DWKL3170700	2310€	Ø700	630-DWKL120700	3577€	Ø700	630-DWKL20330700	503€	Ø700	630-DWKL14600700	527€
			Ø750	630-DWKL3170750	2453€	Ø750	630-DWKL120750	3797€	Ø750	630-DWKL20330750	508€	Ø750	630-DWKL14600750	571€
			Ø800	630-DWKL3170800	2722€	Ø800	630-DWKL120800	4213€	Ø800	630-DWKL20330800	544€	Ø800	630-DWKL14600800	611€



Codo 90° con inspección embreada



Módulo de inspección embreadado



Módulo de medioambiente



Terminal salida libre

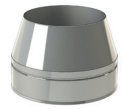

Terminal salida cónica

Ø80	630-DWKL19HT0080	365€	Ø80	630-DWKL10HT0080	274€	Ø130	630-DWKL12680130	670€	Ø80	630-DWKL320080	67€	Ø80	630-DWKL32C0080	80€
Ø100	630-DWKL19HT0100	370€	Ø100	630-DWKL10HT0100	327€	Ø150	630-DWKL12680150	698€	Ø100	630-DWKL320100	76€	Ø100	630-DWKL32C0100	83€
Ø130	630-DWKL19HT0130	379€	Ø130	630-DWKL10HT0130	337€	Ø180	630-DWKL12680180	729€	Ø130	630-DWKL320130	83€	Ø130	630-DWKL32C0130	87€
Ø150	630-DWKL19HT0150	428€	Ø150	630-DWKL10HT0150	356€	Ø200	630-DWKL12680200	758€	Ø150	630-DWKL320150	83€	Ø150	630-DWKL32C0150	99€
Ø180	630-DWKL19HT0180	505€	Ø180	630-DWKL10HT0180	370€	Ø250	630-DWKL12680250	803€	Ø180	630-DWKL320180	98€	Ø180	630-DWKL32C0180	112€
Ø200	630-DWKL19HT0200	590€	Ø200	630-DWKL10HT0200	441€	Ø300	630-DWKL12680300	870€	Ø200	630-DWKL320200	112€	Ø200	630-DWKL32C0200	132€
Ø250	630-DWKL19HT0250	607€	Ø250	630-DWKL10HT0250	586€	Ø350	630-DWKL12680350	1413€	Ø250	630-DWKL320250	133€	Ø250	630-DWKL32C0250	157€
Ø300	630-DWKL19HT0300	776€	Ø300	630-DWKL10HT0300	758€	Ø400	630-DWKL12680400	1507€	Ø300	630-DWKL320300	172€	Ø300	630-DWKL32C0300	202€
Ø350	630-DWKL19HT0350	974€	Ø350	630-DWKL10HT0350	939€	Ø450	630-DWKL12680450	1572€	Ø350	630-DWKL320350	210€	Ø350	630-DWKL32C0350	247€
			Ø400	630-DWKL10HT0400	1180€	Ø500	630-DWKL12680500	1643€	Ø400	630-DWKL320400	269€	Ø400	630-DWKL32C0400	316€
			Ø450	630-DWKL10HT0450	1280€	Ø550	630-DWKL12680550	1774€	Ø450	630-DWKL320450	280€	Ø450	630-DWKL32C0450	341€
			Ø500	630-DWKL10HT0500	1514€	Ø600	630-DWKL12680600	2050€	Ø500	630-DWKL320500	317€	Ø500	630-DWKL32C0500	370€
			Ø550	630-DWKL10HT0550	1610€	Ø650	630-DWKL12680650	2123€	Ø550	630-DWKL320550	333€	Ø550	630-DWKL32C0550	391€
			Ø600	630-DWKL10HT0600	2224€	Ø700	630-DWKL12680700	2171€	Ø600	630-DWKL320600	408€	Ø600	630-DWKL32C0600	397€
			Ø650	630-DWKL10HT0650	2414€	Ø750	630-DWKL12680750	2335€	Ø650	630-DWKL320650	471€	Ø650	630-DWKL32C0650	497€
			Ø700	630-DWKL10HT0700	2541€	Ø800	630-DWKL12680800	2487€	Ø700	630-DWKL320700	496€	Ø700	630-DWKL32C0700	518€
			Ø750	630-DWKL10HT0750	2574€				Ø750	630-DWKL320750	521€	Ø750	630-DWKL32C0750	552€
			Ø800	630-DWKL10HT0800	3421€				Ø800	630-DWKL320800	580€	Ø800	630-DWKL32C0800	617€

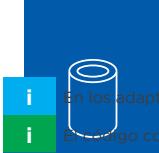

# Sistema DW - KL 32304

En los adaptadores embudados se le dan 2 diámetros a la brida.

El código corresponde al diámetro de salida de la pieza (el mayor en la ampliación y el menor en la reducción)



Terminal anti-lluvia



Terminal horizontal con rejilla



Terminal cónico alta Temperatura



Terminal JET (Alta Temperatura)

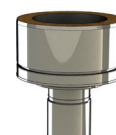

Adaptador caldera hembra (mismo diámetro)

Ø80	630-DWKL5260080	97€	Ø80	630-DWKL5320080	83€	Ø80	630-DWKL32HT0080	97€	Ø80	630-DWKL34HT0080	1023€	Ø80	630-DWKL37H0080	52€
Ø100	630-DWKL5260100	101€	Ø100	630-DWKL5320100	90€	Ø100	630-DWKL32HT0100	117€	Ø100	630-DWKL34HT0100	1059€	Ø100	630-DWKL37H0100	58€
Ø130	630-DWKL5260130	112€	Ø130	630-DWKL5320130	90€	Ø130	630-DWKL32HT0130	117€	Ø130	630-DWKL34HT0130	1144€	Ø130	630-DWKL37H0130	62€
Ø150	630-DWKL5260150	112€	Ø150	630-DWKL5320150	101€	Ø150	630-DWKL32HT0150	117€	Ø150	630-DWKL34HT0150	1193€	Ø150	630-DWKL37H0150	64€
Ø180	630-DWKL5260180	137€	Ø180	630-DWKL5320180	119€	Ø180	630-DWKL32HT0180	133€	Ø180	630-DWKL34HT0180	1340€	Ø180	630-DWKL37H0180	76€
Ø200	630-DWKL5260200	155€	Ø200	630-DWKL5320200	139€	Ø200	630-DWKL32HT0200	156€	Ø200	630-DWKL34HT0200	1481€	Ø200	630-DWKL37H0200	84€
Ø250	630-DWKL5260250	187€	Ø250	630-DWKL5320250	163€	Ø250	630-DWKL32HT0250	210€	Ø250	630-DWKL34HT0250	1882€	Ø250	630-DWKL37H0250	121€
Ø300	630-DWKL5260300	239€	Ø300	630-DWKL5320300	207€	Ø300	630-DWKL32HT0300	272€	Ø300	630-DWKL34HT0300	2156€	Ø300	630-DWKL37H0300	152€
Ø350	630-DWKL5260350	297€	Ø350	630-DWKL5320350	280€	Ø350	630-DWKL32HT0350	337€	Ø350	630-DWKL34HT0350	2501€	Ø350	630-DWKL37H0350	187€
Ø400	630-DWKL5260400	375€	Ø400	630-DWKL5320400	328€	Ø400	630-DWKL32HT0400	425€	Ø400	630-DWKL34HT0400	2814€	Ø400	630-DWKL37H0400	234€
Ø500	630-DWKL5260500	830€	Ø450	630-DWKL5320450	483€	Ø450	630-DWKL32HT0450	461€	Ø450	630-DWKL34HT0450	3196€	Ø450	630-DWKL37H0450	252€
			Ø500	630-DWKL5320500	505€	Ø500	630-DWKL32HT0500	503€	Ø500	630-DWKL34HT0500	3455€	Ø500	630-DWKL37H0500	274€
			Ø550	630-DWKL5320550	715€	Ø550	630-DWKL32HT0550	518€	Ø550	630-DWKL34HT0550	4257€	Ø550	630-DWKL37H0550	337€
			Ø600	630-DWKL5320600	873€	Ø600	630-DWKL32HT0600	603€	Ø600	630-DWKL34HT0600	4945€	Ø600	630-DWKL37H0600	401€
			Ø650	630-DWKL5320650	888€	Ø650	630-DWKL32HT0650	611€	Ø650	630-DWKL34HT0650	5262€	Ø650	630-DWKL37H0650	413€
			Ø700	630-DWKL5320700	923€	Ø700	630-DWKL32HT0700	616€	Ø700	630-DWKL34HT0700	5598€	Ø700	630-DWKL37H0700	437€
			Ø750	630-DWKL5320750	997€	Ø750	630-DWKL32HT0750	653€	Ø750	630-DWKL34HT0750	6251€	Ø750	630-DWKL37H0750	461€
			Ø800	630-DWKL5320800	1066€	Ø800	630-DWKL32HT0800	726€	Ø800	630-DWKL34HT0800	6674€	Ø800	630-DWKL37H0800	510€

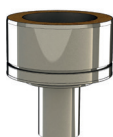

Adaptador caldera macho (mismo diámetro)

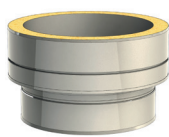

Ampliación (1 diámetro)

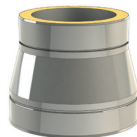

Reducción (1 diámetro)

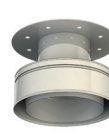

Adaptador embreado entrada

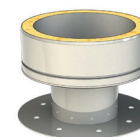

Adaptador embreado salida

Ø80	630-DWKL37M0080	52€	Ø100	630-DWKL9830100	112€	Ø80	630-DWKL9820080	101€	Ø80	630-DWKL9710080	100€	Ø80	630-DWKL8560080	100€
Ø100	630-DWKL37M0100	58€	Ø130	630-DWKL9830130	127€	Ø100	630-DWKL9820100	112€	Ø100	630-DWKL9710100	129€	Ø100	630-DWKL8560100	129€
Ø130	630-DWKL37M0130	62€	Ø150	630-DWKL9830150	161€	Ø130	630-DWKL9820130	127€	Ø130	630-DWKL9710130	132€	Ø130	630-DWKL8560130	132€
Ø150	630-DWKL37M0150	64€	Ø180	630-DWKL9830180	196€	Ø150	630-DWKL9820150	161€	Ø150	630-DWKL9710150	140€	Ø150	630-DWKL8560150	140€
Ø180	630-DWKL37M0180	76€	Ø200	630-DWKL9830200	244€	Ø180	630-DWKL9820180	196€	Ø180	630-DWKL9710180	169€	Ø180	630-DWKL8560180	169€
Ø200	630-DWKL37M0200	84€	Ø250	630-DWKL9830250	304€	Ø200	630-DWKL9820200	244€	Ø200	630-DWKL9710200	190€	Ø200	630-DWKL8560200	190€
Ø250	630-DWKL37M0250	121€	Ø300	630-DWKL9830300	351€	Ø250	630-DWKL9820250	304€	Ø250	630-DWKL9710250	270€	Ø250	630-DWKL8560250	270€
Ø300	630-DWKL37M0300	152€	Ø350	630-DWKL9830350	415€	Ø300	630-DWKL9820300	351€	Ø300	630-DWKL9710300	341€	Ø300	630-DWKL8560300	341€
Ø350	630-DWKL37M0350	187€	Ø400	630-DWKL9830400	508€	Ø350	630-DWKL9820350	415€	Ø350	630-DWKL9710350	420€	Ø350	630-DWKL8560350	420€
Ø400	630-DWKL37M0400	234€	Ø450	630-DWKL9830450	695€	Ø400	630-DWKL9820400	508€	Ø400	630-DWKL9710400	517€	Ø400	630-DWKL8560400	517€
Ø450	630-DWKL37M0450	252€	Ø500	630-DWKL9830500	785€	Ø450	630-DWKL9820450	695€	Ø450	630-DWKL9710450	590€	Ø450	630-DWKL8560450	590€
Ø500	630-DWKL37M0500	274€	Ø550	630-DWKL9830550	828€	Ø500	630-DWKL9820500	785€	Ø500	630-DWKL9710500	667€	Ø500	630-DWKL8560500	667€
Ø550	630-DWKL37M0550	337€	Ø600	630-DWKL9830600	1119€	Ø550	630-DWKL9820550	828€	Ø550	630-DWKL9710550	728€	Ø550	630-DWKL8560550	728€
Ø600	630-DWKL37M0600	401€	Ø650	630-DWKL9830650	1293€	Ø600	630-DWKL9820600	1119€	Ø600	630-DWKL9710600	838€	Ø600	630-DWKL8560600	838€
Ø650	630-DWKL37M0650	413€	Ø700	630-DWKL9830700	1357€	Ø650	630-DWKL9820650	1293€	Ø650	630-DWKL9710650	933€	Ø650	630-DWKL8560650	933€
Ø700	630-DWKL37M0700	437€	Ø750	630-DWKL9830750	1441€	Ø700	630-DWKL9820700	1357€	Ø700	630-DWKL9710700	983€	Ø700	630-DWKL8560700	983€
Ø750	630-DWKL37M0750	461€	Ø800	630-DWKL9830800	1594€	Ø750	630-DWKL9820750	1441€	Ø750	630-DWKL9710750	1037€	Ø750	630-DWKL8560750	1037€
Ø800	630-DWKL37M0800	510€							Ø800	630-DWKL9710800	1158€	Ø800	630-DWKL8560800	1158€



Adaptador para soldar (mismo diámetro)



Placa tope

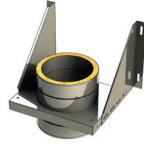

Soporte de carga regulable

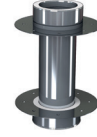

Pasamuros EI



Abrazadera de unión 2.0

Ø80	630-DWKL20490080	52€	Ø80	630-DWKL14650080	150€	Ø80	630-DWKL3790080	187€	Ø80	630-DWKL43300080	471€	Ø80	665-ZUWA9890145	11.38€
Ø100	630-DWKL20490100	62€	Ø100	630-DWKL14650100	152€	Ø100	630-DWKL3790100	196€	Ø100	630-DWKL43300100	486€	Ø100	665-ZUWA9890165	14.65€
Ø130	630-DWKL20490130	76€	Ø130	630-DWKL14650130	156€	Ø130	630-DWKL3790130	200€	Ø130	630-DWKL43300130	543€	Ø130	665-ZUWA9890195	17.9€
Ø150	630-DWKL20490150	78€	Ø150	630-DWKL14650150	180€	Ø150	630-DWKL3790150	226€	Ø150	630-DWKL43300150	499€	Ø150	665-ZUWA9890215	19.51€
Ø180	630-DWKL20490180	91€	Ø180	630-DWKL14650180	205€	Ø180	630-DWKL3790180	260€	Ø180	630-DWKL43300180	572€	Ø180	665-ZUWA9890245	24.4€
Ø200	630-DWKL20490200	101€	Ø200	630-DWKL14650200	244€	Ø200	630-DWKL3790200	298€	Ø200	630-DWKL43300200	650€	Ø200	665-ZUWA9890265	27.67€
Ø250	630-DWKL20490250	127€	Ø250	630-DWKL14650250	306€	Ø250	630-DWKL3790250	358€	Ø250	630-DWKL43300250	737€	Ø250	665-ZUWA9890315	32.52€
Ø300	630-DWKL20490300	137€	Ø300	630-DWKL14650300	398€	Ø300	630-DWKL3790300	468€	Ø300	630-DWKL43300300	838€	Ø300	665-ZUWA9890365	37.43€
Ø350	630-DWKL20490350	184€	Ø350	630-DWKL14650350	494€	Ø350	630-DWKL3790350	580€	Ø350	630-DWKL43300350	961€	Ø350	665-ZUWA9890415	47.13€
Ø400	630-DWKL20490400	228€	Ø400	630-DWKL14650400	620€	Ø400	630-DWKL3790400	726€	Ø400	630-DWKL43300400	1125€	Ø400	665-ZUWA9890465	52€
Ø450	630-DWKL20490450	247€	Ø450	630-DWKL14650450	667€	Ø450	630-DWKL3790450	787€	Ø450	630-DWKL43300450	1246€	Ø450	665-ZUWA9890515	56€
Ø500	630-DWKL20490500	286€	Ø500	630-DWKL14650500	728€	Ø500	630-DWKL3790500	862€	Ø500	630-DWKL43300500	1442€	Ø500	665-ZUWA9890565	64€
Ø550	630-DWKL20490550	351€	Ø550	630-DWKL14650550	838€	Ø550	630-DWKL3790550	987€	Ø550	630-DWKL43300550	1549€	Ø550	665-ZUWA9890615	71€
Ø600	630-DWKL20490600	466€	Ø600	630-DWKL14650600	1046€	Ø600	630-DWKL3790600	1212€	Ø600	630-DWKL43300600	1829€	Ø600	665-ZUWA9890665	74€
Ø650	630-DWKL20490650	529€	Ø650	630-DWKL14650650	1056€	Ø650	630-DWKL3790650	1224€	Ø650	630-DWKL43300650	1815€	Ø650	665-ZUWA9890715	96€
Ø700	630-DWKL20490700	556€	Ø700	630-DWKL14650700	1070€	Ø700	630-DWKL3790700	1237€	Ø700	630-DWKL43300700	2014€	Ø700	665-ZUWA9890765	107€
Ø750	630-DWKL20490750	586€	Ø750	630-DWKL14650750	1135€	Ø750	630-DWKL3790750	1313€	Ø750	630-DWKL43300750	2179€	Ø750	665-ZUWA9890815	114€
Ø800	630-DWKL20490800	647€	Ø800	630-DWKL14650800	1255€	Ø800	630-DWKL3790800	1458€	Ø800	630-DWKL43300800	2275€	Ø800	665-ZUWA9890865	121€

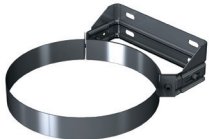

Abrazadera fijación pared regulable 50-80mm

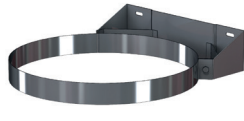

Abrazadera fijación pared fija



Base de abrazadera distanciadora



Alas distanciadoras A



Alas distanciadoras B

Ø80	665-ZUWA5560145	39.04€	Ø450	665-ZUWA556F0515	141€	Ø80	665-ZUWA14620145	48.72€	Ø80	665-ZUWA1462A	47.13€	Ø80	665-ZUWA1462B	65€
Ø100	665-ZUWA5560165	39.04€	Ø500	665-ZUWA556F0565	169€	Ø100	665-ZUWA14620165	50€	Ø100	665-ZUWA1462A	47.13€	Ø100	665-ZUWA1462B	65€
Ø130	665-ZUWA5560195	45.58€	Ø550	665-ZUWA556F0615	191€	Ø130	665-ZUWA14620195	54€	Ø130	665-ZUWA1462A	47.13€	Ø130	665-ZUWA1462B	65€
Ø150	665-ZUWA5560215	48.72€	Ø600	665-ZUWA556F0665	207€	Ø150	665-ZUWA14620215	65€	Ø150	665-ZUWA1462A	47.13€	Ø150	665-ZUWA1462B	65€
Ø180	665-ZUWA5560245	56€	Ø650	665-ZUWA556F0715	290€	Ø180	665-ZUWA14620245	98€	Ø180	665-ZUWA1462A	47.13€	Ø180	665-ZUWA1462B	65€
Ø200	665-ZUWA5560265	64€	Ø700	665-ZUWA556F0765	337€	Ø200	665-ZUWA14620265	112€	Ø200	665-ZUWA1462A	47.13€	Ø200	665-ZUWA1462B	65€
Ø250	665-ZUWA5560315	66€	Ø750	665-ZUWA556F0815	367€	Ø250	665-ZUWA14620315	146€	Ø250	665-ZUWA1462A	47.13€	Ø250	665-ZUWA1462B	65€
Ø300	665-ZUWA5560365	78€	Ø800	665-ZUWA556F0865	387€	Ø300	665-ZUWA14620365	203€	Ø300	665-ZUWA1462A	47.13€	Ø300	665-ZUWA1462B	65€
Ø350	665-ZUWA5560415	95€				Ø350	665-ZUWA14620415	268€	Ø350	665-ZUWA1462A	47.13€	Ø350	665-ZUWA1462B	65€
Ø400	665-ZUWA5560465	111€				Ø400	665-ZUWA14620465	313€	Ø400	665-ZUWA1462A	47.13€	Ø400	665-ZUWA1462B	65€
						Ø450	665-ZUWA14620515	337€	Ø450	665-ZUWA1462A	47.13€	Ø450	665-ZUWA1462B	65€
						Ø500	665-ZUWA14620565	386€	Ø500	665-ZUWA1462A	47.13€	Ø500	665-ZUWA1462B	65€
						Ø550	665-ZUWA14620615	453€	Ø550	665-ZUWA1462A	47.13€	Ø550	665-ZUWA1462B	65€
						Ø600	665-ZUWA14620665	489€	Ø600	665-ZUWA1462A	47.13€	Ø600	665-ZUWA1462B	65€
						Ø650	665-ZUWA14620715	580€	Ø650	665-ZUWA1462A	47.13€	Ø650	665-ZUWA1462B	65€
						Ø700	665-ZUWA14620765	688€	Ø700	665-ZUWA1462A	47.13€	Ø700	665-ZUWA1462B	65€
						Ø750	665-ZUWA14620815	812€	Ø750	665-ZUWA1462A	47.13€	Ø750	665-ZUWA1462B	65€
						Ø800	665-ZUWA14620865	850€	Ø800	665-ZUWA1462A	47.13€	Ø800	665-ZUWA1462B	65€



## Sistema DW - KL 32 304

En los adaptadores en U se fijan los soportes de aluminio y de las alas mediante una brida.

Consultar página 91 para ver distancias de separación.



Alas distanciadoras C



Alas distanciadoras D

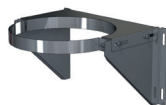

Abrazadera de soporte



Abrazadera con doble pértiga telescópica L=2000mm

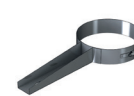

Abrazadera forjado inox

Ø80	665-ZUWA1462C	81€	Ø80	665-ZUWA1462D	104€	Ø100	665-ZUWA8580165	145€	Ø80	665-ZUWA1910145	145€	Ø80	665-ZUWA620145	29.27€
Ø100	665-ZUWA1462C	81€	Ø100	665-ZUWA1462D	104€	Ø130	665-ZUWA8580195	145€	Ø100	665-ZUWA1910165	150€	Ø100	665-ZUWA620165	34.15€
Ø130	665-ZUWA1462C	81€	Ø130	665-ZUWA1462D	104€	Ø150	665-ZUWA8580215	157€	Ø130	665-ZUWA1910195	173€	Ø130	665-ZUWA620195	47.13€
Ø150	665-ZUWA1462C	81€	Ø150	665-ZUWA1462D	104€	Ø180	665-ZUWA8580245	179€	Ø150	665-ZUWA1910215	174€	Ø150	665-ZUWA620215	50€
Ø180	665-ZUWA1462C	81€	Ø180	665-ZUWA1462D	104€	Ø200	665-ZUWA8580265	199€	Ø180	665-ZUWA1910245	183€	Ø180	665-ZUWA620245	50€
Ø200	665-ZUWA1462C	81€	Ø200	665-ZUWA1462D	104€	Ø250	665-ZUWA8580315	218€	Ø200	665-ZUWA1910265	228€	Ø200	665-ZUWA620265	56€
Ø250	665-ZUWA1462C	81€	Ø250	665-ZUWA1462D	104€	Ø300	665-ZUWA8580365	252€	Ø250	665-ZUWA1910315	244€	Ø250	665-ZUWA620315	65€
Ø300	665-ZUWA1462C	81€	Ø300	665-ZUWA1462D	104€	Ø350	665-ZUWA8580415	304€	Ø300	665-ZUWA1910365	269€	Ø300	665-ZUWA620365	73€
Ø350	665-ZUWA1462C	81€	Ø350	665-ZUWA1462D	104€	Ø400	665-ZUWA8580465	343€	Ø350	665-ZUWA1910415	358€	Ø350	665-ZUWA620415	81€
Ø400	665-ZUWA1462C	81€	Ø400	665-ZUWA1462D	104€	Ø450	665-ZUWA8580515	386€	Ø400	665-ZUWA1910465	489€	Ø400	665-ZUWA620465	90€
Ø450	665-ZUWA1462C	81€	Ø450	665-ZUWA1462D	104€	Ø500	665-ZUWA8580565	437€	Ø450	665-ZUWA1910515	640€	Ø450	665-ZUWA620515	98€
Ø500	665-ZUWA1462C	81€	Ø500	665-ZUWA1462D	104€	Ø550	665-ZUWA8580615	479€	Ø500	665-ZUWA1910565	684€	Ø500	665-ZUWA620565	105€
Ø550	665-ZUWA1462C	81€	Ø550	665-ZUWA1462D	104€	Ø600	665-ZUWA8580665	505€	Ø550	665-ZUWA1910615	758€	Ø550	665-ZUWA620615	111€
Ø600	665-ZUWA1462C	81€	Ø600	665-ZUWA1462D	104€	Ø650	665-ZUWA8580715	706€	Ø600	665-ZUWA1910665	868€	Ø600	665-ZUWA620665	117€
Ø650	665-ZUWA1462C	81€	Ø650	665-ZUWA1462D	104€	Ø700	665-ZUWA8580765	825€	Ø650	665-ZUWA1910715	930€			
Ø700	665-ZUWA1462C	81€	Ø700	665-ZUWA1462D	104€	Ø750	665-ZUWA8580815	899€	Ø700	665-ZUWA1910765	1055€			
Ø750	665-ZUWA1462C	81€	Ø750	665-ZUWA1462D	104€	Ø800	665-ZUWA8580865	943€	Ø750	665-ZUWA1910815	1164€			
Ø800	665-ZUWA1462C	81€	Ø800	665-ZUWA1462D	104€				Ø800	665-ZUWA1910865	1222€			



Abrazadera para amarre por tornillo



Abrazadera vientos



Gancho y pletina para módulo de medioambiente



Soporte de techo



Collarín antitormenta

Ø80	665-ZUWA10630145	35.77€	Ø80	665-ZUWA420145	14.65€	Ø80	665-ZUWA43940145	146€	Ø80	665-ZUWA9360145	37.43€	Ø80	665-ZUWA3070145	30.9€
Ø100	665-ZUWA10630165	37.43€	Ø100	665-ZUWA420165	17.9€	Ø100	665-ZUWA43940165	151€	Ø100	665-ZUWA9360165	45.58€	Ø100	665-ZUWA3070165	37.43€
Ø130	665-ZUWA10630195	42.42€	Ø130	665-ZUWA420195	26.04€	Ø130	665-ZUWA43940195	161€	Ø130	665-ZUWA9360195	56€	Ø130	665-ZUWA3070195	47.13€
Ø150	665-ZUWA10630215	45.58€	Ø150	665-ZUWA420215	27.67€	Ø150	665-ZUWA43940215	166€	Ø150	665-ZUWA9360215	64€	Ø150	665-ZUWA3070215	50€
Ø180	665-ZUWA10630245	50€	Ø180	665-ZUWA420245	29.27€	Ø180	665-ZUWA43940245	178€	Ø180	665-ZUWA9360245	71€	Ø180	665-ZUWA3070245	56€
Ø200	665-ZUWA10630265	52€	Ø200	665-ZUWA420265	30.9€	Ø200	665-ZUWA43940265	180€	Ø200	665-ZUWA9360265	80€	Ø200	665-ZUWA3070265	67€
Ø250	665-ZUWA10630315	67€	Ø250	665-ZUWA420315	37.43€	Ø250	665-ZUWA43940315	215€	Ø250	665-ZUWA9360315	95€	Ø250	665-ZUWA3070315	74€
Ø300	665-ZUWA10630365	77€	Ø300	665-ZUWA420365	40.87€	Ø300	665-ZUWA43940365	231€	Ø300	665-ZUWA9360365	104€	Ø300	665-ZUWA3070365	81€
Ø350	665-ZUWA10630415	88€	Ø350	665-ZUWA420415	45.58€	Ø350	665-ZUWA43940415	323€	Ø350	665-ZUWA9360415	111€	Ø350	665-ZUWA3070415	109€
Ø400	665-ZUWA10630465	97€	Ø400	665-ZUWA420465	64€	Ø400	665-ZUWA43940465	343€	Ø400	665-ZUWA9360465	156€	Ø400	665-ZUWA3070465	150€
Ø450	665-ZUWA10630515	107€	Ø450	665-ZUWA420515	81€	Ø450	665-ZUWA43940515	366€	Ø450	665-ZUWA9360515	204€	Ø450	665-ZUWA3070515	196€
Ø500	665-ZUWA10630565	117€	Ø500	665-ZUWA420565	104€	Ø500	665-ZUWA43940565	389€	Ø500	665-ZUWA9360565	261€	Ø500	665-ZUWA3070565	206€
Ø550	665-ZUWA10630615	131€	Ø550	665-ZUWA420615	112€	Ø550	665-ZUWA43940615	410€	Ø550	665-ZUWA9360615	282€	Ø550	665-ZUWA3070615	233€
Ø600	665-ZUWA10630665	140€	Ø600	665-ZUWA420665	129€	Ø600	665-ZUWA43940665	431€	Ø600	665-ZUWA9360665	316€	Ø600	665-ZUWA3070665	266€
Ø650	665-ZUWA10630715	157€	Ø650	665-ZUWA420715	168€	Ø650	665-ZUWA43940715	470€	Ø650	665-ZUWA9360715	351€	Ø650	665-ZUWA3070715	283€
Ø700	665-ZUWA10630765	173€	Ø700	665-ZUWA420765	196€	Ø700	665-ZUWA43940765	497€	Ø700	665-ZUWA9360765	397€	Ø700	665-ZUWA3070765	321€
Ø750	665-ZUWA10630815	185€	Ø750	665-ZUWA420815	210€	Ø750	665-ZUWA43940815	520€	Ø750	665-ZUWA9360815	437€	Ø750	665-ZUWA3070815	356€
Ø800	665-ZUWA10630865	191€	Ø800	665-ZUWA420865	220€	Ø800	665-ZUWA43940865	539€	Ø800	665-ZUWA9360865	456€	Ø800	665-ZUWA3070865	369€



# Sistema DW - KL 32 304

**i** Necesario instalar collarín con el cubreaguas.

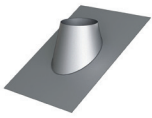

Cubreaguas 25°-45° aluminio

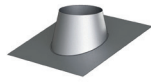

Cubreaguas 5°-25° aluminio

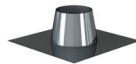

Cubreaguas plano inox

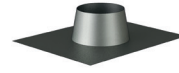

Cubreaguas plomo 0°-5°

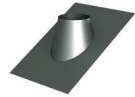

Cubreaguas plomo 25°-45°

Ø80	665-ZUWA939AL0145	233€	Ø80	665-ZUWA938AL0145	215€	Ø80	665-ZUWA11280145	146€	Ø80	665-ZUWA9370145	205€	Ø80	665-ZUWA9390145	358€
Ø100	665-ZUWA939AL0165	233€	Ø100	665-ZUWA938AL0165	226€	Ø100	665-ZUWA11280165	150€	Ø100	665-ZUWA9370165	206€	Ø100	665-ZUWA9390165	363€
Ø130	665-ZUWA939AL0195	269€	Ø130	665-ZUWA938AL0195	252€	Ø130	665-ZUWA11280195	170€	Ø130	665-ZUWA9370195	260€	Ø130	665-ZUWA9390195	386€
Ø150	665-ZUWA939AL0215	269€	Ø150	665-ZUWA938AL0215	252€	Ø150	665-ZUWA11280215	185€	Ø150	665-ZUWA9370215	260€	Ø150	665-ZUWA9390215	386€
Ø180	665-ZUWA939AL0245	305€	Ø180	665-ZUWA938AL0245	282€	Ø180	665-ZUWA11280245	191€	Ø180	665-ZUWA9370245	269€	Ø180	665-ZUWA9390245	397€
Ø200	665-ZUWA939AL0265	305€	Ø200	665-ZUWA938AL0265	282€	Ø200	665-ZUWA11280265	211€	Ø200	665-ZUWA9370265	294€	Ø200	665-ZUWA9390265	401€
Ø250	665-ZUWA939AL0315	332€	Ø250	665-ZUWA938AL0315	318€	Ø250	665-ZUWA11280315	233€	Ø250	665-ZUWA9370315	323€	Ø250	665-ZUWA9390315	417€
Ø300	665-ZUWA939AL0365	387€	Ø300	665-ZUWA938AL0365	368€	Ø300	665-ZUWA11280365	260€	Ø300	665-ZUWA9370365	361€	Ø300	665-ZUWA9390365	431€
Ø350	665-ZUWA939AL0415	433€	Ø350	665-ZUWA938AL0415	411€	Ø350	665-ZUWA11280415	286€	Ø350	665-ZUWA9370415	396€	Ø350	665-ZUWA9390415	454€
Ø400	665-ZUWA939AL0465	492€	Ø400	665-ZUWA938AL0465	481€	Ø400	665-ZUWA11280465	306€	Ø400	665-ZUWA9370465	428€	Ø400	665-ZUWA9390465	541€
Ø450	665-ZUWA939AL0515	575€	Ø450	665-ZUWA938AL0515	502€	Ø450	665-ZUWA11280515	352€	Ø450	665-ZUWA9370515	488€	Ø450	665-ZUWA9390515	618€
Ø500	665-ZUWA939AL0565	618€	Ø500	665-ZUWA938AL0565	539€	Ø500	665-ZUWA11280565	389€	Ø500	665-ZUWA9370565	539€	Ø500	665-ZUWA9390565	691€
Ø550	665-ZUWA939AL0615	679€	Ø550	665-ZUWA938AL0615	586€	Ø550	665-ZUWA11280615	437€	Ø550	665-ZUWA9370615	606€	Ø550	665-ZUWA9390615	775€
Ø600	665-ZUWA939AL0665	746€	Ø600	665-ZUWA938AL0665	652€	Ø600	665-ZUWA11280665	492€	Ø600	665-ZUWA9370665	684€	Ø600	665-ZUWA9390665	869€
Ø650	665-ZUWA939AL0715	852€	Ø650	665-ZUWA938AL0715	684€	Ø650	665-ZUWA11280715	570€	Ø650	665-ZUWA9370715	789€	Ø650	665-ZUWA9390715	1006€
Ø700	665-ZUWA939AL0765	950€	Ø700	665-ZUWA938AL0765	785€	Ø700	665-ZUWA11280765	598€	Ø700	665-ZUWA9370765	832€	Ø700	665-ZUWA9390765	1057€
Ø750	665-ZUWA939AL0815	1192€	Ø750	665-ZUWA938AL0815	918€	Ø750	665-ZUWA11280815	633€	Ø750	665-ZUWA9370815	880€	Ø750	665-ZUWA9390815	1115€
Ø800	665-ZUWA939AL0865	1297€	Ø800	665-ZUWA938AL0865	1055€	Ø800	665-ZUWA11280865	662€	Ø800	665-ZUWA9370865	920€	Ø800	665-ZUWA9390865	1168€

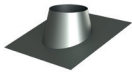

Cubreaguas plomo 5°-25°



Pasamuros



Pasta KL



Disco madera KL agujero Ø12 a 5cm del borde

Ø80	665-ZUWA9380145	205€	Ø80	665-ZUWA9870145	40.87€	Ø80	KL PASTE	49.71€	Ø80	665-ZUWA20350080	#N/A€
Ø100	665-ZUWA9380165	206€	Ø100	665-ZUWA9870165	45.58€	Ø100	KL PASTE	49.71€	Ø100	665-ZUWA20350100	90€
Ø130	665-ZUWA9380195	260€	Ø130	665-ZUWA9870195	52€	Ø130	KL PASTE	49.71€	Ø130	665-ZUWA20350130	#N/A€
Ø150	665-ZUWA9380215	260€	Ø150	665-ZUWA9870215	59€	Ø150	KL PASTE	49.71€	Ø150	665-ZUWA20350150	#N/A€
Ø180	665-ZUWA9380245	269€	Ø180	665-ZUWA9870245	65€	Ø180	KL PASTE	49.71€	Ø180	665-ZUWA20350180	#N/A€
Ø200	665-ZUWA9380265	294€	Ø200	665-ZUWA9870265	77€	Ø200	KL PASTE	49.71€	Ø200	665-ZUWA20350200	98€
Ø250	665-ZUWA9380315	323€	Ø250	665-ZUWA9870315	88€	Ø250	KL PASTE	49.71€	Ø250	665-ZUWA20350250	#N/A€
Ø300	665-ZUWA9380365	361€	Ø300	665-ZUWA9870365	111€	Ø300	KL PASTE	49.71€	Ø300	665-ZUWA20350300	#N/A€
Ø350	665-ZUWA9380415	396€	Ø350	665-ZUWA9870415	145€	Ø350	KL PASTE	49.71€	Ø350	665-ZUWA20350350	160€
Ø400	665-ZUWA9380465	428€	Ø400	665-ZUWA9870465	183€	Ø400	KL PASTE	49.71€	Ø400	665-ZUWA20350400	#N/A€
Ø450	665-ZUWA9380515	488€	Ø450	665-ZUWA9870515	211€	Ø450	KL PASTE	49.71€	Ø450	665-ZUWA20350450	160€
Ø500	665-ZUWA9380565	539€	Ø500	665-ZUWA9870565	235€	Ø500	KL PASTE	49.71€	Ø500	665-ZUWA20350500	241€
Ø550	665-ZUWA9380615	606€	Ø550	665-ZUWA9870615	264€	Ø550	KL PASTE	49.71€	Ø550	665-ZUWA20350550	241€
Ø600	665-ZUWA9380665	684€	Ø600	665-ZUWA9870665	294€	Ø600	KL PASTE	49.71€	Ø600	665-ZUWA20350600	408€
Ø650	665-ZUWA9380715	789€	Ø650	665-ZUWA9870715	367€	Ø650	KL PASTE	49.71€	Ø650	665-ZUWA20350650	408€
Ø700	665-ZUWA9380765	832€	Ø700	665-ZUWA9870765	433€	Ø700	KL PASTE	49.71€	Ø700	665-ZUWA20350700	408€
Ø750	665-ZUWA9380815	880€	Ø750	665-ZUWA9870815	483€	Ø750	KL PASTE	49.71€	Ø750	665-ZUWA20350750	496€
Ø800	665-ZUWA9380865	920€	Ø800	665-ZUWA9870865	504€	Ø800	KL PASTE	49.71€	Ø800	665-ZUWA20350800	496€



**Chimenea modular metálica para evacuación de humos y gases de los productos de la combustión de doble pared fabricada en acero inoxidable interior y exterior.**

### MATERIAL

Pared Interior: AISI 304  
Pared Exterior: AISI 304

### ACABADO EXTERIOR

Brillante  
Colores RAL (consulta página 14 para acabados especiales)

### AISLAMIENTO

Lana de roca rígida de alta densidad (120kg/m<sup>3</sup>)

### ESPEORES (mm)

Pared interior: 0,4 - 0,5 - 0,6 - 0,8 (según diámetro)  
Aislamiento: 50 mm (disponible con 25mm, consultar precios y códigos)  
Pared exterior: 0,4 - 0,5 - 0,6 - 0,8 (según diámetro)

### DIÁMETROS DISPONIBLES (mm)

Ø150 a Ø800

### SISTEMA DE UNIÓN

Conexión cónica macho-hembra con **abrazadera de unión ancha (2.0)**



### APLICACIONES

- Cogeneración
- Grupos electrógenos en zonas habitadas
- Incineradoras
- Hornos de secado
- Calderas sobrepresionadas



### CARACTERÍSTICAS

- Temperatura de trabajo hasta 600°C
- **Soldadura TIG/LÁSER** en continuo en todas las piezas
- **Abrazadera de unión incluida (excepto terminales)**
- Disponible también con AISI 316L interior (adecuado para combustibles con alto contenido en azufre). Consultar precios
- Chimenea con clasificación de **resistencia al fuego**

### CERTIFICADO CE

0036 CPR 9174 061

### CLASIFICACIONES CE (UNE-EN 1856-1)

T600 - N1 - D - Vm - L20040 - G(70)  
T600 - H1 - W - Vm - L20040 - O(50)  
T200 - H1 - W - Vm - L20040 - O(20)  
T200 - P1 - W - Vm - L20040 - O(00)

### CLASIFICACIONES DE RESISTENCIA AL FUEGO SEGÚN EN 13501-2

EI180 ve (o-->i) T600  
EI180 ho (o-->i) T600



Módulo recto 1000mm



Módulo recto 500mm



Módulo recto 250mm



Módulo recto cortable 200-  
1000mm



Módulo recto cortable 200-  
500mm

Ø80	636-DWKL130080	184€	Ø80	636-DWKL140080	133€	Ø80	636-DWKL150080	96€	Ø80	636-DWKL13C0080	219€	Ø80	636-DWKL14C0080	157€
Ø100	636-DWKL130100	210€	Ø100	636-DWKL140100	155€	Ø100	636-DWKL150100	109€	Ø100	636-DWKL13C0100	250€	Ø100	636-DWKL14C0100	184€
Ø130	636-DWKL130130	226€	Ø130	636-DWKL140130	157€	Ø130	636-DWKL150130	112€	Ø130	636-DWKL13C0130	269€	Ø130	636-DWKL14C0130	187€
Ø150	636-DWKL130150	242€	Ø150	636-DWKL140150	168€	Ø150	636-DWKL150150	122€	Ø150	636-DWKL13C0150	287€	Ø150	636-DWKL14C0150	207€
Ø180	636-DWKL130180	272€	Ø180	636-DWKL140180	186€	Ø180	636-DWKL150180	132€	Ø180	636-DWKL13C0180	327€	Ø180	636-DWKL14C0180	222€
Ø200	636-DWKL130200	321€	Ø200	636-DWKL140200	211€	Ø200	636-DWKL150200	146€	Ø200	636-DWKL13C0200	380€	Ø200	636-DWKL14C0200	251€
Ø250	636-DWKL130250	431€	Ø250	636-DWKL140250	275€	Ø250	636-DWKL150250	200€	Ø250	636-DWKL13C0250	516€	Ø250	636-DWKL14C0250	329€
Ø300	636-DWKL130300	527€	Ø300	636-DWKL140300	356€	Ø300	636-DWKL150300	252€	Ø300	636-DWKL13C0300	629€	Ø300	636-DWKL14C0300	420€
Ø350	636-DWKL130350	661€	Ø350	636-DWKL140350	444€	Ø350	636-DWKL150350	341€	Ø350	636-DWKL13C0350	786€	Ø350	636-DWKL14C0350	527€
Ø400	636-DWKL130400	731€	Ø400	636-DWKL140400	521€	Ø400	636-DWKL150400	412€	Ø400	636-DWKL13C0400	872€	Ø400	636-DWKL14C0400	620€
Ø450	636-DWKL130450	802€	Ø450	636-DWKL140450	553€	Ø450	636-DWKL150450	454€	Ø450	636-DWKL13C0450	957€	Ø450	636-DWKL14C0450	658€
Ø500	636-DWKL130500	862€	Ø500	636-DWKL140500	567€	Ø500	636-DWKL150500	501€	Ø500	636-DWKL13C0500	1024€	Ø500	636-DWKL14C0500	670€
Ø550	636-DWKL130550	971€	Ø550	636-DWKL140550	729€	Ø550	636-DWKL150550	562€	Ø550	636-DWKL13C0550	1159€	Ø550	636-DWKL14C0550	869€
Ø600	636-DWKL130600	1123€	Ø600	636-DWKL140600	822€	Ø600	636-DWKL150600	665€	Ø600	636-DWKL13C0600	1339€	Ø600	636-DWKL14C0600	981€
Ø650	636-DWKL130650	1261€	Ø650	636-DWKL140650	923€	Ø650	636-DWKL150650	752€	Ø650	636-DWKL13C0650	1501€	Ø650	636-DWKL14C0650	1097€
Ø700	636-DWKL130700	1325€	Ø700	636-DWKL140700	967€	Ø700	636-DWKL150700	785€	Ø700	636-DWKL13C0700	1572€	Ø700	636-DWKL14C0700	1153€
Ø750	636-DWKL130750	1389€	Ø750	636-DWKL140750	1018€	Ø750	636-DWKL150750	825€	Ø750	636-DWKL13C0750	1654€	Ø750	636-DWKL14C0750	1205€
Ø800	636-DWKL130800	1541€	Ø800	636-DWKL140800	1127€	Ø800	636-DWKL150800	917€	Ø800	636-DWKL13C0800	1833€	Ø800	636-DWKL14C0800	1342€



Compensador de dilatación

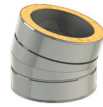

Codo 15°



Codo 30°

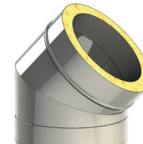

Codo 45°



Codo 60°

Ø80	636-DWKL510080	739€	Ø80	636-DWKL160080	133€	Ø80	636-DWKL170080	133€	Ø80	636-DWKL180080	133€	Ø80	636-DWKL840080	161€
Ø100	636-DWKL510100	768€	Ø100	636-DWKL160100	155€	Ø100	636-DWKL170100	155€	Ø100	636-DWKL180100	155€	Ø100	636-DWKL840100	186€
Ø130	636-DWKL510130	792€	Ø130	636-DWKL160130	157€	Ø130	636-DWKL170130	157€	Ø130	636-DWKL180130	157€	Ø130	636-DWKL840130	191€
Ø150	636-DWKL510150	909€	Ø150	636-DWKL160150	170€	Ø150	636-DWKL170150	170€	Ø150	636-DWKL180150	170€	Ø150	636-DWKL840150	206€
Ø180	636-DWKL510180	983€	Ø180	636-DWKL160180	186€	Ø180	636-DWKL170180	186€	Ø180	636-DWKL180180	186€	Ø180	636-DWKL840180	227€
Ø200	636-DWKL510200	1035€	Ø200	636-DWKL160200	211€	Ø200	636-DWKL170200	211€	Ø200	636-DWKL180200	211€	Ø200	636-DWKL840200	254€
Ø250	636-DWKL510250	1243€	Ø250	636-DWKL160250	275€	Ø250	636-DWKL170250	275€	Ø250	636-DWKL180250	275€	Ø250	636-DWKL840250	338€
Ø300	636-DWKL510300	1401€	Ø300	636-DWKL160300	334€	Ø300	636-DWKL170300	334€	Ø300	636-DWKL180300	334€	Ø300	636-DWKL840300	427€
Ø350	636-DWKL510350	1577€	Ø350	636-DWKL160350	452€	Ø350	636-DWKL170350	452€	Ø350	636-DWKL180350	452€	Ø350	636-DWKL840350	552€
Ø400	636-DWKL510400	1936€	Ø400	636-DWKL160400	565€	Ø400	636-DWKL170400	565€	Ø400	636-DWKL180400	565€			
Ø450	636-DWKL510450	2124€	Ø450	636-DWKL160450	823€	Ø450	636-DWKL170450	823€	Ø450	636-DWKL180450	823€			
Ø500	636-DWKL510500	2246€	Ø500	636-DWKL160500	922€	Ø500	636-DWKL170500	922€	Ø500	636-DWKL180500	922€			
Ø550	636-DWKL510550	2465€	Ø550	636-DWKL160550	1281€	Ø550	636-DWKL170550	1281€	Ø550	636-DWKL180550	1281€			
Ø600	636-DWKL510600	2674€	Ø600	636-DWKL160600	1558€	Ø600	636-DWKL170600	1558€	Ø600	636-DWKL180600	1558€			
Ø650	636-DWKL510650	2933€	Ø650	636-DWKL160650	1751€	Ø650	636-DWKL170650	1751€	Ø650	636-DWKL180650	1751€			
Ø700	636-DWKL510700	3418€	Ø700	636-DWKL160700	1836€	Ø700	636-DWKL170700	1836€	Ø700	636-DWKL180700	1836€			
Ø750	636-DWKL510750	4162€	Ø750	636-DWKL160750	1928€	Ø750	636-DWKL170750	1928€	Ø750	636-DWKL180750	1928€			
Ø800	636-DWKL510800	5153€	Ø800	636-DWKL160800	2140€	Ø800	636-DWKL170800	2140€	Ø800	636-DWKL180800	2140€			



# Sistema DW - KL 50 304

Ver instrucciones de corte página 207

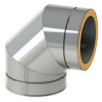

Codo 90°



Te 90°



Te 135°

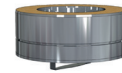

Colector de hollín aislado



Colector de hollín con desagüe aislado

Ø80	636-DWKL600080	186€	Ø80	636-DWKL3170080	283€	Ø80	636-DWKL120080	386€	Ø80	636-DWKL20330080	64€	Ø80	636-DWKL14600080	78€
Ø100	636-DWKL600100	220€	Ø100	636-DWKL3170100	333€	Ø100	636-DWKL120100	456€	Ø100	636-DWKL20330100	74€	Ø100	636-DWKL14600100	83€
Ø130	636-DWKL600130	228€	Ø130	636-DWKL3170130	348€	Ø130	636-DWKL120130	473€	Ø130	636-DWKL20330130	74€	Ø130	636-DWKL14600130	95€
Ø150	636-DWKL600150	245€	Ø150	636-DWKL3170150	363€	Ø150	636-DWKL120150	497€	Ø150	636-DWKL20330150	80€	Ø150	636-DWKL14600150	100€
Ø180	636-DWKL600180	268€	Ø180	636-DWKL3170180	396€	Ø180	636-DWKL120180	551€	Ø180	636-DWKL20330180	90€	Ø180	636-DWKL14600180	110€
Ø200	636-DWKL600200	304€	Ø200	636-DWKL3170200	458€	Ø200	636-DWKL120200	623€	Ø200	636-DWKL20330200	101€	Ø200	636-DWKL14600200	123€
Ø250	636-DWKL600250	408€	Ø250	636-DWKL3170250	614€	Ø250	636-DWKL120250	880€	Ø250	636-DWKL20330250	119€	Ø250	636-DWKL14600250	140€
Ø300	636-DWKL600300	520€	Ø300	636-DWKL3170300	791€	Ø300	636-DWKL120300	1129€	Ø300	636-DWKL20330300	140€	Ø300	636-DWKL14600300	166€
Ø350	636-DWKL600350	649€	Ø350	636-DWKL3170350	986€	Ø350	636-DWKL120350	1410€	Ø350	636-DWKL20330350	206€	Ø350	636-DWKL14600350	280€
			Ø400	636-DWKL3170400	1231€	Ø400	636-DWKL120400	1761€	Ø400	636-DWKL20330400	242€	Ø400	636-DWKL14600400	356€
			Ø450	636-DWKL3170450	1408€	Ø450	636-DWKL120450	2292€	Ø450	636-DWKL20330450	289€	Ø450	636-DWKL14600450	390€
			Ø500	636-DWKL3170500	1661€	Ø500	636-DWKL120500	2370€	Ø500	636-DWKL20330500	361€	Ø500	636-DWKL14600500	425€
			Ø550	636-DWKL3170550	1791€	Ø550	636-DWKL120550	2939€	Ø550	636-DWKL20330550	437€	Ø550	636-DWKL14600550	458€
			Ø600	636-DWKL3170600	2275€	Ø600	636-DWKL120600	3427€	Ø600	636-DWKL20330600	500€	Ø600	636-DWKL14600600	516€
			Ø650	636-DWKL3170650	2552€	Ø650	636-DWKL120650	3949€	Ø650	636-DWKL20330650	507€	Ø650	636-DWKL14600650	567€
			Ø700	636-DWKL3170700	2679€	Ø700	636-DWKL120700	4145€	Ø700	636-DWKL20330700	550€	Ø700	636-DWKL14600700	612€
			Ø750	636-DWKL3170750	2813€	Ø750	636-DWKL120750	4354€	Ø750	636-DWKL20330750	586€	Ø750	636-DWKL14600750	658€
			Ø800	636-DWKL3170800	319€	Ø800	636-DWKL120800	4832€	Ø800	636-DWKL20330800	622€	Ø800	636-DWKL14600800	699€



Codo 90° con inspección embreada



Módulo de inspección embreado



Módulo de medioambiente

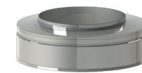

Terminal salida libre

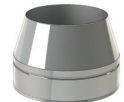

Terminal salida cónica

Ø80	636-DWKL19HT0080	452€	Ø150	636-DWKL10HT0150	488€	Ø130	636-DWKL12680130	746€	Ø80	636-DWKL320080	83€	Ø80	636-DWKL32C0080	98€
Ø100	636-DWKL19HT0100	458€	Ø180	636-DWKL10HT0180	530€	Ø150	636-DWKL12680150	770€	Ø100	636-DWKL320100	100€	Ø100	636-DWKL32C0100	110€
Ø130	636-DWKL19HT0130	478€	Ø200	636-DWKL10HT0200	618€	Ø180	636-DWKL12680180	799€	Ø130	636-DWKL320130	101€	Ø130	636-DWKL32C0130	109€
Ø150	636-DWKL19HT0150	534€	Ø250	636-DWKL10HT0250	653€	Ø200	636-DWKL12680200	828€	Ø150	636-DWKL320150	109€	Ø150	636-DWKL32C0150	123€
Ø180	636-DWKL19HT0180	622€	Ø300	636-DWKL10HT0300	840€	Ø250	636-DWKL12680250	922€	Ø180	636-DWKL320180	121€	Ø180	636-DWKL32C0180	140€
Ø200	636-DWKL19HT0200	716€	Ø350	636-DWKL10HT0350	1052€	Ø300	636-DWKL12680300	1012€	Ø200	636-DWKL320200	140€	Ø200	636-DWKL32C0200	157€
Ø250	636-DWKL19HT0250	829€	Ø400	636-DWKL10HT0400	1309€	Ø350	636-DWKL12680350	1579€	Ø250	636-DWKL320250	184€	Ø250	636-DWKL32C0250	218€
Ø300	636-DWKL19HT0300	1067€	Ø450	636-DWKL10HT0450	1437€	Ø400	636-DWKL12680400	1687€	Ø300	636-DWKL320300	235€	Ø300	636-DWKL32C0300	274€
Ø350	636-DWKL19HT0350	1336€	Ø500	636-DWKL10HT0500	1698€	Ø450	636-DWKL12680450	1790€	Ø350	636-DWKL320350	290€	Ø350	636-DWKL32C0350	337€
			Ø550	636-DWKL10HT0550	1828€	Ø500	636-DWKL12680500	1878€	Ø400	636-DWKL320400	363€	Ø400	636-DWKL32C0400	427€
			Ø600	636-DWKL10HT0600	2322€	Ø550	636-DWKL12680550	2047€	Ø450	636-DWKL320450	397€	Ø450	636-DWKL32C0450	483€
			Ø650	636-DWKL10HT0650	2497€	Ø600	636-DWKL12680600	2217€	Ø500	636-DWKL320500	437€	Ø500	636-DWKL32C0500	510€
			Ø700	636-DWKL10HT0700	2622€	Ø650	636-DWKL12680650	2338€	Ø550	636-DWKL320550	456€	Ø550	636-DWKL32C0550	538€
			Ø750	636-DWKL10HT0750	2656€	Ø700	636-DWKL12680700	2512€	Ø600	636-DWKL320600	483€	Ø600	636-DWKL32C0600	562€
			Ø800	636-DWKL10HT0800	3534€	Ø750	636-DWKL12680750	2673€	Ø650	636-DWKL320650	544€	Ø650	636-DWKL32C0650	571€
						Ø800	636-DWKL12680800	2853€	Ø700	636-DWKL320700	568€	Ø700	636-DWKL32C0700	599€
									Ø750	636-DWKL320750	599€	Ø750	636-DWKL32C0750	631€
									Ø800	636-DWKL320800	665€	Ø800	636-DWKL32C0800	706€

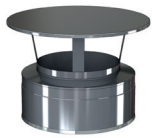

Terminal anti-lluvia



Terminal horizontal con rejilla



Terminal cónico alta Temperatura



Terminal JET (Alta Temperatura)

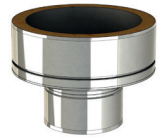

Adaptador caldera hembra (mismo diámetro)

Ø80	636-DWKL5260080	119€	Ø80	636-DWKL5320080	95€	Ø80	636-DWKL32HT0080	109€	Ø80	636-DWKL34HT0080	1127€	Ø80	636-DWKL37H0080	65€
Ø100	636-DWKL5260100	140€	Ø100	636-DWKL5320100	98€	Ø100	636-DWKL32HT0100	132€	Ø100	636-DWKL34HT0100	1169€	Ø100	636-DWKL37H0100	78€
Ø130	636-DWKL5260130	141€	Ø130	636-DWKL5320130	99€	Ø130	636-DWKL32HT0130	133€	Ø130	636-DWKL34HT0130	1263€	Ø130	636-DWKL37H0130	78€
Ø150	636-DWKL5260150	141€	Ø150	636-DWKL5320150	109€	Ø150	636-DWKL32HT0150	145€	Ø150	636-DWKL34HT0150	1315€	Ø150	636-DWKL37H0150	78€
Ø180	636-DWKL5260180	168€	Ø180	636-DWKL5320180	132€	Ø180	636-DWKL32HT0180	155€	Ø180	636-DWKL34HT0180	1478€	Ø180	636-DWKL37H0180	96€
Ø200	636-DWKL5260200	187€	Ø200	636-DWKL5320200	150€	Ø200	636-DWKL32HT0200	180€	Ø200	636-DWKL34HT0200	1629€	Ø200	636-DWKL37H0200	101€
Ø250	636-DWKL5260250	255€	Ø250	636-DWKL5320250	183€	Ø250	636-DWKL32HT0250	235€	Ø250	636-DWKL34HT0250	2076€	Ø250	636-DWKL37H0250	140€
Ø300	636-DWKL5260300	327€	Ø300	636-DWKL5320300	227€	Ø300	636-DWKL32HT0300	298€	Ø300	636-DWKL34HT0300	2376€	Ø300	636-DWKL37H0300	180€
Ø350	636-DWKL5260350	406€	Ø350	636-DWKL5320350	305€	Ø350	636-DWKL32HT0350	368€	Ø350	636-DWKL34HT0350	2756€	Ø350	636-DWKL37H0350	220€
Ø400	636-DWKL5260400	505€	Ø400	636-DWKL5320400	358€	Ø400	636-DWKL32HT0400	468€	Ø400	636-DWKL34HT0400	3102€	Ø400	636-DWKL37H0400	272€
			Ø450	636-DWKL5320450	534€	Ø450	636-DWKL32HT0450	510€	Ø450	636-DWKL34HT0450	3522€	Ø450	636-DWKL37H0450	297€
			Ø500	636-DWKL5320500	557€	Ø500	636-DWKL32HT0500	560€	Ø500	636-DWKL34HT0500	3812€	Ø500	636-DWKL37H0500	327€
			Ø550	636-DWKL5320550	799€	Ø550	636-DWKL32HT0550	587€	Ø550	636-DWKL34HT0550	4693€	Ø550	636-DWKL37H0550	401€
			Ø600	636-DWKL5320600	900€	Ø600	636-DWKL32HT0600	622€	Ø600	636-DWKL34HT0600	5453€	Ø600	636-DWKL37H0600	427€
			Ø650	636-DWKL5320650	990€	Ø650	636-DWKL32HT0650	701€	Ø650	636-DWKL34HT0650	5801€	Ø650	636-DWKL37H0650	478€
			Ø700	636-DWKL5320700	1070€	Ø700	636-DWKL32HT0700	731€	Ø700	636-DWKL34HT0700	6175€	Ø700	636-DWKL37H0700	505€
			Ø750	636-DWKL5320750	1142€	Ø750	636-DWKL32HT0750	770€	Ø750	636-DWKL34HT0750	6892€	Ø750	636-DWKL37H0750	530€
			Ø800	636-DWKL5320800	1218€	Ø800	636-DWKL32HT0800	858€	Ø800	636-DWKL34HT0800	7356€	Ø800	636-DWKL37H0800	590€

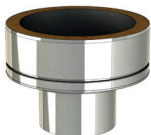

Adaptador caldera macho (mismo diámetro)

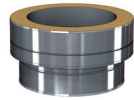

Ampliación (1 diámetro)

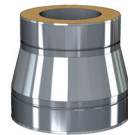

Reducción (1 diámetro)

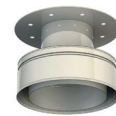

Adaptador embreado entrada

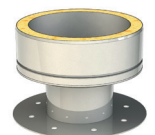

Adaptador embreado salida

Ø80	636-DWKL37M0080	65€	Ø100	636-DWKL9830100	141€	Ø80	636-DWKL9820080	110€	Ø80	636-DWKL9710080	129€	Ø80	636-DWKL8560080	129€
Ø100	636-DWKL37M0100	78€	Ø130	636-DWKL9830130	157€	Ø100	636-DWKL9820100	141€	Ø100	636-DWKL9710100	152€	Ø100	636-DWKL8560100	152€
Ø130	636-DWKL37M0130	78€	Ø150	636-DWKL9830150	185€	Ø130	636-DWKL9820130	157€	Ø130	636-DWKL9710130	155€	Ø130	636-DWKL8560130	155€
Ø150	636-DWKL37M0150	78€	Ø180	636-DWKL9830180	227€	Ø150	636-DWKL9820150	185€	Ø150	636-DWKL9710150	177€	Ø150	636-DWKL8560150	177€
Ø180	636-DWKL37M0180	96€	Ø200	636-DWKL9830200	275€	Ø180	636-DWKL9820180	227€	Ø180	636-DWKL9710180	206€	Ø180	636-DWKL8560180	206€
Ø200	636-DWKL37M0200	101€	Ø250	636-DWKL9830250	389€	Ø200	636-DWKL9820200	275€	Ø200	636-DWKL9710200	235€	Ø200	636-DWKL8560200	235€
Ø250	636-DWKL37M0250	140€	Ø300	636-DWKL9830300	444€	Ø250	636-DWKL9820250	389€	Ø250	636-DWKL9710250	317€	Ø250	636-DWKL8560250	317€
Ø300	636-DWKL37M0300	180€	Ø350	636-DWKL9830350	527€	Ø300	636-DWKL9820300	444€	Ø300	636-DWKL9710300	397€	Ø300	636-DWKL8560300	397€
Ø350	636-DWKL37M0350	220€	Ø400	636-DWKL9830400	647€	Ø350	636-DWKL9820350	527€	Ø350	636-DWKL9710350	496€	Ø350	636-DWKL8560350	496€
Ø400	636-DWKL37M0400	272€	Ø450	636-DWKL9830450	887€	Ø400	636-DWKL9820400	647€	Ø400	636-DWKL9710400	603€	Ø400	636-DWKL8560400	603€
Ø450	636-DWKL37M0450	297€	Ø500	636-DWKL9830500	1012€	Ø450	636-DWKL9820450	887€	Ø450	636-DWKL9710450	695€	Ø450	636-DWKL8560450	695€
Ø500	636-DWKL37M0500	327€	Ø550	636-DWKL9830550	1058€	Ø500	636-DWKL9820500	1012€	Ø500	636-DWKL9710500	789€	Ø500	636-DWKL8560500	789€
Ø550	636-DWKL37M0550	401€	Ø600	636-DWKL9830600	1336€	Ø550	636-DWKL9820550	1058€	Ø550	636-DWKL9710550	869€	Ø550	636-DWKL8560550	869€
Ø600	636-DWKL37M0600	427€	Ø650	636-DWKL9830650	1496€	Ø600	636-DWKL9820600	1336€	Ø600	636-DWKL9710600	964€	Ø600	636-DWKL8560600	964€
Ø650	636-DWKL37M0650	478€	Ø700	636-DWKL9830700	1572€	Ø650	636-DWKL9820650	1496€	Ø650	636-DWKL9710650	1082€	Ø650	636-DWKL8560650	1082€
Ø700	636-DWKL37M0700	505€	Ø750	636-DWKL9830750	1649€	Ø700	636-DWKL9820700	1572€	Ø700	636-DWKL9710700	1135€	Ø700	636-DWKL8560700	1135€
Ø750	636-DWKL37M0750	530€	Ø800	636-DWKL9830800	1830€	Ø750	636-DWKL9820750	1649€	Ø750	636-DWKL9710750	1192€	Ø750	636-DWKL8560750	1192€
Ø800	636-DWKL37M0800	590€							Ø800	636-DWKL9710800	1325€	Ø800	636-DWKL8560800	1325€

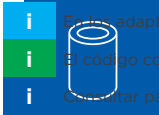

En los adaptadores embreados se deben indicar las medidas de la brida.

El código corresponde al diámetro de la silleta de la placa, el mayor en la ampliación y el menor en la reducción)

Consultar página 91 para ver distancias de separación.

## Sistema DW KL 50.304



Adaptador para soldar  
(mismo diámetro)



Placa tope

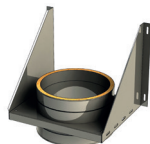

Soporte de carga regulable

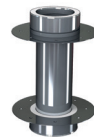

Pasamuros EI



Abrazadera de unión 2.0

Ø150	636-DWKL20490150	95€	Ø80	636-DWKL14650080	169€	Ø80	636-DWKL3790080	204€	Ø80	636-DWKL43300080	593€	Ø80	665-ZUWA9890180	14.65€
Ø180	636-DWKL20490180	112€	Ø100	636-DWKL14650100	178€	Ø100	636-DWKL3790100	205€	Ø100	636-DWKL43300100	652€	Ø100	665-ZUWA9890200	17.9€
Ø200	636-DWKL20490200	117€	Ø130	636-DWKL14650130	186€	Ø130	636-DWKL3790130	211€	Ø130	636-DWKL43300130	682€	Ø130	665-ZUWA9890230	19.51€
Ø250	636-DWKL20490250	145€	Ø150	636-DWKL14650150	210€	Ø150	636-DWKL3790150	235€	Ø150	636-DWKL43300150	628€	Ø150	665-ZUWA9890250	26.04€
Ø300	636-DWKL20490300	166€	Ø180	636-DWKL14650180	251€	Ø180	636-DWKL3790180	280€	Ø180	636-DWKL43300180	701€	Ø180	665-ZUWA9890280	29.27€
Ø350	636-DWKL20490350	191€	Ø200	636-DWKL14650200	283€	Ø200	636-DWKL3790200	321€	Ø200	636-DWKL43300200	789€	Ø200	665-ZUWA9890300	30.9€
Ø400	636-DWKL20490400	242€	Ø250	636-DWKL14650250	344€	Ø250	636-DWKL3790250	390€	Ø250	636-DWKL43300250	1003€	Ø250	665-ZUWA9890350	34.15€
Ø450	636-DWKL20490450	264€	Ø300	636-DWKL14650300	453€	Ø300	636-DWKL3790300	502€	Ø300	636-DWKL43300300	1143€	Ø300	665-ZUWA9890400	42.42€
Ø500	636-DWKL20490500	286€	Ø350	636-DWKL14650350	557€	Ø350	636-DWKL3790350	622€	Ø350	636-DWKL43300350	1316€	Ø350	665-ZUWA9890450	48.72€
Ø550	636-DWKL20490550	367€	Ø400	636-DWKL14650400	702€	Ø400	636-DWKL3790400	773€	Ø400	636-DWKL43300400	1517€	Ø400	665-ZUWA9890500	54€
Ø600	636-DWKL20490600	454€	Ø450	636-DWKL14650450	770€	Ø450	636-DWKL3790450	852€	Ø450	636-DWKL43300450	1771€	Ø450	665-ZUWA9890550	58€
Ø650	636-DWKL20490650	500€	Ø500	636-DWKL14650500	833€	Ø500	636-DWKL3790500	932€	Ø500	636-DWKL43300500	1989€	Ø500	665-ZUWA9890600	66€
Ø700	636-DWKL20490700	522€	Ø550	636-DWKL14650550	996€	Ø550	636-DWKL3790550	1083€	Ø550	636-DWKL43300550	2121€	Ø550	665-ZUWA9890650	73€
Ø750	636-DWKL20490750	552€	Ø600	636-DWKL14650600	1111€	Ø600	636-DWKL3790600	1218€	Ø600	636-DWKL43300600	2192€	Ø600	665-ZUWA9890700	84€
Ø800	636-DWKL20490800	611€	Ø650	636-DWKL14650650	1246€	Ø650	636-DWKL3790650	1367€	Ø650	636-DWKL43300650	2101€	Ø650	665-ZUWA9890750	100€
			Ø700	636-DWKL14650700	1308€	Ø700	636-DWKL3790700	1434€	Ø700	636-DWKL43300700	2338€	Ø700	665-ZUWA9890800	111€
			Ø750	636-DWKL14650750	1372€	Ø750	636-DWKL3790750	1506€	Ø750	636-DWKL43300750	2498€	Ø750	665-ZUWA9890850	119€
			Ø800	636-DWKL14650800	1523€	Ø800	636-DWKL3790800	1674€	Ø800	636-DWKL43300800	2607€	Ø800	665-ZUWA9890900	129€



Abrazadera fijación pared  
regulable 50-80mm



Abrazadera fijación pared  
fija



Base de abrazadera  
distanciadora



Alas distanciadoras A



Alas distanciadoras B

Ø80	665-ZUWA5560180	39.04€	Ø400	665-ZUWA556F0500	123€	Ø80	665-ZUWA14620180	52€	Ø80	665-ZUWA1462A	47.13€	Ø80	665-ZUWA1462B	65€
Ø100	665-ZUWA5560200	45.58€	Ø450	665-ZUWA556F0550	155€	Ø100	665-ZUWA14620200	58€	Ø100	665-ZUWA1462A	47.13€	Ø100	665-ZUWA1462B	65€
Ø130	665-ZUWA5560230	52€	Ø500	665-ZUWA556F0600	185€	Ø130	665-ZUWA14620230	77€	Ø130	665-ZUWA1462A	47.13€	Ø130	665-ZUWA1462B	65€
Ø150	665-ZUWA5560250	61€	Ø550	665-ZUWA556F0650	203€	Ø150	665-ZUWA14620250	100€	Ø150	665-ZUWA1462A	47.13€	Ø150	665-ZUWA1462B	65€
Ø180	665-ZUWA5560280	64€	Ø600	665-ZUWA556F0700	264€	Ø180	665-ZUWA14620280	123€	Ø180	665-ZUWA1462A	47.13€	Ø180	665-ZUWA1462B	65€
Ø200	665-ZUWA5560300	64€	Ø650	665-ZUWA556F0750	321€	Ø200	665-ZUWA14620300	138€	Ø200	665-ZUWA1462A	47.13€	Ø200	665-ZUWA1462B	65€
Ø250	665-ZUWA5560350	67€	Ø700	665-ZUWA556F0800	358€	Ø250	665-ZUWA14620350	185€	Ø250	665-ZUWA1462A	47.13€	Ø250	665-ZUWA1462B	65€
Ø300	665-ZUWA5560400	88€	Ø750	665-ZUWA556F0850	379€	Ø300	665-ZUWA14620400	241€	Ø300	665-ZUWA1462A	47.13€	Ø300	665-ZUWA1462B	65€
Ø350	665-ZUWA5560450	98€	Ø800	665-ZUWA556F0900	404€	Ø350	665-ZUWA14620450	298€	Ø350	665-ZUWA1462A	47.13€	Ø350	665-ZUWA1462B	65€
						Ø400	665-ZUWA14620500	328€	Ø400	665-ZUWA1462A	47.13€	Ø400	665-ZUWA1462B	65€
						Ø450	665-ZUWA14620550	365€	Ø450	665-ZUWA1462A	47.13€	Ø450	665-ZUWA1462B	65€
						Ø500	665-ZUWA14620600	412€	Ø500	665-ZUWA1462A	47.13€	Ø500	665-ZUWA1462B	65€
						Ø550	665-ZUWA14620650	444€	Ø550	665-ZUWA1462A	47.13€	Ø550	665-ZUWA1462B	65€
						Ø600	665-ZUWA14620700	572€	Ø600	665-ZUWA1462A	47.13€	Ø600	665-ZUWA1462B	65€
						Ø650	665-ZUWA14620750	587€	Ø650	665-ZUWA1462A	47.13€	Ø650	665-ZUWA1462B	65€
						Ø700	665-ZUWA14620800	786€	Ø700	665-ZUWA1462A	47.13€	Ø700	665-ZUWA1462B	65€
						Ø750	665-ZUWA14620850	837€	Ø750	665-ZUWA1462A	47.13€	Ø750	665-ZUWA1462B	65€
						Ø800	665-ZUWA14620900	886€	Ø800	665-ZUWA1462A	47.13€	Ø800	665-ZUWA1462B	65€



Alas distanciadoras C



Alas distanciadoras D

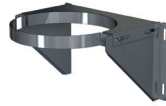

Abrazadera de soporte



Abrazadera con doble pértiga telescópica L=2000mm



Abrazadera forjado inox

Ø80	665-ZUWA1462C	81€	Ø80	665-ZUWA1462D	104€	Ø80	665-ZUWA8580180	145€	Ø80	665-ZUWA1910180	156€	Ø80	665-ZUWA620180	42.42€
Ø100	665-ZUWA1462C	81€	Ø100	665-ZUWA1462D	104€	Ø100	665-ZUWA8580200	145€	Ø100	665-ZUWA1910200	173€	Ø100	665-ZUWA620200	47.13€
Ø130	665-ZUWA1462C	81€	Ø130	665-ZUWA1462D	104€	Ø130	665-ZUWA8580230	163€	Ø130	665-ZUWA1910230	179€	Ø130	665-ZUWA620230	50€
Ø150	665-ZUWA1462C	81€	Ø150	665-ZUWA1462D	104€	Ø150	665-ZUWA8580250	185€	Ø150	665-ZUWA1910250	196€	Ø150	665-ZUWA620250	50€
Ø180	665-ZUWA1462C	81€	Ø180	665-ZUWA1462D	104€	Ø180	665-ZUWA8580280	202€	Ø180	665-ZUWA1910280	233€	Ø180	665-ZUWA620280	59€
Ø200	665-ZUWA1462C	81€	Ø200	665-ZUWA1462D	104€	Ø200	665-ZUWA8580300	203€	Ø200	665-ZUWA1910300	233€	Ø200	665-ZUWA620300	59€
Ø250	665-ZUWA1462C	81€	Ø250	665-ZUWA1462D	104€	Ø250	665-ZUWA8580350	221€	Ø250	665-ZUWA1910350	249€	Ø250	665-ZUWA620350	66€
Ø300	665-ZUWA1462C	81€	Ø300	665-ZUWA1462D	104€	Ø300	665-ZUWA8580400	270€	Ø300	665-ZUWA1910400	272€	Ø300	665-ZUWA620400	74€
Ø350	665-ZUWA1462C	81€	Ø350	665-ZUWA1462D	104€	Ø350	665-ZUWA8580450	321€	Ø350	665-ZUWA1910450	380€	Ø350	665-ZUWA620450	83€
Ø400	665-ZUWA1462C	81€	Ø400	665-ZUWA1462D	104€	Ø400	665-ZUWA8580500	354€	Ø400	665-ZUWA1910500	496€	Ø400	665-ZUWA620500	96€
Ø450	665-ZUWA1462C	81€	Ø450	665-ZUWA1462D	104€	Ø450	665-ZUWA8580550	401€	Ø450	665-ZUWA1910550	647€	Ø450	665-ZUWA620550	103€
Ø500	665-ZUWA1462C	81€	Ø500	665-ZUWA1462D	104€	Ø500	665-ZUWA8580600	454€	Ø500	665-ZUWA1910600	699€	Ø500	665-ZUWA620600	109€
Ø550	665-ZUWA1462C	81€	Ø550	665-ZUWA1462D	104€	Ø550	665-ZUWA8580650	492€	Ø550	665-ZUWA1910650	766€	Ø550	665-ZUWA620650	115€
Ø600	665-ZUWA1462C	81€	Ø600	665-ZUWA1462D	104€	Ø600	665-ZUWA8580700	637€	Ø600	665-ZUWA1910700	871€	Ø600	665-ZUWA620700	122€
Ø650	665-ZUWA1462C	81€	Ø650	665-ZUWA1462D	104€	Ø650	665-ZUWA8580750	780€	Ø650	665-ZUWA1910750	976€	Ø650	665-ZUWA620750	130€
Ø700	665-ZUWA1462C	81€	Ø700	665-ZUWA1462D	104€	Ø700	665-ZUWA8580800	870€	Ø700	665-ZUWA1910800	1127€	Ø700	665-ZUWA620800	136€
Ø750	665-ZUWA1462C	81€	Ø750	665-ZUWA1462D	104€	Ø750	665-ZUWA8580850	929€	Ø750	665-ZUWA1910850	1199€			
Ø800	665-ZUWA1462C	81€	Ø800	665-ZUWA1462D	104€	Ø800	665-ZUWA8580900	984€	Ø800	665-ZUWA1910900	1267€			



Abrazadera para amarre por tornillo



Abrazadera vientos



Gancho y pletina para módulo de medioambiente



Soporte de techo



Collarín antitormenta

Ø80	665-ZUWA10630180	39.04€	Ø80	665-ZUWA420180	21.16€	Ø80	665-ZUWA43940180	155€	Ø80	665-ZUWA9360180	50€	Ø80	665-ZUWA3070180	40.87€
Ø100	665-ZUWA10630200	42.42€	Ø100	665-ZUWA420200	26.04€	Ø100	665-ZUWA43940200	161€	Ø100	665-ZUWA9360200	56€	Ø100	665-ZUWA3070200	47.13€
Ø130	665-ZUWA10630230	50€	Ø130	665-ZUWA420230	27.67€	Ø130	665-ZUWA43940230	178€	Ø130	665-ZUWA9360230	65€	Ø130	665-ZUWA3070230	52€
Ø150	665-ZUWA10630250	50€	Ø150	665-ZUWA420250	29.27€	Ø150	665-ZUWA43940250	178€	Ø150	665-ZUWA9360250	73€	Ø150	665-ZUWA3070250	59€
Ø180	665-ZUWA10630280	58€	Ø180	665-ZUWA420280	32.52€	Ø180	665-ZUWA43940280	188€	Ø180	665-ZUWA9360280	83€	Ø180	665-ZUWA3070280	71€
Ø200	665-ZUWA10630300	65€	Ø200	665-ZUWA420300	34.15€	Ø200	665-ZUWA43940300	206€	Ø200	665-ZUWA9360300	84€	Ø200	665-ZUWA3070300	71€
Ø250	665-ZUWA10630350	74€	Ø250	665-ZUWA420350	37.43€	Ø250	665-ZUWA43940350	226€	Ø250	665-ZUWA9360350	95€	Ø250	665-ZUWA3070350	77€
Ø300	665-ZUWA10630400	84€	Ø300	665-ZUWA420400	40.87€	Ø300	665-ZUWA43940400	321€	Ø300	665-ZUWA9360400	104€	Ø300	665-ZUWA3070400	83€
Ø350	665-ZUWA10630450	97€	Ø350	665-ZUWA420450	56€	Ø350	665-ZUWA43940450	343€	Ø350	665-ZUWA9360450	144€	Ø350	665-ZUWA3070450	114€
Ø400	665-ZUWA10630500	106€	Ø400	665-ZUWA420500	74€	Ø400	665-ZUWA43940500	364€	Ø400	665-ZUWA9360500	186€	Ø400	665-ZUWA3070500	151€
Ø450	665-ZUWA10630550	114€	Ø450	665-ZUWA420550	98€	Ø450	665-ZUWA43940550	386€	Ø450	665-ZUWA9360550	241€	Ø450	665-ZUWA3070550	199€
Ø500	665-ZUWA10630600	129€	Ø500	665-ZUWA420600	106€	Ø500	665-ZUWA43940600	406€	Ø500	665-ZUWA9360600	264€	Ø500	665-ZUWA3070600	211€
Ø550	665-ZUWA10630650	139€	Ø550	665-ZUWA420650	114€	Ø550	665-ZUWA43940650	428€	Ø550	665-ZUWA9360650	286€	Ø550	665-ZUWA3070650	234€
Ø600	665-ZUWA10630700	151€	Ø600	665-ZUWA420700	151€	Ø600	665-ZUWA43940700	454€	Ø600	665-ZUWA9360700	329€	Ø600	665-ZUWA3070700	268€
Ø650	665-ZUWA10630750	168€	Ø650	665-ZUWA420750	185€	Ø650	665-ZUWA43940750	486€	Ø650	665-ZUWA9360750	367€	Ø650	665-ZUWA3070750	296€
Ø700	665-ZUWA10630800	179€	Ø700	665-ZUWA420800	204€	Ø700	665-ZUWA43940800	505€	Ø700	665-ZUWA9360800	421€	Ø700	665-ZUWA3070800	343€
Ø750	665-ZUWA10630850	188€	Ø750	665-ZUWA420850	218€	Ø750	665-ZUWA43940850	533€	Ø750	665-ZUWA9360850	450€	Ø750	665-ZUWA3070850	365€
Ø800	665-ZUWA10630900	202€	Ø800	665-ZUWA420900	232€	Ø800	665-ZUWA43940900	553€	Ø800	665-ZUWA9360900	474€	Ø800	665-ZUWA3070900	387€



# Sistema DW - KL 50 304

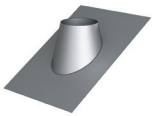

Cubreaguas 25°-45° aluminio

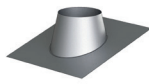

Cubreaguas 5°-25° aluminio

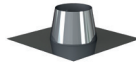

Cubreaguas plano inox

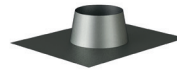

Cubreaguas plomo 0°-5°

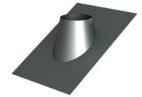

Cubreaguas plomo 25°-45°

Ø80	665-ZUWA939AL0180	250€	Ø80	665-ZUWA938AL0180	235€	Ø80	665-ZUWA11280180	170€	Ø80	665-ZUWA9370180	234€	Ø80	665-ZUWA9390180	379€
Ø100	665-ZUWA939AL0200	269€	Ø100	665-ZUWA938AL0200	252€	Ø100	665-ZUWA11280200	185€	Ø100	665-ZUWA9370200	260€	Ø100	665-ZUWA9390200	386€
Ø130	665-ZUWA939AL0230	288€	Ø130	665-ZUWA938AL0230	261€	Ø130	665-ZUWA11280230	191€	Ø130	665-ZUWA9370230	269€	Ø130	665-ZUWA9390230	397€
Ø150	665-ZUWA939AL0250	305€	Ø150	665-ZUWA938AL0250	282€	Ø150	665-ZUWA11280250	211€	Ø150	665-ZUWA9370250	294€	Ø150	665-ZUWA9390250	401€
Ø180	665-ZUWA939AL0280	332€	Ø180	665-ZUWA938AL0280	282€	Ø180	665-ZUWA11280280	227€	Ø180	665-ZUWA9370280	316€	Ø180	665-ZUWA9390280	413€
Ø200	665-ZUWA939AL0300	332€	Ø200	665-ZUWA938AL0300	317€	Ø200	665-ZUWA11280300	233€	Ø200	665-ZUWA9370300	323€	Ø200	665-ZUWA9390300	417€
Ø250	665-ZUWA939AL0350	387€	Ø250	665-ZUWA938AL0350	351€	Ø250	665-ZUWA11280350	260€	Ø250	665-ZUWA9370350	361€	Ø250	665-ZUWA9390350	431€
Ø300	665-ZUWA939AL0400	433€	Ø300	665-ZUWA938AL0400	390€	Ø300	665-ZUWA11280400	286€	Ø300	665-ZUWA9370400	396€	Ø300	665-ZUWA9390400	454€
Ø350	665-ZUWA939AL0450	492€	Ø350	665-ZUWA938AL0450	436€	Ø350	665-ZUWA11280450	306€	Ø350	665-ZUWA9370450	428€	Ø350	665-ZUWA9390450	541€
Ø400	665-ZUWA939AL0500	549€	Ø400	665-ZUWA938AL0500	488€	Ø400	665-ZUWA11280500	352€	Ø400	665-ZUWA9370500	488€	Ø400	665-ZUWA9390500	618€
Ø450	665-ZUWA939AL0550	607€	Ø450	665-ZUWA938AL0550	524€	Ø450	665-ZUWA11280550	389€	Ø450	665-ZUWA9370550	539€	Ø450	665-ZUWA9390550	691€
Ø500	665-ZUWA939AL0600	661€	Ø500	665-ZUWA938AL0600	573€	Ø500	665-ZUWA11280600	437€	Ø500	665-ZUWA9370600	606€	Ø500	665-ZUWA9390600	775€
Ø550	665-ZUWA939AL0650	730€	Ø550	665-ZUWA938AL0650	618€	Ø550	665-ZUWA11280650	492€	Ø550	665-ZUWA9370650	684€	Ø550	665-ZUWA9390650	869€
Ø600	665-ZUWA939AL0700	840€	Ø600	665-ZUWA938AL0700	679€	Ø600	665-ZUWA11280700	551€	Ø600	665-ZUWA9370700	763€	Ø600	665-ZUWA9390700	971€
Ø650	665-ZUWA939AL0750	939€	Ø650	665-ZUWA938AL0750	736€	Ø650	665-ZUWA11280750	587€	Ø650	665-ZUWA9370750	815€	Ø650	665-ZUWA9390750	1034€
Ø700	665-ZUWA939AL0800	1123€	Ø700	665-ZUWA938AL0800	880€	Ø700	665-ZUWA11280800	614€	Ø700	665-ZUWA9370800	850€	Ø700	665-ZUWA9390800	1082€
Ø750	665-ZUWA939AL0850	1271€	Ø750	665-ZUWA938AL0850	1015€	Ø750	665-ZUWA11280850	652€	Ø750	665-ZUWA9370850	902€	Ø750	665-ZUWA9390850	1151€
Ø800	665-ZUWA939AL0900	1348€	Ø800	665-ZUWA938AL0900	1100€	Ø800	665-ZUWA11280900	688€	Ø800	665-ZUWA9370900	955€	Ø800	665-ZUWA9390900	1215€

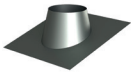

Cubreaguas plomo 5°-25°



Pasamuros



Pasta KL



Disco madera KL agujero Ø12 a 5cm del borde

Ø80	665-ZUWA9380180	234€	Ø80	665-ZUWA9870180	52€	Ø80	KL PASTE	49.71€	Ø80	665-ZUWA20350080	#N/A€
Ø100	665-ZUWA9380200	260€	Ø100	665-ZUWA9870200	52€	Ø100	KL PASTE	49.71€	Ø100	665-ZUWA20350100	90€
Ø130	665-ZUWA9380230	269€	Ø130	665-ZUWA9870230	64€	Ø130	KL PASTE	49.71€	Ø130	665-ZUWA20350130	#N/A€
Ø150	665-ZUWA9380250	294€	Ø150	665-ZUWA9870250	65€	Ø150	KL PASTE	49.71€	Ø150	665-ZUWA20350150	#N/A€
Ø180	665-ZUWA9380280	316€	Ø180	665-ZUWA9870280	81€	Ø180	KL PASTE	49.71€	Ø180	665-ZUWA20350180	#N/A€
Ø200	665-ZUWA9380300	323€	Ø200	665-ZUWA9870300	83€	Ø200	KL PASTE	49.71€	Ø200	665-ZUWA20350200	98€
Ø250	665-ZUWA9380350	361€	Ø250	665-ZUWA9870350	95€	Ø250	KL PASTE	49.71€	Ø250	665-ZUWA20350250	#N/A€
Ø300	665-ZUWA9380400	396€	Ø300	665-ZUWA9870400	121€	Ø300	KL PASTE	49.71€	Ø300	665-ZUWA20350300	#N/A€
Ø350	665-ZUWA9380450	428€	Ø350	665-ZUWA9870450	156€	Ø350	KL PASTE	49.71€	Ø350	665-ZUWA20350350	160€
Ø400	665-ZUWA9380500	488€	Ø400	665-ZUWA9870500	204€	Ø400	KL PASTE	49.71€	Ø400	665-ZUWA20350400	#N/A€
Ø450	665-ZUWA9380550	539€	Ø450	665-ZUWA9870550	221€	Ø450	KL PASTE	49.71€	Ø450	665-ZUWA20350450	160€
Ø500	665-ZUWA9380600	606€	Ø500	665-ZUWA9870600	244€	Ø500	KL PASTE	49.71€	Ø500	665-ZUWA20350500	241€
Ø550	665-ZUWA9380650	684€	Ø550	665-ZUWA9870650	271€	Ø550	KL PASTE	49.71€	Ø550	665-ZUWA20350550	241€
Ø600	665-ZUWA9380700	763€	Ø600	665-ZUWA9870700	337€	Ø600	KL PASTE	49.71€	Ø600	665-ZUWA20350600	408€
Ø650	665-ZUWA9380750	815€	Ø650	665-ZUWA9870750	398€	Ø650	KL PASTE	49.71€	Ø650	665-ZUWA20350650	408€
Ø700	665-ZUWA9380800	850€	Ø700	665-ZUWA9870800	466€	Ø700	KL PASTE	49.71€	Ø700	665-ZUWA20350700	408€
Ø750	665-ZUWA9380850	902€	Ø750	665-ZUWA9870850	497€	Ø750	KL PASTE	49.71€	Ø750	665-ZUWA20350750	496€
Ø800	665-ZUWA9380900	955€	Ø800	665-ZUWA9870900	527€	Ø800	KL PASTE	49.71€	Ø800	665-ZUWA20350800	496€



Clapeta motorizada 20Nm,  
20s

Ø150	MAK-HTSF150	3293€
Ø200	MAK-HTSF200	4108€
Ø250	MAK-HTSF250	4387€
Ø300	MAK-HTSF300	4666€
Ø350	MAK-HTSF350	5517€
Ø400	MAK-HTSF400	6374€
Ø450	MAK-HTSF450	7222€
Ø500	MAK-HTSF500	8071€
Ø550	MAK-HTSF550	8795€
Ø600	MAK-HTSF600	9517€
Ø650	MAK-HTSF650	10238€
Ø700	MAK-HTSF700	10959€
Ø750	MAK-HTSF750	11679€
Ø800	MAK-HTSF800	12404€

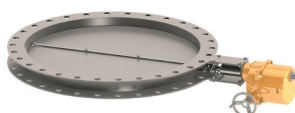

Clapeta motorizada 90Nm,  
17s

Ø150	MAK-HTSY150	7140€
Ø200	MAK-HTSY200	7421€
Ø250	MAK-HTSY250	7702€
Ø300	MAK-HTSY300	7980€
Ø350	MAK-HTSY350	8834€
Ø400	MAK-HTSY400	9686€
Ø450	MAK-HTSY450	10538€
Ø500	MAK-HTSY500	11388€
Ø550	MAK-HTSY550	12110€
Ø600	MAK-HTSY600	12830€
Ø650	MAK-HTSY650	13555€
Ø700	MAK-HTSY700	14275€
Ø750	MAK-HTSY750	14997€
Ø800	MAK-HTSY800	15716€

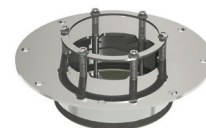

Válvula anti-implosión con  
unión embrizada

Ø180	ZUTEI104-100180	1481€
Ø200	ZUTEI104-100200	1664€
Ø250	ZUTEI104-100250	2125€
Ø300	ZUTEI104-100300	2568€
Ø350	ZUTEI104-100350	3048€
Ø400	ZUTEI104-100400	3520€

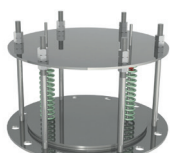

Válvula antiexplosión con  
unión embrizada

Ø180	ZUTEI630180	2278€
Ø200	ZUTEI630200	2363€
Ø250	ZUTEI630250	2680€
Ø300	ZUTEI630300	2837€
Ø350	ZUTEI630350	3310€



Clapeta manual embrizada

Ø150	AK-HT150	2457€
Ø200	AK-HT200	3273€
Ø250	AK-HT250	3558€
Ø300	AK-HT300	3840€
Ø350	AK-HT350	4696€
Ø400	AK-HT400	5556€
Ø450	AK-HT450	6412€
Ø500	AK-HT500	7265€
Ø550	AK-HT550	7993€
Ø600	AK-HT600	8719€
Ø650	AK-HT650	9443€
Ø700	AK-HT700	10171€
Ø750	AK-HT750	10899€
Ø800	AK-HT800	11624€

## CÓMO CORTAR UN MÓDULO CORTABLE DE DW-KL

### INSTRUCCIONES DE CORTE

1

Cortar el tubo exterior por la parte lisa (a la medida requerida)



2

Podrás ver el aislante rígido

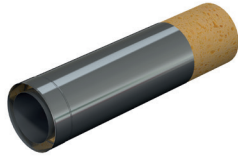

3

Cortar el aislante alrededor del tubo interior

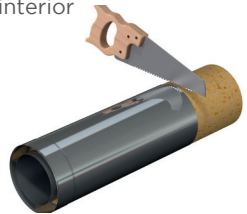

4

Podrás ver la parte hembra del tubo interior

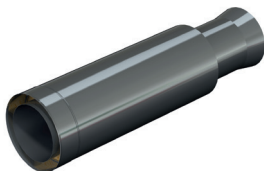

5

Empujar El tubo interior hasta que sobresalga por el otro lado la parte lisa

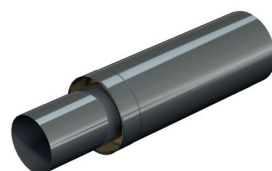

6

Asegurar un margen mínimo de 20 mm entre el corte y el tubo exterior

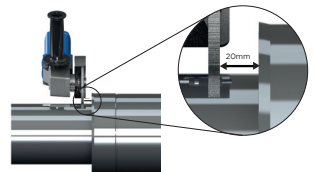

7

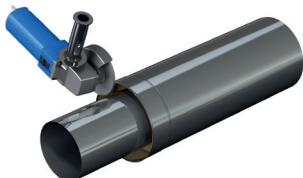

8

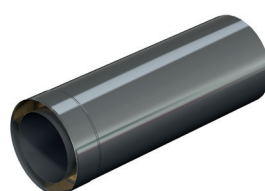



ACHTUNG!  
VERBODEN TOEGANG

80

UNUSUAL - EXCEPTIONNEL

LONG  
VEHICLE

PB UT 1139

www.FAYMONVILLE.COM



# Índice

<b>CHIMENEAS AUTOPORTANTES</b>	<b>200</b>
FSA	202
FSB	203
FSA-X	204
FSC	205
Estructuras autoportantes	206
<b>SILENCIADORES</b>	<b>211</b>

# Chimeneas industriales



# 198

# CHIMENEAS AUTOPORTANTES



## SERIE FSA

*Chimenea de doble pared aislada con un conducto interior y tubo exterior autoportante.*

**Uso**  
Ciclos combinados, cogeneración, calderas, grupos electrógenos, extracciones químicas, biomasa...

**Sistema de anclaje**  
Brida base y/o jaula de anclaje.

**Elemento autoportante**  
Tubo exterior.

**Conducto de evacuación**  
AISI 304 / AISI 316

**Aislamiento**  
A1 - Lana de roca  
A2- Lana mineral  
Espesor 30, 50, o 100 mm

**Ventilación interior**  
Ventilación interior en toda la altura

**Tubo exterior**  
S235 / S275 / S355 / AISI 304

**Conductos interiores**  
1

**Acabado superficial**  
Pintado RAL  
Acero galvanizado  
Inoxidable brillante, mate, pulido.



## SERIE FSA-X

*Chimenea de doble pared aislada con dos o más conductos interiores y tubo exterior autoportante.*

**Uso**  
Ciclos combinados, cogeneración, calderas, grupos electrógenos, extracciones químicas, biomasa...

**Sistema de anclaje**  
Brida base y/o jaula de anclaje.

**Elemento autoportante**  
Tubo exterior.

**Conducto de evacuación**  
AISI 304 / AISI 316

**Aislamiento**  
A1 - Lana de roca  
A2- Lana mineral  
Espesor 30, 50, o 100 mm

**Ventilación interior**  
Ventilación interior en toda la altura

**Tubo exterior**  
S235 / S275 / S355 / AISI 304

**Conductos interiores**  
≥ 2

**Acabado superficial**  
Pintado RAL  
Acero galvanizado  
Inoxidable brillante, mate, pulido.

# JEREMIAS INDUSTRIAL



## Servicio

Estudio de requerimientos de la instalación.  
Cálculo de diámetros, espesores, materiales.  
Estudio de la zona de instalación.  
Estimación de costes.  
Estudio de viabilidad.  
Comunicación continua con el cliente.  
Seguimiento de la oferta.



## Cálculo

Cálculo estático.  
Informe de cargas en puntos críticos.  
Cálculo de frecuencia de resonancia.  
Cálculos sísmicos.



## Diseño 2D/3D

Planos de transporte.  
Plano jaula de anclaje.  
Lista de materiales.  
Planos de diseño.



## Producción

Soldadura longitudinal.  
Corte láser, plasma.  
Curvadoras, grandes diámetros, piezas especiales.



## Logística

Organización de transporte.  
Gestión de grúas y montaje.  
Planificación.



## Montaje

Mediciones.  
Montadores cualificados.  
Supervisión de montaje.  
Seguimiento de plazos.



## SERIE FSB

*Chimenea de doble pared aislada con **conducto interior autoportante** para evacuación de humos*

### Uso

Calderas, extracciones químicas...

### Sistema de anclaje

Brida base y/o jaula de anclaje.

### Elemento autoportante

Tubo interior.

### Conducto de evacuación

AISI 304 / AISI 316  
S235 / S355 / S275

### Aislamiento

A1 - Lana de roca  
A2- Lana mineral  
Espesor 30, 50, o 100 mm

### Tubo exterior

Revestimiento en AISI 304  
o AISI 316, aluminio,  
acero galvanizado

### Conductos interiores

1

### Acabado superficial

Brillante, mate, pulido.  
Soldado / remachado  
Pintado RAL



## SERIE FSC

*Torre de ventilación en simple pared*

### Uso

Impulsión, extracción.  
Ventilación y aire acondicionado...

### Sistema de anclaje

Brida base

### Elemento autoportante

Conducto de simple pared

### Conducto de evacuación

AISI 304 / AISI 316

### Acabado superficial

Pintado RAL  
Acero inoxidable brillante,  
mate, pulido.

## SERIE FSA

Chimenea autoportante de doble pared con conducto exterior autoportante y conducto interior aislado para evacuación de humos.

El hueco interior ventilado entre aislamiento y tubo exterior asegura que la temperatura del conducto exterior nunca supere los límites estructurales.

- 1 Terminal de salida**  
Permite la ventilación de todo el conducto.
- 2 Amortiguador de oscilaciones**  
Reduce la influencia de oscilaciones, garantizando la estabilidad de la chimenea.
- 3 Conducto interior de evacuación**  
Material: AISI 316, AISI 304.  
Espesor: 1.5 - 2 - 3 mm.
- 4 Aislamiento**  
Lana de roca de alta densidad con malla galvanizada.  
Espesores: 30 hasta 100 mm, en función de la temperatura.
- 5 Escalera**  
Escalera tipo rail único o con jaula de seguridad con plataformas intermedias de descanso.
- 6 Toma de muestras de los humos**  
Permite el acceso al interior o acoplar equipos para tomas de muestra de humos.
- 7 Plataforma para toma de muestras**  
Ángulos desde 135° hasta 360°.  
Ancho desde 800 hasta 2500 mm.  
Fabricada en acero S235JR galvanizado (otros materiales disponibles).
- 8 Conexión de humos**  
Conexión embridada, a tubo existente, estándar Jeremías, o según petición.
- 9 Inspección de limpieza**  
Inspección para mantenimiento y limpieza.  
Ø250, Ø600 mm, otros.
- 10 Drenaje interior condensados**  
Placa base inclinada para asegurar el drenaje adecuado de condensados.
- 11 Ventilación int/ext.**  
Rejilla de ventilación para asegurar una corriente de aire continua desde la base hasta el terminal.
- 12 Desagüe tubo exterior**
- 13 Brida base**  
Cartelas de refuerzo
- 14 Jaula de anclaje**

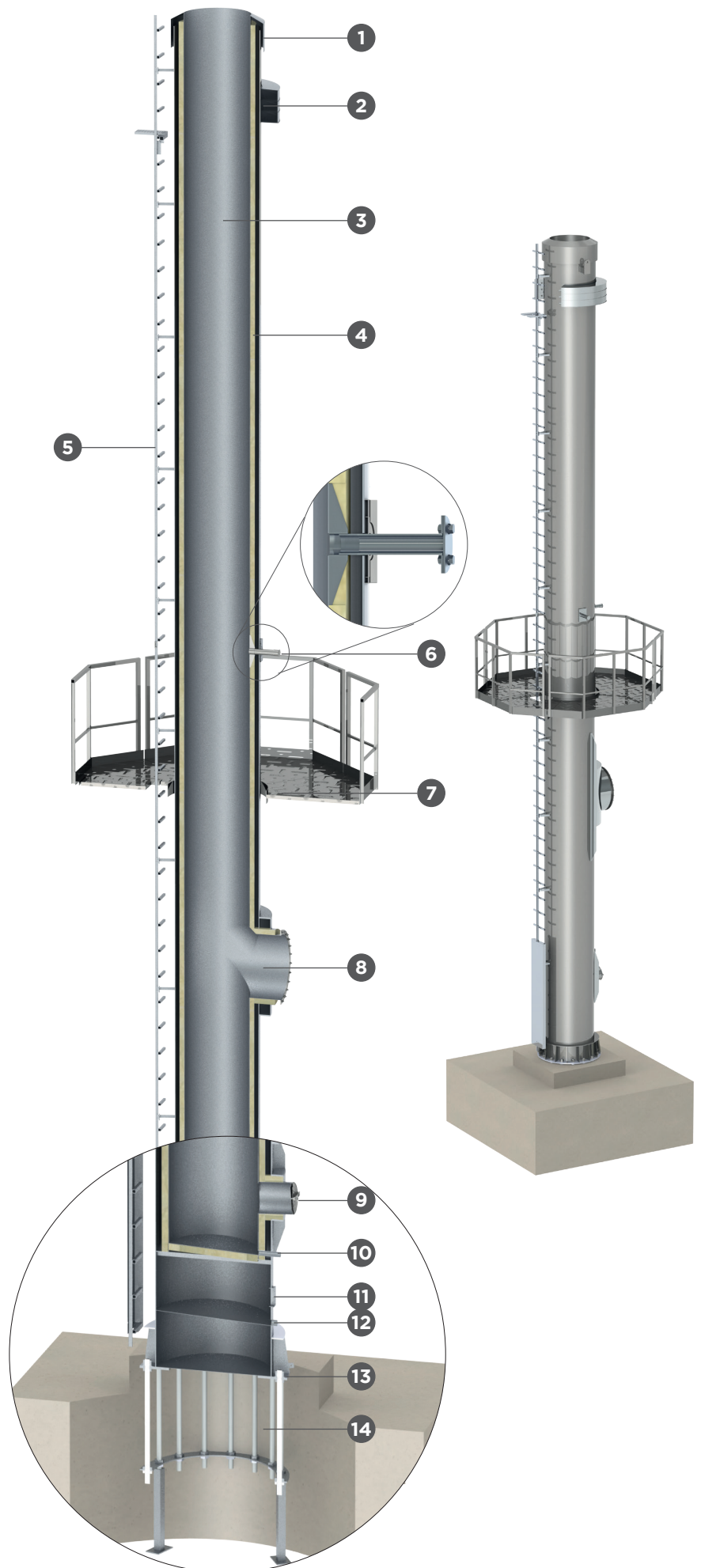

## SERIE FSB

Chimenea de doble pared aislada con **conducto interior autoportante** para evacuación de humos y recubrimiento exterior.

- 1 Terminal abierto de salida**
- 2 Conducto interior de evacuación**  
Material: AISI 316, AISI 304, S235, S275, S355
- 3 Recubrimiento exterior**  
Material: AISI 316, AISI 304, Aluminio, otros.  
Espesor: 0.8 - 1.5 - 2 mm.
- 4 Escalera**  
Escalera tipo rail único o con jaula de seguridad con plataformas intermedias de descanso.
- 5 Soporte de carga (opcional)**  
Ayuda a reducir cargas en la base para reducir espesor del tubo estructural y cimentación.
- 6 Aislamiento**  
Lana de roca de alta densidad con malla galvanizada.  
Espesores: 30 hasta 100 mm en función de la temperatura.
- 7 Conexión de humos**  
Conexión embridada, a tubo existente, estándar Jeremias, según petición.
- 8 Inspección de limpieza**  
Inspección para mantenimiento y limpieza. Ø250, Ø600 mm, otros.
- 9 Placa base**

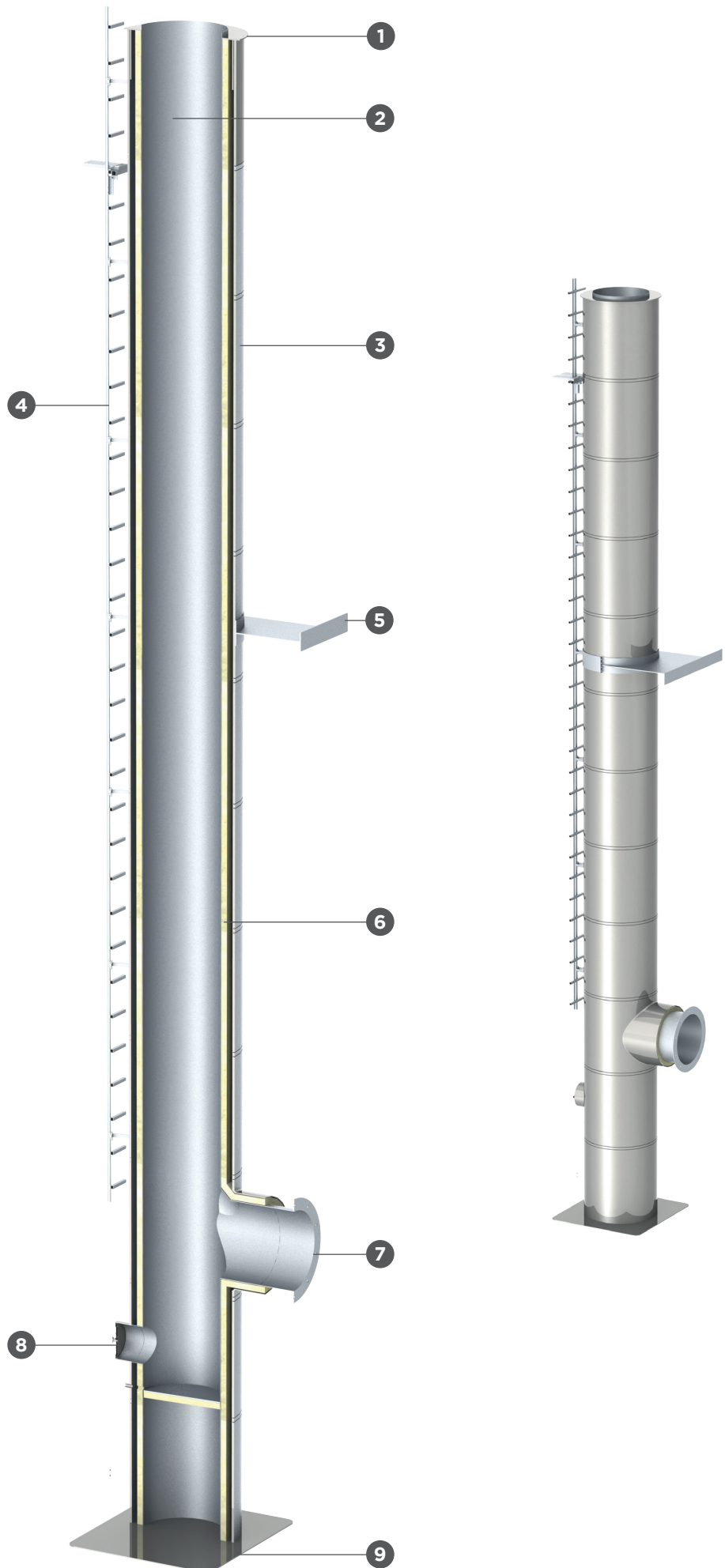

## SERIE FSA-X

*Chimenea autoportante de doble pared con dos o más conductos interiores para evacuación de humos y tubo exterior autoportante.*

*El hueco interior ventilado entre aislamiento y tubo exterior asegura que la temperatura del conducto exterior nunca supere los límites estructurales.*

- 1 Terminal de salida**  
Permite la ventilación de todo el conducto.
- 2 Conducto interior de evacuación**  
Material: AISI 316, AISI 304, S235, S355  
Espesor: 1.5, 2.3 mm.
- 3 Aislamiento**  
Lana de roca de alta densidad con malla galvanizada.  
Espesores: 30 hasta 100 mm, en función de la temperatura.
- 4 Plataforma para toma de muestras**  
Ángulos desde 135 hasta 360°  
Ancho desde 800 hasta 2500 mm.
- 5 Conexión de humos (dos o más)**  
Conexión embridada, a tubo existente, estándar Jeremias, según petición.
- 6 Inspección de limpieza**  
Inspección mantenimiento / limpieza  
Ø250, 600 mm, otros.
- 7 Drenaje interior condensados**
- 8 Ventilación int/ext.**  
Rejilla de ventilación para asegurar una corriente de aire continua desde la base hasta el terminal.
- 9 Desagüe tubo exterior**
- 10 Brida base**  
Cartelas de refuerzo
- 11 Jaula de anclaje**

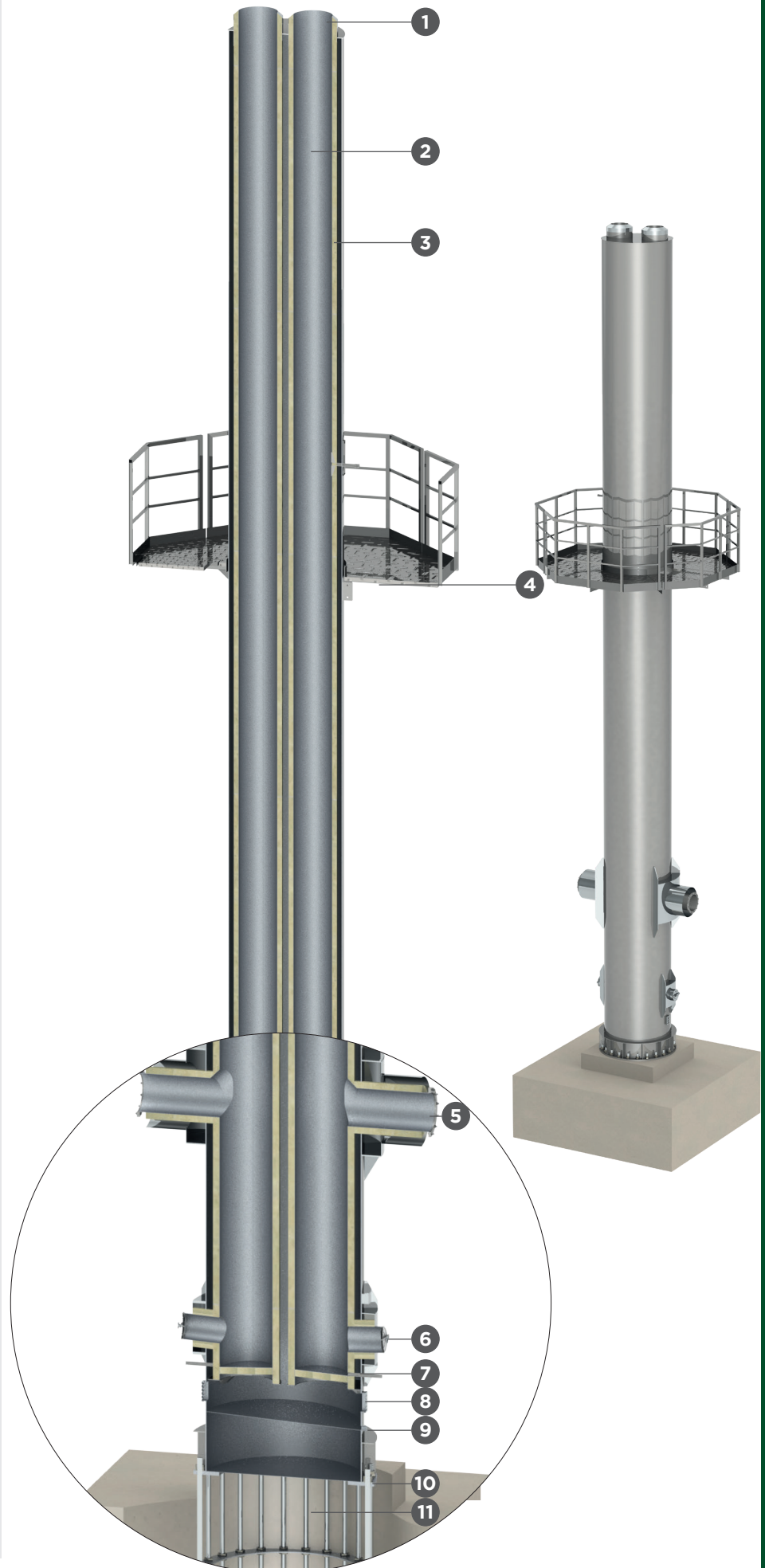

## TORRES DE VENTILACIÓN FSC

*Terminales para ventilación fabricado en simple pared, para expulsión e impulsión de aire.*

### TERMINAL LAMAS

- 1** Cierre superior
- 2** Apertura de 180° hasta 360°
- 3** Conducto de acero inoxidable con acabado pulido o brillante
- 4** Placa base

### TERMINAL LAMAS



### TIPOS DE CIERRES



### TERMINAL ABIERTO

- 1** Rejilla antipájaros
- 2** Conducto de acero inoxidable con acabado pulido o brillante
- 3** Separador de agua
- 4** Desagüe
- 5** Placa base

### TERMINAL ABIERTO

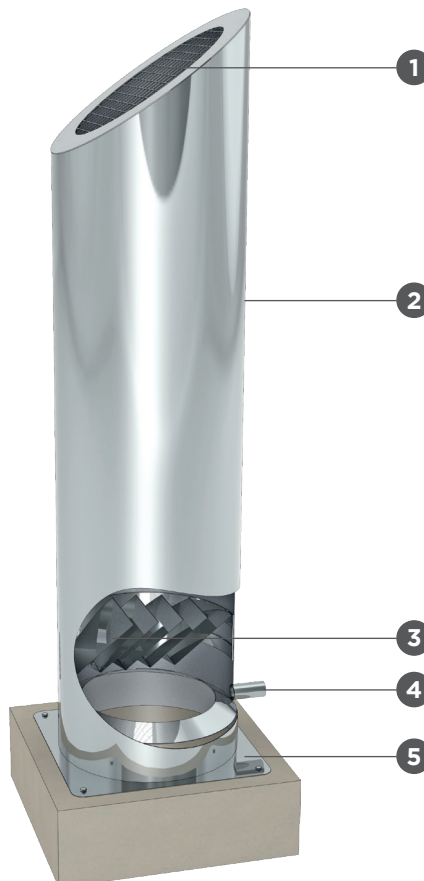

### ACABADO LAMAS

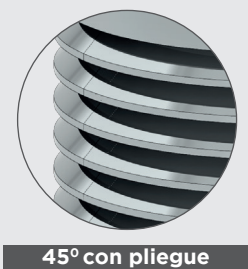
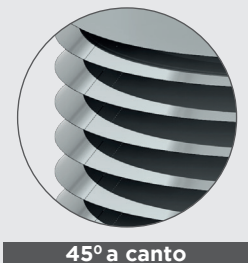

## ESTRUCTURAS METÁLICAS

Estructuras autoportantes y mástiles con fijaciones para sistemas de evacuación de humos modulares Jeremias (DW-ECO, DW-KL...). Las soluciones con estructuras son a veces la solución ideal en proyectos donde el anclaje a suelo o la accesibilidad de la zona de montaje no permite una solución autoportante. La flexibilidad en el montaje tanto físico como temporal es la mayor ventaja de estas soluciones.

### Características del proyecto

Cálculo estático de la estructura según normativa.  
Estudio en función de la zona, espacios en obra.  
necesidades específicas...

Detalles constructivos:

Fijación mediante zapata de hormigón y/o placa base.

Perfilería tipo: IP, HEB, perfil cuadrado o circular, en L...

Materiales: S235JR, S275JR, galvanizado, AISI 304, AISI 316...

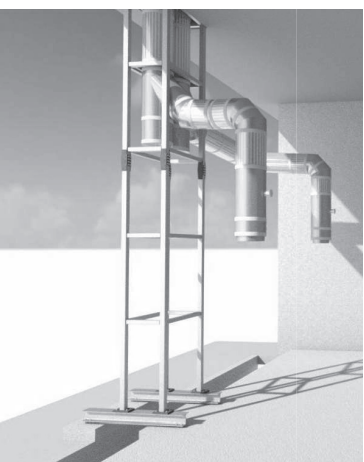

Orejetas de izado.

Estructura premontada en fábrica o en obra.

Montaje de conducto modular en fábrica o en obra en función de la instalación.

### Opciones complementarias

Plataforma de toma de muestra.

Escalera tipo jaula o de rail.

Pararrayos

Luces de balizaje.

Acabado pintado RAL, brillante, mate...

Tratamientos especiales en función de la zona (C3, C4, C5)



## DETALLES CONSTRUCTIVOS

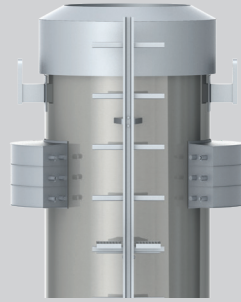
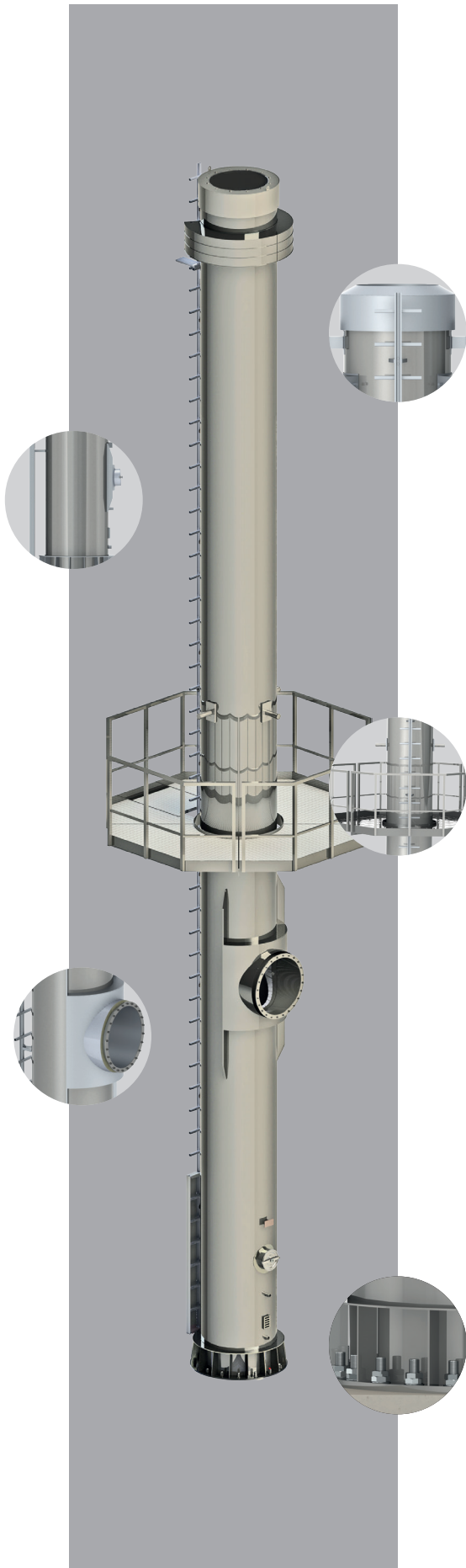

**Terminal de salida libre:** Permite la dilatación del tubo interior y la ventilación interior de la chimenea.

**Compensador de oscilaciones:** Debido al efecto del viento puede ser necesaria la colocación de un compensador. Con sus cámaras interiores rellenas parcialmente de líquido se amortiguan las oscilaciones por este efecto.

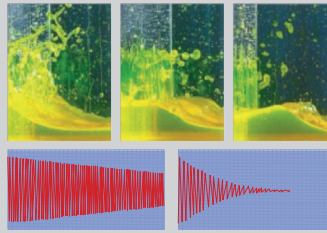

Oscilaciones sin compensador

Oscilaciones con compensador

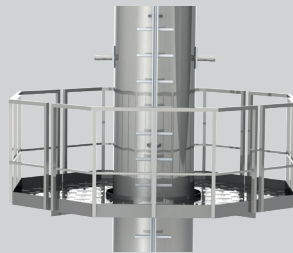

**Plataforma**

Plataforma para acceder a las tomas de muestra. Fabricada en acero S235JR galvanizado con suelo de trámex. Barandilla, dimensiones y ángulos según necesidades.

**Escalera**

Tipo rail único con arnés de seguridad o tipo escalerilla de gato con jaula de Ø700 mm.



**Tomas de muestra**

Inspecciones para conexión de equipos de tomas de muestra e inspección.

Instaladas a 1,5 m de altura respecto a la plataforma de mediciones y a 5 x Ø int. de la conexión horizontal de humos.

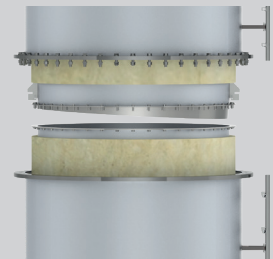
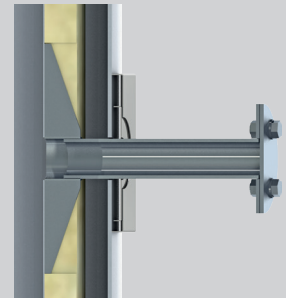

**Chimenea en varias secciones**

Cuando la chimenea se fabrica en varias secciones debido a las dimensiones o a requerimientos especiales, cada sección se une mediante bridas atornilladas tanto el conducto interior como el exterior.

De esta forma se garantiza una unión correcta y estanca.

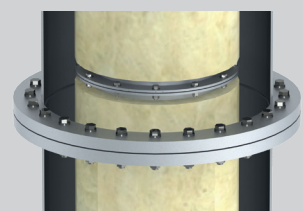

**Detalle base chimenea**

- 1** Inspección de limpieza.
- 2** Desagüe interior.
- 3** Ventilación hueco interior.
- 4** Desagüe conducto exterior.

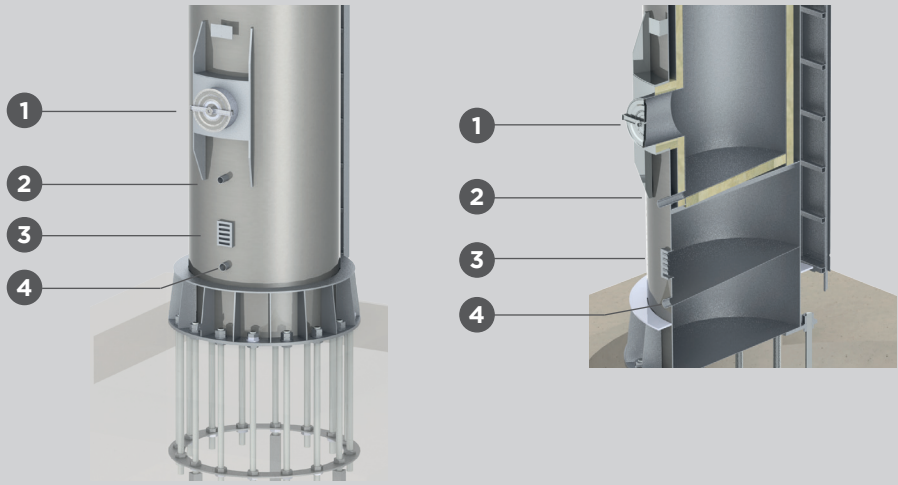

**Conexión de humos**

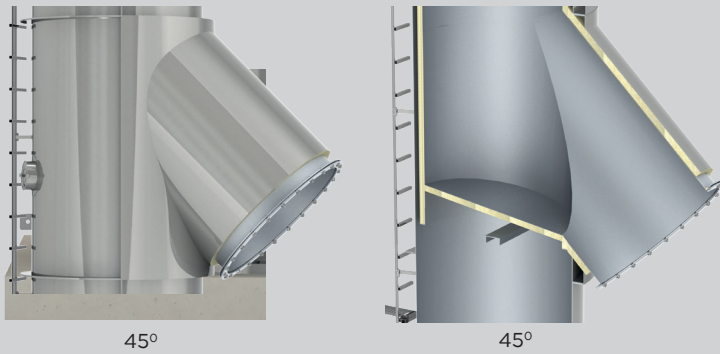

Diferentes ángulos de conexión en función de las necesidades de la instalación. Conexión embreadada, soldada, a tubo Jeremias, etc. Camisa de protección exterior para recubrir soldaduras y cerrar la conexión.

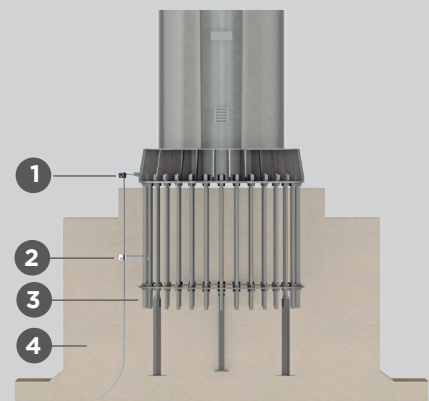
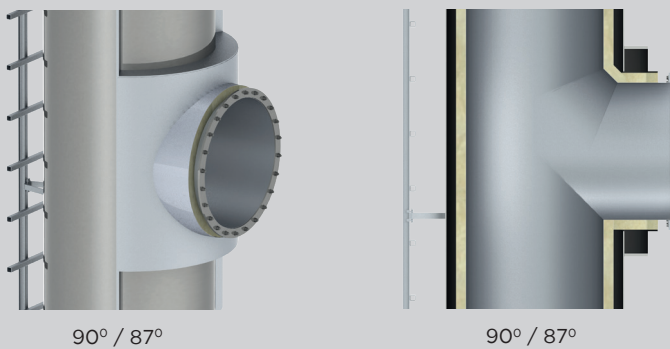

**Jaula de anclaje**

Doble anillo de centrado con pernos de anclaje. Se suministra previo a la chimenea, para su instalación con la zapata de hormigón.

- 1** Toma de tierra.
- 2** Conexionado de la toma de tierra.
- 3** Jaula de anclaje
- 4** Zapata de hormigón

**Fijación aislamiento**

Fijación del aislamiento con plato de acero y pins soldados al tubo interior. Mediante este sistema, se asegura una fijación correcta del aislamiento así como un aislamiento continuo a lo largo de toda la vertical.

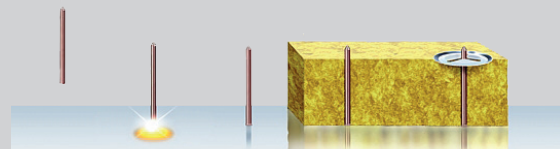

**TRATAMIENTOS SUPERFICIALES DEL TUBO EXTERIOR**

C3	Moderado	Zonas de baja contaminación, y ambientes poco agresivos. Áreas de producción con niveles medios de humedad, y zonas habitables.
C4	Alto	Zonas de contaminación y ambientes agresivos medios. Ambientes químicos y piscinas.
C5	Muy alto	Zonas costeras con niveles altos de humedad, ambientes industriales agresivos, condensaciones continuas, y áreas con contaminación elevada.

Mediante los certificados CE y controles de calidad en fábrica, se garantiza el cumplimiento de todos los requisitos para un correcto funcionamiento de la chimenea y una durabilidad apropiada para la cada proyecto.

”

Los productos **Jeremias** pasan estrictos controles de calidad para asegurar su correcto funcionamiento y durabilidad.



## Certificaciones

- Certificados según normativas vigentes
  - Marcado CE según normativa de chimeneas autoportantes EN 13084-7.
  - Marcado CE según normativa EN 1090-1 para estructuras metálicas.
- Cálculo estático según Eurocódigo.
- Cálculos sísmicos y de viento según región o país

## Calidad

- Control de material primas
- Control de calidad durante todas las etapas de fabricación
  - Posibilidad de control de soldaduras por líquidos penetrantes.
  - Controles y tolerancias dimensionales
  - Procedimientos de soldadura homologados
  - Soldadores homologados para soldadura estructural
- Control de acabados:
  - Capas de pintura
  - Pulido, granallado, decapado...



## ¿Necesitas asesoramiento técnico?

Solicita asesoramiento y/o presupuesto personalizado sin compromiso.

[industrial@jeremias.es](mailto:industrial@jeremias.es)



# 211

## Silenciadores

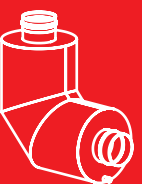

## CARACTERÍSTICAS DEL PRODUCTO

### Silenciadores de absorción ASD / AED

Son silenciadores pasivos en los que el interior del tubo está perforado de modo que las ondas sonoras llegan al aislamiento, que, al ser acolchado, absorbe las ondas sonoras por fricción, transformándolas en calor. Este tipo de silenciadores son adecuados para medias y altas frecuencias y reducen por igual en todas las frecuencias, aunque la reducción que se consigue no es muy alta.

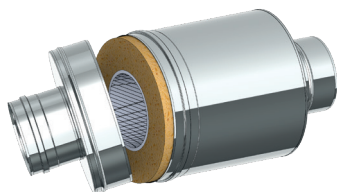

### Silenciadores combinados KSD / KED

Este tipo de silenciadores combinan una parte de absorción y cámaras de resonancia. Las cámaras de resonancia constan de unos puntos de entrada de las ondas sonoras y al rebotar estas ondas en el extremo de la cámara, se compensan con las que van en dirección contraria reduciendo así el volumen. La reducción que se consigue en resonancia es muy alta, pero muy localizada en una frecuencia concreta. Es por eso que se utilizan para bajas frecuencias y con varias cámaras de resonancia para reducir en un rango mayor de frecuencias.

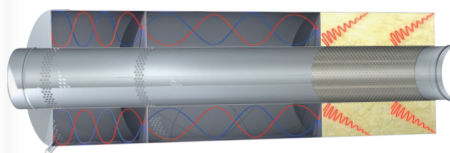

### Cuerpos interiores silenciadores SDK

Están diseñados para hacer una reducción de ruido moderada en instalaciones ya terminadas, introduciendo el cuerpo del silenciador por el extremo de la chimenea, el cual queda colgando del extremo, siendo así muy sencillo de instalar. Hay que tener en cuenta la reducción de sección que produce para confirmar que el tiro de la chimenea no se ve afectado. Funciona igual que los silenciadores de absorción, actuando bien en medias y altas frecuencias.

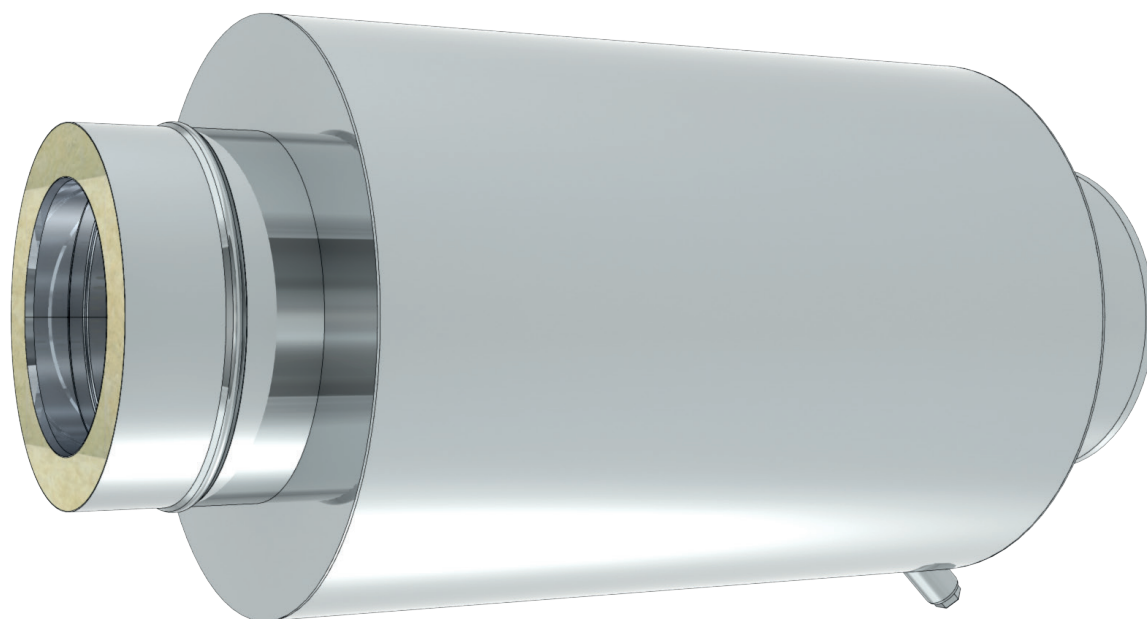



# SILENCIADORES



Módulo silenciador seco  
DW ECO 1.0 304



Módulo silenciador seco  
DW ECO 1.0 316



Módulo silenciador seco  
DW ECO 2.0 304



Módulo silenciador seco  
DW ECO 2.0 316



Módulo silenciador seco  
EW-ECO 304

Ø100	908-DWECO5300100	214€	Ø100	909-DWECO5300100	261€	Ø100	-	-	Ø100	-	-	Ø100	670-EWEC5300100	228€
Ø130	908-DWECO5300130	221€	Ø130	909-DWECO5300130	267€	Ø130	660-DWECO5300130	234€	Ø130	661-DWECO5300130	285€	Ø130	670-EWEC5300130	245€
Ø150	908-DWECO5300150	272€	Ø150	909-DWECO5300150	303€	Ø150	660-DWECO5300150	286€	Ø150	661-DWECO5300150	317€	Ø150	670-EWEC5300150	304€
Ø180	908-DWECO5300180	308€	Ø180	909-DWECO5300180	359€	Ø180	660-DWECO5300180	322€	Ø180	661-DWECO5300180	382€	Ø180	670-EWEC5300180	342€
Ø200	908-DWECO5300200	358€	Ø200	909-DWECO5300200	425€	Ø200	660-DWECO5300200	379€	Ø200	661-DWECO5300200	445€	Ø200	670-EWEC5300200	400€
Ø250	-	-	Ø250	-	-	Ø250	660-DWECO5300250	457€	Ø250	661-DWECO5300250	537€	Ø250	670-EWEC5300250	486€
Ø300	-	-	Ø300	-	-	Ø300	660-DWECO5300300	560€	Ø300	661-DWECO5300300	649€	Ø300	670-EWEC5300300	602€
Ø350	-	-	Ø350	-	-	Ø350	660-DWECO5300350	707€	Ø350	661-DWECO5300350	827€	Ø350	670-EWEC5300350	752€
Ø400	-	-	Ø400	-	-	Ø400	660-DWECO5300400	782€	Ø400	661-DWECO5300400	984€	Ø400	670-EWEC5300400	833€
Ø450	-	-	Ø450	-	-	Ø450	660-DWECO5300450	846€	Ø450	661-DWECO5300450	1068€	Ø450	670-EWEC5300450	905€
Ø500	-	-	Ø500	-	-	Ø500	660-DWECO5300500	907€	Ø500	661-DWECO5300500	1162€	Ø500	670-EWEC5300500	959€
Ø550	-	-	Ø550	-	-	Ø550	660-DWECO5300550	1035€	Ø550	661-DWECO5300550	1307€	Ø550	670-EWEC5300550	1103€
Ø600	-	-	Ø600	-	-	Ø600	660-DWECO5300600	1275€	Ø600	661-DWECO5300600	1426€	Ø600	670-EWEC5300600	1347€



Módulo silenciador seco  
EW-ECO 316



Módulo silenciador húmedo  
hasta 25dB



Módulo silenciador húmedo hasta 15dB  
DW-ECO 1.0 316



Módulo silenciador húmedo hasta 25dB  
DW-ECO 2.0 316



Módulo silenciador húmedo hasta 15dB  
DW-ECO 2.0 316

Ø100	671-EWEC5300100	279€	Ø100	909-DWECO534150100	1432€	Ø100	661-DWECO534150100	1504€	Ø100	909-DWECO534250100	1888€	Ø100	661-DWECO534250100	1979€
Ø130	671-EWEC5300130	303€	Ø130	909-DWECO534150130	1478€	Ø130	661-DWECO534150130	1530€	Ø130	909-DWECO534250130	1914€	Ø130	661-DWECO534250130	1983€
Ø150	671-EWEC5300150	338€	Ø150	909-DWECO534150150	1504€	Ø150	661-DWECO534150150	1561€	Ø150	909-DWECO534250150	1979€	Ø150	661-DWECO534250150	2039€
Ø180	671-EWEC5300180	403€	Ø180	909-DWECO534150180	1806€	Ø180	661-DWECO534150180	1877€	Ø180	909-DWECO534250180	2414€	Ø180	661-DWECO534250180	2499€
Ø200	671-EWEC5300200	478€	Ø200	909-DWECO534150200	1845€	Ø200	661-DWECO534150200	1922€	Ø200	909-DWECO534250200	2476€	Ø200	661-DWECO534250200	2566€
Ø250	671-EWEC5300250	574€	Ø250	-	-	Ø250	661-DWECO534150250	2499€	Ø250	-	-	Ø250	661-DWECO534250250	2748€
Ø300	671-EWEC5300300	687€	Ø300	-	-	Ø300	661-DWECO534150300	3032€	Ø300	-	-	Ø300	661-DWECO534250300	3599€
Ø350	671-EWEC5300350	880€	Ø350	-	-	Ø350	661-DWECO534150350	3147€	Ø350	-	-	Ø350	661-DWECO534250350	3928€
Ø400	671-EWEC5300400	1045€	Ø400	-	-	Ø400	661-DWECO534150400	4152€	Ø400	-	-	Ø400	661-DWECO534250400	4426€
Ø450	671-EWEC5300450	1128€	Ø450	-	-	Ø450	661-DWECO534150450	5671€	Ø450	-	-	Ø450	661-DWECO534250450	5865€
Ø500	671-EWEC5300500	1229€	Ø500	-	-	Ø500	661-DWECO534150500	6625€	Ø500	-	-	Ø500	661-DWECO534250500	6988€
Ø550	671-EWEC5300550	1378€	Ø550	-	-	Ø550	661-DWECO534150550	8608€	Ø550	-	-	Ø550	661-DWECO534250550	8970€
Ø600	671-EWEC5300600	1507€	Ø600	-	-	Ø600	661-DWECO534150600	9120€	Ø600	-	-	Ø600	661-DWECO534250600	9442€

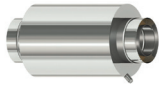

Módulo silenciador húmedo hasta 15dB  
EW-ECO 316



Módulo silenciador húmedo hasta 25dB  
EW-ECO 316



Silenciador 90° hasta 25 dB



Silenciador de absorción hasta 10 dB

Ø100	67I-EWEC534150100	1191€	Ø100	67I-EWEC534250100	1511€	Ø100	-	-	Ø100	ASD-T0100	281€
Ø130	67I-EWEC534150130	1229€	Ø130	67I-EWEC534250130	1530€	Ø130	-	-	Ø130	ASD-T0130	385€
Ø150	67I-EWEC534150150	1248€	Ø150	67I-EWEC534250150	1580€	Ø150	-	-	Ø150	ASD-T0150	475€
Ø180	67I-EWEC534150180	1505€	Ø180	67I-EWEC534250180	1930€	Ø180	ASD-W250180	2322€	Ø180	ASD-T0180	605€
Ø200	67I-EWEC534150200	1533€	Ø200	67I-EWEC534250200	1978€	Ø200	ASD-W250200	2596€	Ø200	ASD-T0200	686€
Ø250	67I-EWEC534150250	1988€	Ø250	67I-EWEC534250250	2190€	Ø250	ASD-W250250	3865€	Ø250	ASD-T0250	805€
Ø300	67I-EWEC534150300	2415€	Ø300	67I-EWEC534250300	2870€	Ø300	-	-	Ø300	ASD-T0300	1204€
Ø350	67I-EWEC534150350	2503€	Ø350	67I-EWEC534250350	3129€	Ø350	-	-	Ø350	ASD-T0350	1407€
Ø400	67I-EWEC534150400	3308€	Ø400	67I-EWEC534250400	3529€	Ø400	-	-	Ø400	ASD-T0400	1660€
Ø450	67I-EWEC534150450	4519€	Ø450	67I-EWEC534250450	4677€	Ø450	-	-			
Ø500	67I-EWEC534150500	5282€	Ø500	67I-EWEC534250500	5568€	Ø500	-	-			
Ø550	67I-EWEC534150550	6583€	Ø550	67I-EWEC534250550	7067€	Ø550	-	-			
Ø600	67I-EWEC534150600	7271€	Ø600	67I-EWEC534250600	7529€	Ø600	-	-			



Cuerpo silenciador  
L=1000mm hasta 5 dB



Cuerpo silenciador  
L=1500mm hasta 8 dB



Cuerpo silenciador  
L=2000mm hasta 10 dB



Cuerpo silenciador  
L=3000mm hasta 15 dB

Ø100	SDK10100	703€	Ø100	SDK20100	728€	Ø100	SDK30100	756€	Ø100	SDK40100	808€
Ø130	SDK10130	753€	Ø130	SDK20130	799€	Ø130	SDK30130	844€	Ø130	SDK40130	934€
Ø150	SDK10150	753€	Ø150	SDK20150	799€	Ø150	SDK30150	844€	Ø150	SDK40150	934€
Ø180	SDK10180	801€	Ø180	SDK20180	854€	Ø180	SDK30180	908€	Ø180	SDK40180	1018€
Ø200	SDK10200	845€	Ø200	SDK20200	948€	Ø200	SDK30200	1048€	Ø200	SDK40200	1249€
Ø250	SDK10250	1026€	Ø250	SDK20250	1106€	Ø250	SDK30250	1188€	Ø250	SDK40250	1349€
Ø300	SDK10300	1090€	Ø300	SDK20300	1181€	Ø300	SDK30300	1268€	Ø300	SDK40300	1446€
Ø350	SDK10350	1216€	Ø350	SDK20350	1314€	Ø350	SDK30350	1414€	Ø350	SDK40350	1612€
Ø400	SDK10400	1422€	Ø400	SDK20400	1508€	Ø400	SDK30400	1597€	Ø400	SDK40400	1822€



## SILENCIADORES

Nota: Ø C. Diámetro del cuerpo silenciador.



Silenciador PPS hasta 20 dB



Silenciador PPS hasta 30 dB



Silenciador inox hasta 20 dB



Silenciador inox hasta 25 dB



Silenciador inox hasta 35 dB

Ø60	-	-	Ø60	-	-	Ø60	ASD-H200060	593€	Ø60	ASD-H250060	757€	Ø60	ASD-H350060	924€
Ø80	ASD-PP200080	731€	Ø80	ASD-PP300080	911€	Ø80	ASD-H200080	695€	Ø80	ASD-H250080	896€	Ø80	ASD-H350080	1101€
Ø100	-	-	Ø100	-	-	Ø100	ASD-H200100	865€	Ø100	ASD-H250100	1042€	Ø100	ASD-H350100	1229€
Ø130	-	-	Ø130	-	-	Ø130	ASD-H200130	1056€	Ø130	ASD-H250130	1288€	Ø130	ASD-H350130	1530€

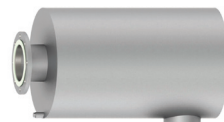

Silenciador absorción hasta 15 dB alineado    Silenciador absorción hasta 25 dB alineado    Silenciador absorción hasta 15 dB en L    Silenciador absorción hasta 25 dB en L

Ø80	AED-FL150080	1206€	Ø80	AED-FL250080	1572€	Ø80	AEL-FL150080	1410€	Ø80	AEL-FL250080	1844€
Ø100	AED-FL150100	1401€	Ø100	AED-FL250100	1896€	Ø100	AEL-FL150100	1607€	Ø100	AEL-FL250100	2187€
Ø125	AED-FL150125	1872€	Ø125	AED-FL250125	2759€	Ø125	AEL-FL150125	2059€	Ø125	AEL-FL250125	3039€
Ø150	AED-FL150150	2545€	Ø150	AED-FL250150	3913€	Ø150	AEL-FL150150	2769€	Ø150	AEL-FL250150	4302€
Ø200	AED-FL150200	3887€	Ø200	AED-FL250200	6031€	Ø200	AEL-FL150200	4149€	Ø200	AEL-FL250200	6417€
Ø250	AED-FL150250	5945€	Ø250	AED-FL250250	8836€	Ø250	AEL-FL150250	6156€	Ø250	AEL-FL250250	9346€



Silenciador combinado hasta 35 dB alineado



Silenciador combinado hasta 35 dB en L

Ø80	KED-FL350080	3670€	Ø80	KEL-FL350080	3932€
Ø100	KED-FL350100	4680€	Ø100	KEL-FL350100	4982€
Ø125	KED-FL350125	5486€	Ø125	KEL-FL350125	5890€
Ø150	KED-FL350150	6386€	Ø150	KEL-FL350150	6864€
Ø200	KED-FL350200	8478€	Ø200	KEL-FL350200	9108€
Ø250	KED-FL350250	11897€	Ø250	KEL-FL350250	12749€





RESIDENCIAL

# Sistemas de ventilación eficientes

ekkoair  
by jeremias

# 217

# ¿Qué es Ekkoair?

**Ekkoair**  
by jeremias

**EKKOAIR by Jeremias.** Un sistema más completo y eficiente.

**Ekkoair by Jeremias** es nuestra solución integral de Ventilación Mecánica Controlada (VMC) para el ámbito residencial y terciario, diseñada para garantizar calidad de aire interior, eficiencia energética y máximo confort. No hablamos de recuperación de calor o extracción de aire, sino de un sistema completo que integra ventilación de simple y doble flujo, así como ventilación específica para cocinas, cumpliendo con el CTE y contribuyendo de forma directa a mejorar la calificación energética del edificio.

Cuenta con sistemas individuales o colectivos, de simple flujo y de doble flujo con recuperación de calor.

Todo el sistema está concebido para reducir tiempos de instalación, minimizar el espacio necesario de instalación en obra y asegurar estanqueidad, eficiencia y bajo consumo.

En definitiva, Ekkoair by Jeremias es una solución eficiente, compacta y técnica que permite al proyectista y al instalador trabajar sin complicaciones y al usuario disfrutar del confort de su vivienda.

**EFICIENTE  
+  
ÓPTIMO**  
Consumo de energía casi nulo



**ALTA EFICIENCIA  
BAJO CONSUMO**



**MEJORES CALIFICACIONES  
ENERGÉTICAS**



**FACILIDAD  
DE LA INSTALACIÓN**



**MENOS CONSUMOS  
PARA EL USUARIO**



**REDUCCIÓN DE TIEMPO  
DE INSTALACIÓN**



**REDUCCIÓN DE ESPACIO**



**MEJORA DEL RENDIMIENTO  
DE LA INSTALACIÓN**



**REDUCCIÓN DE LA  
HUELLA DE CARBONO**

Las soluciones **EKKOAIR by Jeremias** están compuestas por:



**Rejillas de entrada de aire**

Fabricadas en PVC o Aluminio



**Bocas de extracción**

Diferentes opciones en función de la estética de la estancia.



**Conductos horizontales**

EkkoFlex: Semirrígido.  
SVCH: Acero galvanizado circular.  
Termoplástico circular y rectangular.



**Conductos verticales**

SVC3: Acero galvanizado circular.  
SVC4: Acero inoxidable circular.

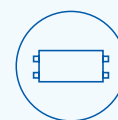

**Recuperadores de calor individuales**

GENIUS.  
LOGIC.  
HOUSE

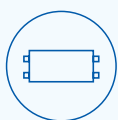

**Recuperadores de calor colectivos**

JRC



**Extractor de bajo perfil**

JET



**Extractor en línea**

INLINE

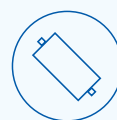

**Extractor colectivo**

JVC



**Conductos para la ventilación específica de las cocinas**

SVC3: Acero galvanizado.  
SVC4: Acero inoxidable.



# Ventilación mecánica controlada

La ventilación mecánica controlada (VMC) es un sistema de ventilación utilizado en edificios y viviendas para garantizar un intercambio de aire adecuado y controlado, con el propósito de mantener un ambiente interior saludable y confortable.

# Normativa

## VMC VENTILACIÓN MECÁNICA CONTROLADA

El Documento Básico HS3 “Calidad del aire interior” contenido en el Código Técnico de la Edificación (CTE), tiene como objetivo que “los edificios dispongan de medios para que sus recintos se puedan ventilar adecuadamente, eliminando los contaminantes que se produzcan de forma habitual durante el uso normal de los edificios, de forma que se aporte un caudal suficiente de aire exterior y se garantice la extracción y expulsión del aire viciado por los contaminantes”.

Para ello, las viviendas deben disponer de un **sistema general de Ventilación Mecánica**, con las siguientes características:

- El aire debe circular desde los locales secos (comedores, dormitorios y salas de estar) a los húmedos (cuartos de baño, aseos y cocinas).
- Los locales secos deben disponer de aberturas de admisión.
- Los locales húmedos deben disponer de aberturas de extracción.
- Se consideran los siguientes caudales mínimos para ventilación de caudal constante en locales habitables.
- Las aberturas de extracción deben conectarse a conductos de extracción y deben disponerse a una distancia del techo menor que 200 mm y a una distancia de cualquier rincón o esquina vertical mayor que 100 mm.
- Un mismo conducto de extracción puede ser compartido por aseos, baños, cocinas y trasteros.
- Los conductos deben ser estancos al aire para su presión de dimensionado, deben tener un acabado que dificulte su ensuciamiento y ser practicables para su registro y limpieza en la coronación.

Tipo de vivienda	Caudal mínimo $q_v$ en l/s				
	Locales secos <sup>(1)</sup> <sup>(2)</sup>			Locales húmedos <sup>(2)</sup>	
	Dormitorio principal	Resto de dormitorios	Salas de estar y comedores	Mínimo en total	Mínimo por local
0 ó 1 dormitorios	8	-	6	12	6
2 dormitorios	8	4	8	24	7
3 o más dormitorios	8	4	10	33	8

<sup>(1)</sup> En los locales secos de las viviendas destinados a varios usos se considera el caudal correspondiente al uso para el que resulte un mayor caudal.

<sup>(2)</sup> Cuando en un mismo local se den usos de local seco y húmedo, cada zona debe dotarse de su caudal correspondiente

<sup>(3)</sup> Otros locales pertenecientes a la vivienda con usos similares (salas de juego, despachos, etc.)

Adicionalmente, las cocinas deben disponer de un sistema adicional específico de ventilación con extracción mecánica para los vapores y los contaminantes de la cocción. Cuando este conducto sea colectivo, cada extractor debe conectarse al mismo mediante un ramal que debe desembocar en el conducto de extracción inmediatamente por debajo del ramal siguiente.

Por otra parte, el Real Decreto 235/2013 del 5 de abril, establece la obligatoriedad de la certificación energética de cualquier edificio que se venda o alquile a un nuevo arrendatario. Esta valoración se basa en el análisis, reglas y procedimientos exigidas por el Documento Básico HE (Ahorro de energía) del CTE.

Dentro de todos los aspectos que se contemplan en esta certificación, la ventilación mecánica de las viviendas tiene un peso muy importante, afectando a gran medida a la certificación final del edificio.

En particular, los Sistemas de doble flujo son un aspecto fundamental para garantizar una buena Calificación energética del edificio, ya que al recuperar hasta un 90% del calor de la vivienda, se convierten en la mejor opción a nivel de eficiencia energética.

# Tablas de selección rápida para **VENTILACIÓN SIMPLE FLUJO**

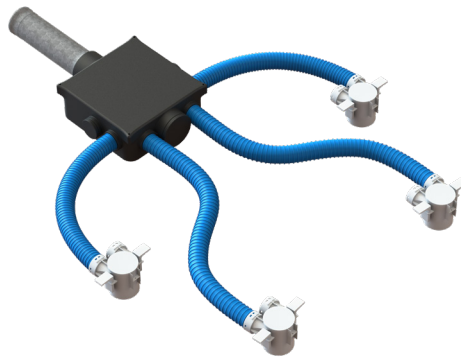

## SISTEMA INDIVIDUAL

CAUDALES Y DIÁMETROS POR VIVIENDA SEGÚN CTE 2017

TIPOLOGÍA	LOCALES HÚMEDOS					Q total VIVIENDA (m³/h)	Ø Mínimo Teórico (mm)	Ø SVCH (mm)
	COCINA	*BAÑO 1	*BAÑO 2	*BAÑO 3	*BAÑO 4			
0D + 1B	30	30				60	Ø73	Ø80
1D + 1B	30	30				60	Ø73	Ø80
1D + 2B	30	30	30			90	Ø89	Ø100
2D + 1B	45	45				90	Ø89	Ø100
2D + 2B	30	30	30			90	Ø89	Ø100
2D + 3B	30	30	30	30		120	Ø103	Ø110
3D + 1B	60	60				120	Ø103	Ø110
3D + 2B	45	45	30			120	Ø103	Ø110
3D + 3B	30	30	30	30		120	Ø103	Ø110
3D + 4B	30	30	30	30	30	150	Ø115	Ø130
4D + 2B	45	45	30			120	Ø103	Ø110
4D + 3B	30	30	30	30		120	Ø103	Ø110
4D + 4B	30	30	30	30	30	150	Ø115	Ø130

\* Baño o local en el que existen aparatos que consumen agua, alimentados por las derivaciones de aparato de la instalación interior particular.

## SISTEMA COLECTIVO

### ACCESORIOS PARA VENTILACIÓN SIMPLE FLUJO COLECTIVA

<b>Q total por vertical ≤ 190m³/h → Ø130</b>	<b>Q total por vertical L ≤ 256m³/h → Ø150</b>
Inline 150	Inline 150
Silenciador JS 125-600	Silenciador JS 150-600
<b>Q total por vertical ≤ 368m³/h → Ø180</b>	<b>Q total por vertical ≤ 454m³/h → Ø200</b>
Inline 150	Inline 200
Silenciador JS 150-600	Silenciador JS 200-600
<b>Q total por vertical ≤ 709m³/h → Ø250</b>	<b>Q total por vertical ≤ 1020m³/h → Ø300</b>
Inline 200	Inline 250
Silenciador JS 200-600	Silenciador JS 250-600
<b>Q total por vertical ≤ 1386m³/h → Ø350</b>	<b>Q total por vertical ≤ 1800m³/h → Ø400</b>
A consultar	A consultar
A consultar	A consultar

\* Pérdida de carga estimada entre 50 Pa y 150 Pa

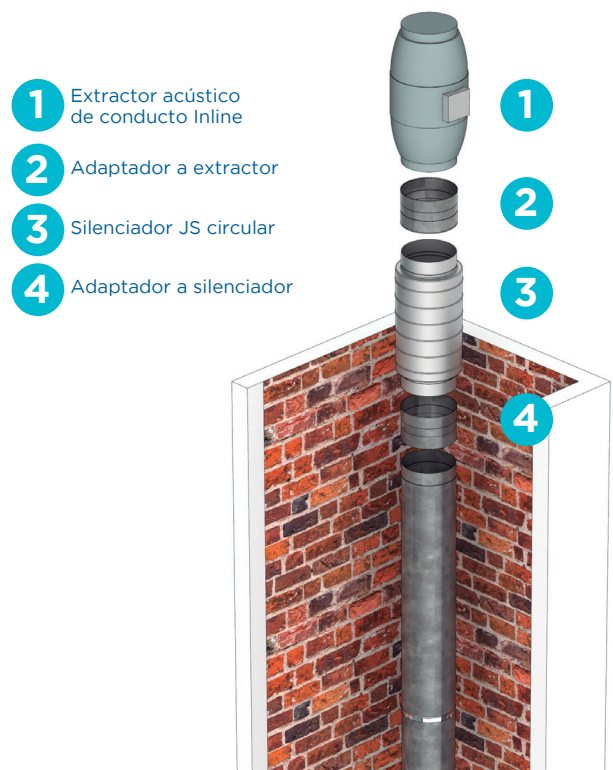

# Tablas de selección rápida para **VENTILACIÓN DOBLE FLUJO**

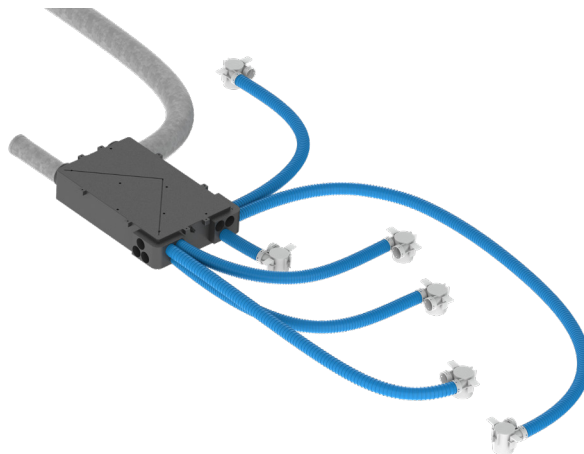

DOBLE FLUJO EKKOAIR: EXTRACCIÓN/IMPULSIÓN COMPENSADO POR VIVIENDA

TIPOLOGÍA	EXTRACCIÓN					Q total vivienda	IMPULSIÓN				
	COCINA	*BAÑO 1	*BAÑO 2	*BAÑO 3	*BAÑO 4		SALÓN	DOR. PPAL	D1	D2	D3
0D + 1LH	30	30				60	60				
1D + 1LH	30	30				60	30	30			
1D + 2LH	30	30	30			90	45	45			
2D + 1LH	45	45				90	45	30	15		
2D + 2LH	30	30	30			90	45	30	15		
2D + 3LH	30	30	30	30		120	45	45	30		
3D + 1LH	60	60				120	45	30	30	15	
3D + 2LH	45	45	30			120	45	30	30	15	
3D + 3LH	30	30	30	30		120	45	30	30	15	
4D + 2LH	45	45	30			120	45	30	15	15	15
4D + 3LH	30	30	30	30		120	45	30	15	15	15
3D + 4LH	30	30	30	30	30	150	45	45	30	30	
4D + 4LH	30	30	30	30	30	150	45	30	30	30	15

\* Baño o local en el que existen aparatos que consumen agua, alimentados por las derivaciones de aparato de la instalación interior particular.



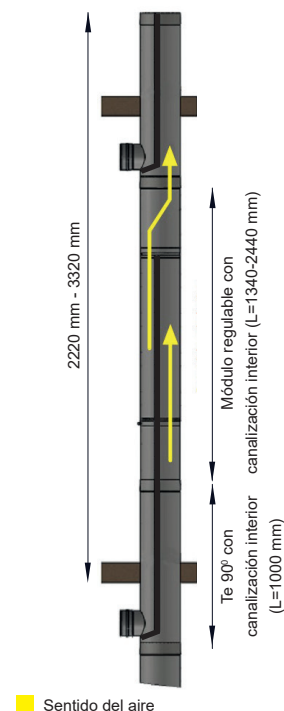

## Tablas selección rápida **CAMPANAS**

SVC PARA EXTRACCIÓN DE CAMPANAS DE COCINA			
1 CAMPANA POR PLANTA		2 CAMPANA POR PLANTA	
Nº PLANTAS	DIÁMETRO (mm)	Nº PLANTAS	DIÁMETRO (mm)
1	130	1	180
2	180	2	250
3	250	3	350
4	250	4	350
5	300	5	400
6	350	6	450
7	350	7	500
8	350	8	500
9	400	9	550
10	400	10	600

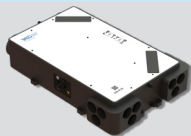
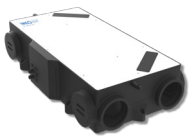
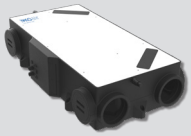

# RECUPERADORES











## RECUPERADORES DE CALOR INDIVIDUALES

PRODUCTO	REF.	DESCRIPCIÓN ARTÍCULO	PVP
 <b>GENIUS 200</b>	403-COVE79N0001	Recuperador de calor GENIUS con mando	2497€
	403-COVE187N0001	Recuperador entálpico GENIUS-e con mando	2846€
 <b>GENIUS 350</b>	403-COVE00738	Recuperador de calor GENIUS 350 con mando	3383€
	403-COVE00739	Recuperador de calor GENIUS-e 350 con mando	3620€
 <b>GENIUS 450</b>	403-COVE00740	Recuperador de calor GENIUS 450 con mando	3461€
	403-COVE00741	Recuperador de calor GENIUS-e 450 con mando	3699€
 <b>LOGIC 200</b>	403-COVE80N0001	Recuperador de calor LOGIC con mando	2185€
 <b>HOUSE 300</b>	403-COVE00734	Recuperador de calor HOUSE 300 con mando	3160€
	403-COVE00735	Recuperador de calor HOUSE-e 300 con mando	3301€
 <b>HOUSE 300s</b>	403-COVE00732	Recuperador de calor HOUSE 300s con mando	2341€
	403-COVE00733	Recuperador de calor HOUSE-e 300s con mando	2482€
 <b>HOUSE 500</b>	403-COVE00736	Recuperador de calor HOUSE 500 con mando	4004€
	403-COVE00737	Recuperador de calor HOUSE-E 500 con mando	4330€









## RECUPERADORES DE CALOR CORE

PRODUCTO	REF.	DESCRIPCIÓN ARTÍCULO	PVP	
	<b>Core 300</b>	403-COVE230N0001	Recuperador de calor Core 300	8694€
	<b>Core 500</b>	403-COVE230N0002	Recuperador de calor Core 500	10246€
	<b>Core 1000</b>	403-COVE230N0003	Recuperador de calor Core 1000	17193€



## ACCESORIOS GENIUS/LOGIC/HOUSE

PRODUCTO	REF.	DESCRIPCIÓN ARTÍCULO	PVP	
	Esquina 6xØ75	403-COVE100N0001	Esquina conexión 6xØ75	29.71€
	Esquina 1xØ160	403-COVE100N0002	Esquina conexión 1xØ160	29.71€
	Soportes GENIUS/LOGIC	000-DRWG107N0001	Soportes para recuperador GENIUS/LOGIC	29.71€
	Filtro M5 Genius/Logic	403-COVE100N0003	Bolsa de 2 Filtros M5 Gen/Log Coarse 90% ISO 16890	82€
	Filtro F7 Genius/Logic	403-COVE100N0004	Bolsa de 2 Filtros F7 Gen/Log ePM1 50 % ISO 16890	88€
	Filtro F9 Genius/Logic	403-COVE232N0001	Bolsa de 2 Filtros F9 Gen/Log ePM1 80 % ISO 16890	101€
	Filtro M5 Genius 350/450	403-COVE00533	Bolsa de 2 Filtros M5 Genius 350/450 ePM10 55%	88€
	Filtro F7 Genius 350/450	403-COVE00515	Bolsa de 2 Filtros F7 Genius 350/450 ePM1 70%	97€
	Filtro F9 Genius 350/450	403-COVE00504	Bolsa de 2 Filtros F9 Genius 350/450 ePM1 85%	126€
	Filtros G4/Carbón Activo Genius 350/450	403-COVE00511	Bolsa de 2 Filtros G4/Carbón Activo Genius 350/450	101€
	Filtro M5 House 300	403-COVE00526	Bolsa de 2 Filtros M5 House 300 ePM10 55%	96€
	Filtro F7 House 300	403-COVE00561	Bolsa de 2 Filtros F7 House 300 ePM1 70%	106€
	Filtro F9 House 300	403-COVE00488	Bolsa de 2 Filtros F9 House 300 ePM1 85%	141€
	Filtros G4/Carbón Activo House 300	403-COVE00524	Bolsa de 2 Filtros G4/Carbón Activo House 300	110€
	Filtro M5 House 500	403-COVE00498	Bolsa de 2 Filtros M5 House 500 ePM10 55%	119€
	Filtro F7 House 500	403-COVE00568	Bolsa de 2 Filtros F7 House 500 ePM1 70%	135€
	Filtro F9 House 500	403-COVE00495	Bolsa de 2 Filtros F9 House 500 ePM1 85%	185€
	Filtros G4/Carbón Activo House 500	403-COVE00492	Bolsa de 2 Filtros G4/Carbón Activo House 500	136€
	Módulo wifi	403-COVE100N0011	Módulo Wifi	638€
	Post-calentador GENIUS/LOGIC	403-COVE100N0006	Post-calentador Ø160 de 0,6kW (1fase)	1039€
		403-COVE00585	Post-calentador Ø200 de 1,2kW (1fase)	1323€
	Pre-calentador GENIUS/LOGIC	403-COVE100N0005	Pre-calentador Ø160 de 0,6kW (1fase)	419€
		403-COVE00516	Pre-calentador Ø200 de 1,2kW (1fase)	474€
		403-COVE00555	Pre-calentador Ø160 de 0,9kW (1fase)	399€
	Sensor externo CO2	403-COVE100N0013	Sensor Externo de CO2	440€
		403-COVE00591	Sensor para conducto de CO2	604€
	Sensor externo de Radón	403-COVE00527	Sensor externo de Radón	2037€

## Accesorios recuperadores

	<b>Sensor externo de Humedad Relativa HR</b>	403-COVE100N0014	Sensor Externo de Humedad Relativa HR	240€
	<b>Sensor para conducto de Humedad Relativa HR</b>	403-COVE00531	Sensor para conducto de Humedad Relativa HR	384€
	<b>Sensor externo de CO2+HR</b>	403-COVE100N0015	Sensor externo de CO2+HR	563€
	<b>Módulo de conexión hasta 8 sensores</b>	403-COVE100N0016	Módulo de Conexión hasta 8 Sensores	48.41€
	<b>Sifón válvula condensador</b>	403-COVE103N0001	Sifón válvula condensados 16/20/25mm	46.86€
	<b>Reducción hembra Ø160 a macho Ø125 con junta</b>	400-HELI6501600125	Reducción hembra Ø160 a macho Ø125 con junta	15.91€
	<b>Reducción hembra Ø160 a macho Ø150 con junta</b>	400-HELI6501600150	Reducción hembra Ø160 a macho Ø150 con junta	15.91€
	<b>Adaptador Genius/Logic/Jet</b>	684-SVCH2690100	Adaptador Genius/Logic/Jet a SVCH 100	14.85€
		684-SVCH2690110	Adaptador Genius/Logic/Jet a SVCH 110	15.91€
		684-SVCH2690150	Adaptador Genius/Logic/Jet a SVCH 150	16.97€
		000-DRWG2680100	Adaptador Genius/Logic/Jet a PVC 100	14.85€
		000-DRWG2680125	Adaptador Genius/Logic/Jet a PVC 125	15.91€
		000-DRWG2680150	Adaptador Genius/Logic/Jet a PVC 150	16.97€
	<b>Core básico</b>	403-COVE231N0001	Control Core básico	229€
	<b>Core básico wifi</b>	403-COVE231N0002	Control Core básico wifi	252€
	<b>Core display</b>	403-COVE231N0003	Control Core display	435€
	<b>Unidad externa CWC 125</b>	403-COVE193N0001	Unidad externa de calor/frío por agua CWC-125	996€
	<b>Unidad externa CWC 160</b>	403-COVE194N0001	Unidad externa de calor/frío por agua CWC-160	1028€
	<b>Unidad externa CWC 200</b>	403-COVE00542	Unidad externa de calor/frío por agua CWC-200	1049€

## RECUPERADORES DESCENTRALIZADOS

PRODUCTO	REF.	DESCRIPCIÓN ARTÍCULO	PVP	
	<b>DVT 100</b>	403-COVE00954	Recuperador descentralizado DVT 100	529€
	<b>DVTR 100 con mando</b>	403-COVE00955	Recuperador descentralizado DVTR 100 con mando	560€
	<b>DVT 125</b>	403-COVE00956	Recuperador descentralizado DVT 125	590€
	<b>DVTR 125 con mando</b>	403-COVE00957	Recuperador descentralizado DVTR 125 con mando	618€
	<b>VDCS 160 con mando</b>	403-COVE00958	Recuperador descentralizado VDCS 160 con mando	1308€
	<b>VDCP 160 con mando</b>	403-COVE00959	Recuperador descentralizado VDCP 160 con mando	1694€

## ACCESORIOS

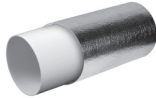
PRODUCTO	REF.	DESCRIPCIÓN ARTÍCULO	PVP	
	<b>Sensor de temperatura y humedad para VDCS</b>	403-COVE00960	Sensor de temperatura y humedad para VDCS	130
	<b>Filtro para VDC</b>	403-COVE00961	Filtro para recuperador descentralizado VDC	17€
	<b>Conducto aislado VDC</b>	403-COVE00962	Conducto aislado para recuperador VDC L=750 mm	65€
	<b>Panel exterior metálico para VDC blanco</b>	403-COVE00963	Panel exterior metálico para VDC blanco	111€
	<b>Panel exterior metálico para VDC grafito</b>	403-COVE00964	Panel exterior metálico para VDC grafito	111€

## RECUPERADORES DE CALOR CENTRALIZADOS JRC



	VERSIÓN HORIZONTAL				VERSIÓN VERTICAL			
<b>JRC 650</b>	JRCH 650 CA con mando		JRCH 650 CB con mando		JRCV 650 CA con mando		JRCV 650 CB con mando	
	403-COVE00692	4193€	403-COVE00712	4193€	403-COVE00702	4409€	403-COVE00722	4409€
<b>Accesorios</b>	<b>Referencia</b>	<b>Descripción</b>	<b>PVP</b>	<b>Referencia</b>	<b>Descripción</b>	<b>PVP</b>		
	403-COVE00773	Tejadillo para JRCH 650	101€	403-COVE00783	Tejadillo para JRCV 650	72€		
	<b>Referencia</b>	<b>Descripción</b>	<b>PVP</b>					
	403-COVE00611	Filtro G4 para extracción JRC 650	29.87€					
	403-COVE00621	Filtro F6 para extracción JRC 650	40.17€					
	403-COVE00631	Filtro F7 para impulsión JRC 650	43.26€					
	403-COVE00641	Filtro F6+F8 para impulsión JRC 650	87€					
	403-COVE00651	Filtro F7+F9 para impulsión JRC 650	84€					
	403-COVE00662	Batería para agua fría para JRC 650	1197€					
	403-COVE00672	Batería para agua caliente para JRC 650	1136€					
403-COVE00793	Visera para JRC 650	115€						
<b>JRC 1000</b>	JRCH 1000 CA con mando		JRCH 1000 CB con mando		JRCV 1000 CA con mando		JRCV 1000 CB con mando	
	403-COVE00693	5083€	403-COVE00713	5083€	403-COVE00703	5347€	403-COVE00723	5347€
<b>Accesorios</b>	<b>Referencia</b>	<b>Descripción</b>	<b>PVP</b>	<b>Referencia</b>	<b>Descripción</b>	<b>PVP</b>		
	403-COVE00774	Tejadillo para JRCH 1000	134€	403-COVE00784	Tejadillo para JRCV 1000	94€		
	<b>Referencia</b>	<b>Descripción</b>	<b>PVP</b>					
	403-COVE00612	Filtro G4 para extracción JRC 1000	36.05€					
	403-COVE00622	Filtro F6 para extracción JRC 1000	62€					
	403-COVE00632	Filtro F7 para impulsión JRC 1000	62€					
	403-COVE00642	Filtro F6+F8 para impulsión JRC 1000	127€					
	403-COVE00652	Filtro F7+F9 para impulsión JRC 1000	127€					
	403-COVE00663	Batería para agua fría para JRC 1000	1269€					
	403-COVE00673	Batería para agua caliente para JRC 1000	1208€					
403-COVE00794	Visera para JRC 1000	119€						
<b>JRC 1800</b>	JRCH 1800 CA con mando		JRCH 1800 CB con mando		JRCV 1800 CA con mando		JRCV 1800 CB con mando	
	403-COVE00694	7917€	403-COVE00714	7917€	403-COVE00704	8328€	403-COVE00724	8328€
<b>Accesorios</b>	<b>Referencia</b>	<b>Descripción</b>	<b>PVP</b>	<b>Referencia</b>	<b>Descripción</b>	<b>PVP</b>		
	403-COVE00775	Tejadillo para JRCH 1800	159€	403-COVE00785	Tejadillo para JRCV 1800	127€		
	<b>Referencia</b>	<b>Descripción</b>	<b>PVP</b>					
	403-COVE00613	Filtro G4 para extracción JRC 1800	40.17€					
	403-COVE00623	Filtro F6 para extracción JRC 1800	79€					
	403-COVE00633	Filtro F7 para impulsión JRC 1800	79€					
	403-COVE00643	Filtro F6+F8 para impulsión JRC 1800	166€					
	403-COVE00653	Filtro F7+F9 para impulsión JRC 1800	170€					
	403-COVE00664	Batería para agua fría para JRC 1800	1759€					
	403-COVE00674	Batería para agua caliente para JRC 1800	1670€					
403-COVE00795	Visera para JRC 1800	134€						



	VERSIÓN HORIZONTAL				VERSIÓN VERTICAL			
<b>JRC 2300</b>	JRCH 2300 CA con mando		JRCH 2300 CB con mando		JRCV 2300 CA con mando		JRCV 2300 CB con mando	
	403-COVE00695	8400€	403-COVE00715	8400€	403-COVE00705	8832€	403-COVE00725	8832€
Accesorios	<b>Referencia</b>	<b>Descripción</b>	<b>PVP</b>	<b>Referencia</b>	<b>Descripción</b>	<b>PVP</b>		
	403-COVE00776	Tejadillo para JRCH 2300	177€	403-COVE00786	Tejadillo para JRCV 2300	127€		
	<b>Referencia</b>	<b>Descripción</b>	<b>PVP</b>					
	403-COVE00614	Filtro G4 para extracción JRC 2300				47.38€		
	403-COVE00624	Filtro F6 para extracción JRC 2300				83€		
	403-COVE00634	Filtro F7 para impulsión JRC 2300				83€		
	403-COVE00644	Filtro F6+F8 para impulsión JRC 2300				177€		
	403-COVE00654	Filtro F7+F9 para impulsión JRC 2300				177€		
	403-COVE00665	Batería para agua fría para JRC 2300				1759€		
	403-COVE00675	Batería para agua caliente para JRC 2300				1670€		
403-COVE00796	Visera para JRC 2300				134€			
<b>JRC 3500</b>	JRCH 3500 CA con mando		JRCH 3500 CB con mando		JRCV 3500 CA con mando		JRCV 3500 CB con mando	
	403-COVE00696	9445€	403-COVE00716	9445€	403-COVE00706	9935€	403-COVE00726	9935€
Accesorios	<b>Referencia</b>	<b>Descripción</b>	<b>PVP</b>	<b>Referencia</b>	<b>Descripción</b>	<b>PVP</b>		
	403-COVE00777	Tejadillo para JRCH 3500	235€	403-COVE00787	Tejadillo para JRCV 650	173€		
	<b>Referencia</b>	<b>Descripción</b>	<b>PVP</b>					
	403-COVE00615	Filtro G4 para extracción JRC 3500				55€		
	403-COVE00625	Filtro F6 para extracción JRC 3500				105€		
	403-COVE00635	Filtro F7 para impulsión JRC 3500				105€		
	403-COVE00645	Filtro F6+F8 para impulsión JRC 3500				220€		
	403-COVE00655	Filtro F7+F9 para impulsión JRC 3500				224€		
	403-COVE00666	Batería para agua fría para JRC 3500				3144€		
	403-COVE00676	Batería para agua caliente para JRC 3500				2985€		
403-COVE00797	Visera para JRC 3500				144€			
<b>JRC 4800</b>	JRCH 4800 CA con mando		JRCH 4800 CB con mando		JRCV 4800 CA con mando		JRCV 4800 CB con mando	
	403-COVE00697	11594€	403-COVE00717	11594€	403-COVE00707	12192€	403-COVE00727	12192€
Accesorios	<b>Referencia</b>	<b>Descripción</b>	<b>PVP</b>	<b>Referencia</b>	<b>Descripción</b>	<b>PVP</b>		
	403-COVE00778	Tejadillo para JRCH 4800	274€	403-COVE00788	Tejadillo para JRCV 4800	192€		
	<b>Referencia</b>	<b>Descripción</b>	<b>PVP</b>					
	403-COVE00616	Filtro G4 para extracción JRC 4800				58€		
	403-COVE00626	Filtro F6 para extracción JRC 4800				127€		
	403-COVE00636	Filtro F7 para impulsión JRC 4800				130€		
	403-COVE00646	Filtro F6+F8 para impulsión JRC 4800				264€		
	403-COVE00656	Filtro F7+F9 para impulsión JRC 4800				267€		
	403-COVE00667	Batería para agua fría para JRC 4800				3807€		
	403-COVE00677	Batería para agua caliente para JRC 4800				4723€		
403-COVE00798	Visera para JRC 4800				170€			
<b>JRC 6000</b>	JRCH 6000 CA con mando		JRCH 6000 CB con mando		JRCV 6000 CA con mando		JRCV 6000 CB con mando	
	403-COVE00698	13076€	403-COVE00718	13076€	403-COVE00708	13764€	403-COVE00728	13764€
Accesorios	<b>Referencia</b>	<b>Descripción</b>	<b>PVP</b>	<b>Referencia</b>	<b>Descripción</b>	<b>PVP</b>		
	403-COVE00779	Tejadillo para JRCH 6000	321€	403-COVE00789	Tejadillo para JRCV 6000	216€		
	<b>Referencia</b>	<b>Descripción</b>	<b>PVP</b>					
	403-COVE00617	Filtro G4 para extracción JRC 6000				184€		
	403-COVE00627	Filtro F6 para extracción JRC 6000				199€		
	403-COVE006377	Filtro F7 para impulsión JRC 6000				278€		
	403-COVE00647	Filtro F6+F8 para impulsión JRC 6000				530€		
	403-COVE00657	Filtro F7+F9 para impulsión JRC 6000				588€		
	403-COVE00668	Batería para agua fría para JRC 6000				4518€		
	403-COVE00678	Batería para agua caliente para JRC 6000				3879€		
403-COVE00799	Visera para JRC 6000				184€			

JRC 7400	JRCH 7400 CA con mando		JRCH 7400 CB con mando		JRCV 7400 CA con mando		JRCV 7400 CB con mando	
	403-COVE00699	17729€	403-COVE00719	17729€	403-COVE00709	18678€	403-COVE00729	18678€
Accesorios	Referencia	Descripción	PVP	Referencia	Descripción	PVP		
	403-COVE00780	Tejadillo para JRCH 7400	361€	403-COVE00790	Tejadillo para JRCV 7400	274€		
	Referencia	Descripción	PVP					
	403-COVE00618	Filtro G4 para extracción JRC 7400	216€					
	403-COVE00628	Filtro F6 para extracción JRC 7400	274€					
	403-COVE00638	Filtro F7 para impulsión JRC 7400	430€					
	403-COVE00648	Filtro F6+F8 para impulsión JRC 7400	923€					
	403-COVE00658	Filtro F7+F9 para impulsión JRC 7400	1074€					
	403-COVE00669	Batería para agua fría para JRC 7400	4518€					
	403-COVE00679	Batería para agua caliente para JRC 7400	4290€					
403-COVE00800	Visera para JRC 7400	216€						
JRC 9500	JRCH 9500 CA con mando		JRCH 9500 CB con mando		JRCV 9500 CA con mando		JRCV 9500 CB con mando	
403-COVE00700	22575€	403-COVE00720	22575€	403-COVE00710	23775€	403-COVE00730	23775€	
Accesorios	Referencia	Descripción	PVP	Referencia	Descripción	PVP		
	403-COVE00781	Tejadillo para JRCH 9500	444€	403-COVE00791	Tejadillo para JRCV 9500	321€		
	Referencia	Descripción	PVP					
	403-COVE00619	Filtro G4 para extracción JRC 9500	386€					
	403-COVE00629	Filtro F6 para extracción JRC 9500	422€					
	403-COVE00639	Filtro F7 para impulsión JRC 9500	548€					
	403-COVE00649	Filtro F6+F8 para impulsión JRC 9500	995€					
	403-COVE00659	Filtro F7+F9 para impulsión JRC 9500	1060€					
	403-COVE00670	Batería para agua fría para JRC 9500	4640€					
	403-COVE00680	Batería para agua caliente para JRC 9500	4409€					
403-COVE00801	Visera para JRC 9500	216€						
JRC 10800	JRCH 10800 CA con mando		JRCH 10800 CB con mando		JRCV 10800 CA con mando		JRCV 10800 CB con mando	
403-COVE00701	24511€	403-COVE00721	24511€	403-COVE00711	25816€	403-COVE00731	25816€	
Accesorios	Referencia	Descripción	PVP	Referencia	Descripción	PVP		
	403-COVE00782	Tejadillo para JRCH 10800	534€	403-COVE00792	Tejadillo para JRCV 10800	375€		
	Referencia	Descripción	PVP					
	403-COVE00620	Filtro G4 para extracción JRC 10800	433€					
	403-COVE00630	Filtro F6 para extracción JRC 10800	545€					
	403-COVE00640	Filtro F7 para impulsión JRC 10800	555€					
	403-COVE00650	Filtro F6+F8 para impulsión JRC 10800	1064€					
	403-COVE00660	Filtro F7+F9 para impulsión JRC 10800	1175€					
	403-COVE00671	Batería para agua fría para JRC 10800	4640€					
	403-COVE00681	Batería para agua caliente para JRC 10800	4409€					
403-COVE00802	Visera para JRC 10800	256€						

## ACCESORIOS COMUNES JRC

PRODUCTO	REF.	DESCRIPCIÓN ARTÍCULO	PVP
	403-COVE00606	Sonda CO2 de conducto para JRC	683€
	403-COVE00607	Sonda CO2 de ambiente para JRC	620€
	403-COVE00608	Sonda HR de ambiente para JRC	683€
	403-COVE00609	Sonda diferencial de presión para JRC 0-500Pa	354€
	403-COVE00610	Sonda diferencial de presión para JRC 0-1.000Pa	354€
	403-COVE00682	Resistencia eléctrica para JRC de 4 kw (3 etapas)	3079€
	403-COVE00683	Resistencia eléctrica para JRC de 6 kw (3 etapas)	3223€
	403-COVE00684	Resistencia eléctrica para JRC de 9 kw (3 etapas)	3339€
	403-COVE00685	Resistencia eléctrica para JRC de 12 kw (3 etapas)	3439€
	403-COVE00686	Resistencia eléctrica para JRC de 15 kw (3 etapas)	4521€
	403-COVE00687	Resistencia eléctrica para JRC de 17 kw (3 etapas)	4953€
	403-COVE00688	Resistencia eléctrica para JRC de 20 kw (3 etapas)	5386€

## EXTRACTORES

PRODUCTO	REF.	DESCRIPCIÓN ARTÍCULO	PVP
 JET SLIM	403-COVE304N0001	Extractor Jet Slim	286€
 JET SLIM EC	403-COVE301N0001	Extractor Jet Slim EC	334€

### Accesorios Jet

PRODUCTO	REF.	DESCRIPCIÓN ARTÍCULO	PVP	
 Mando RF 3 velocidades JET	403-COVE100N0020	Mando inalámbrico de 3 velocidades para Jet	114€	
 Caja de mecanismo de regulador Jet Slim	403-COVE00483	Caja de mecanismo 75X75X60 de regulador Jet Slim	3.09€	
 Regulador 3 velocidades para Jet Slim	403-COVE305N0001	Regulador de 3 velocidades para Jet Slim	64€	
 Regulador de velocidad para Jet Slim EC	403-COVE302N0001	Regulador de velocidad para Jet Slim EC	62€	
	<b>Adaptador a SVCH 100</b>	684-SVCH2690100	Adaptador Genius/Logic/Jet a SVCH 100	14.85€
	<b>Adaptador a SVCH 110</b>	684-SVCH2690110	Adaptador Genius/Logic/Jet a SVCH 110	15.91€
	<b>Adaptador a SVCH 150</b>	684-SVCH2690150	Adaptador Genius/Logic/Jet a SVCH 150	16.97€
	<b>Adaptador a PVC 100</b>	000-DRWG2680100	Adaptador Genius/Logic/Jet a PVC 100	14.85€
	<b>Adaptador a PVC 125</b>	000-DRWG2680125	Adaptador Genius/Logic/Jet a PVC 125	15.91€
	<b>Adaptador a PVC 150</b>	000-DRWG2680150	Adaptador Genius/Logic/Jet a PVC 150	16.97€

## EXTRACTOR ACÚSTICO DE CONDUCTO INLINE

MODELO	REF.	DESCRIPCIÓN ARTÍCULO	PVP
	403-COVE890100	Extractor acústico de conducto Inline 100	412€
	403-COVE890125	Extractor acústico de conducto Inline 125	423€
	403-COVE890150	Extractor acústico de conducto Inline 150	516€
	403-COVE890160	Extractor acústico de conducto Inline 160	522€
	403-COVE890200	Extractor acústico de conducto Inline 200	614€
	403-COVE890250	Extractor acústico de conducto Inline 250	917€
	403-COVE890315	Extractor acústico de conducto Inline 315	1206€

## CAJA DE VENTILACIÓN JVCF-H



CAJAS JVCF-H		
Caja JVCF-H 400°/2h 10/5-0,37 kW-O1	403-COVE00838	2119€
Caja JVCF-H 400°/2h 10/5-0,55 kW-O1	403-COVE00839	2216€
Caja JVCF-H 400°/2h 10/5-0,75 kW-O1	403-COVE00840	2218€
Caja JVCF-H 400°/2h 10/5-1,1 kW-O1	403-COVE00841	2327€
Caja JVCF-H 400°/2h 10/5-1,5 kW-O1	403-COVE00842	2405€
Caja JVCF-H 400°/2h 12/6-0,55 kW-O1	403-COVE00843	2478€
Caja JVCF-H 400°/2h 12/6-0,75 kW-O1	403-COVE00844	2480€
Caja JVCF-H 400°/2h 12/6-1,1 kW-O1	403-COVE00845	2590€
Caja JVCF-H 400°/2h 12/6-1,5 kW-O1	403-COVE00846	2668€
Caja JVCF-H 400°/2h 12/6-2,2 kW-O1	403-COVE00847	2961€
Caja JVCF-H 400°/2h 12/6-3,0 kW-O1	403-COVE00848	3061€
Caja JVCF-H 400°/2h 15/7-0,55 kW-O1	403-COVE00849	2748€
Caja JVCF-H 400°/2h 15/7-0,75 kW-O1	403-COVE00850	2750€
Caja JVCF-H 400°/2h 15/7-1,1 kW-O1	403-COVE00851	2858€
Caja JVCF-H 400°/2h 15/7-1,5 kW-O1	403-COVE00852	2936€
Caja JVCF-H 400°/2h 15/7-2,2 kW-O1	403-COVE00853	3227€
Caja JVCF-H 400°/2h 15/7-3,0 kW-O1	403-COVE00854	3326€
Caja JVCF-H 400°/2h 15/7-4,0 kW-O1	403-COVE00855	3639€
Caja JVCF-H 400°/2h 18/9-0,75 kW-O1	403-COVE00856	2912€
Caja JVCF-H 400°/2h 18/9-1,1 kW-O1	403-COVE00857	3023€
Caja JVCF-H 400°/2h 18/9-1,5 kW-O1	403-COVE00858	3100€
Caja JVCF-H 400°/2h 18/9-2,2 kW-O1	403-COVE00859	3397€
Caja JVCF-H 400°/2h 18/9-3,0 kW-O1	403-COVE00860	3497€
Caja JVCF-H 400°/2h 18/9-4,0 kW-O1	403-COVE00861	3816€
Caja JVCF-H 400°/2h 18/9-5,5 kW-O1	403-COVE00862	4239€
Caja JVCF-H 400°/2h 20/10-1,5 kW-O1	403-COVE00863	5056€

Caja JVCF-H 400°/2h 20/10-2,2 kW-O1	403-COVE00864	5365€
Caja JVCF-H 400°/2h 20/10-3,0 kW-O1	403-COVE00865	5470€
Caja JVCF-H 400°/2h 20/10-4,0 kW-O1	403-COVE00866	5805€
Caja JVCF-H 400°/2h 20/10-5,5 kW-O1	403-COVE00867	6248€
Caja JVCF-H 400°/2h 20/10-7,5 kW-O1	403-COVE00868	6566€
Caja JVCF-H 400°/2h 22/11-2,2 kW-O1	403-COVE00869	5795€
Caja JVCF-H 400°/2h 22/11-3,0 kW-O1	403-COVE00870	5900€
Caja JVCF-H 400°/2h 22/11-4,0 kW-O1	403-COVE00871	6234€
Caja JVCF-H 400°/2h 22/11-5,5 kW-O1	403-COVE00872	6677€
Caja JVCF-H 400°/2h 22/11-7,5 kW-O1	403-COVE00873	6996€
Caja JVCF-H 400°/2h 25/13-11,0 kW-O1	403-COVE00878	8680€
Caja JVCF-H 400°/2h 25/13-3,0 kW-O1	403-COVE00874	6375€
Caja JVCF-H 400°/2h 25/13-4,0 kW-O1	403-COVE00875	6710€
Caja JVCF-H 400°/2h 25/13-5,5 kW-O1	403-COVE00876	7157€
Caja JVCF-H 400°/2h 25/13-7,5 kW-O1	403-COVE00877	7478€
Caja JVCF-H 400°/2h 30/14-11,0 kW-O1	403-COVE00883	9649€
Caja JVCF-H 400°/2h 30/14-15,0 kW-O1	403-COVE00884	10169€
Caja JVCF-H 400°/2h 30/14-3,0 kW-O1	403-COVE00879	7344€
Caja JVCF-H 400°/2h 30/14-4,0 kW-O1	403-COVE00880	7681€
Caja JVCF-H 400°/2h 30/14-5,5 kW-O1	403-COVE00881	8128€
Caja JVCF-H 400°/2h 30/14-7,5 kW-O1	403-COVE00882	8448€
Caja JVCF-H 400°/2h 9/4-0,25 kW-O1	403-COVE00832	2042€
Caja JVCF-H 400°/2h 9/4-0,37 kW-O1	403-COVE00833	2070€
Caja JVCF-H 400°/2h 9/4-0,55 kW-O1	403-COVE00834	2167€
Caja JVCF-H 400°/2h 9/4-0,75 kW-O1	403-COVE00835	2170€
Caja JVCF-H 400°/2h 9/4-1,1 kW-O1	403-COVE00836	2279€
Caja JVCF-H 400°/2h 9/4-1,5 kW-O1	403-COVE00837	2357€

## CAJA DE VENTILACIÓN JVCF-V



### CAJAS JVCF-V

Caja JVCF-V 400°/2h 10/5-0,37 kW-O7	403-COVE00891	2148€
Caja JVCF-V 400°/2h 10/5-0,55 kW-O7	403-COVE00892	2245€
Caja JVCF-V 400°/2h 10/5-0,75 kW-O7	403-COVE00893	2247€
Caja JVCF-V 400°/2h 10/5-1,1 kW-O7	403-COVE00894	2357€
Caja JVCF-V 400°/2h 10/5-1,5 kW-O7	403-COVE00895	2434€
Caja JVCF-V 400°/2h 12/6-0,55 kW-O7	403-COVE00896	2484€
Caja JVCF-V 400°/2h 12/6-0,75 kW-O7	403-COVE00897	2486€
Caja JVCF-V 400°/2h 12/6-1,1 kW-O7	403-COVE00898	2596€
Caja JVCF-V 400°/2h 12/6-1,5 kW-O7	403-COVE00899	2674€
Caja JVCF-V 400°/2h 12/6-2,2 kW-O7	403-COVE00900	2967€
Caja JVCF-V 400°/2h 12/6-3,0 kW-O7	403-COVE00901	3066€
Caja JVCF-V 400°/2h 15/7-0,55 kW-O7	403-COVE00902	2724€
Caja JVCF-V 400°/2h 15/7-0,75 kW-O7	403-COVE00903	2726€
Caja JVCF-V 400°/2h 15/7-1,1 kW-O7	403-COVE00904	2836€
Caja JVCF-V 400°/2h 15/7-1,5 kW-O7	403-COVE00905	2912€
Caja JVCF-V 400°/2h 15/7-2,2 kW-O7	403-COVE00906	3203€
Caja JVCF-V 400°/2h 15/7-3,0 kW-O7	403-COVE00907	3302€
Caja JVCF-V 400°/2h 15/7-4,0 kW-O7	403-COVE00908	3616€
Caja JVCF-V 400°/2h 18/9-0,75 kW-O7	403-COVE00909	2912€
Caja JVCF-V 400°/2h 18/9-1,1 kW-O7	403-COVE00910	3023€
Caja JVCF-V 400°/2h 18/9-1,5 kW-O7	403-COVE00911	3100€
Caja JVCF-V 400°/2h 18/9-2,2 kW-O7	403-COVE00912	3397€
Caja JVCF-V 400°/2h 18/9-3,0 kW-O7	403-COVE00913	3497€
Caja JVCF-V 400°/2h 18/9-4,0 kW-O7	403-COVE00914	3816€
Caja JVCF-V 400°/2h 18/9-5,5 kW-O7	403-COVE00915	4239€
Caja JVCF-V 400°/2h 20/10-1,5 kW-O7	403-COVE00916	5069€

Caja JVCF-V 400°/2h 20/10-2,2 kW-O7	403-COVE00917	5378€
Caja JVCF-V 400°/2h 20/10-3,0 kW-O7	403-COVE00918	5484€
Caja JVCF-V 400°/2h 20/10-4,0 kW-O7	403-COVE00919	5817€
Caja JVCF-V 400°/2h 20/10-5,5 kW-O7	403-COVE00920	6261€
Caja JVCF-V 400°/2h 20/10-7,5 kW-O7	403-COVE00921	6579€
Caja JVCF-V 400°/2h 22/11-2,2 kW-O7	403-COVE00922	6053€
Caja JVCF-V 400°/2h 22/11-3,0 kW-O7	403-COVE00923	6158€
Caja JVCF-V 400°/2h 22/11-4,0 kW-O7	403-COVE00924	6495€
Caja JVCF-V 400°/2h 22/11-5,5 kW-O7	403-COVE00925	6942€
Caja JVCF-V 400°/2h 22/11-7,5 kW-O7	403-COVE00926	7263€
Caja JVCF-V 400°/2h 25/13-11,0 kW-O7	403-COVE00931	8925€
Caja JVCF-V 400°/2h 25/13-3,0 kW-O7	403-COVE00927	6620€
Caja JVCF-V 400°/2h 25/13-4,0 kW-O7	403-COVE00928	6957€
Caja JVCF-V 400°/2h 25/13-5,5 kW-O7	403-COVE00929	7404€
Caja JVCF-V 400°/2h 25/13-7,5 kW-O7	403-COVE00930	7724€
Caja JVCF-V 400°/2h 30/14-11,0 kW-O7	403-COVE00936	9800€
Caja JVCF-V 400°/2h 30/14-15,0 kW-O7	403-COVE00937	10320€
Caja JVCF-V 400°/2h 30/14-3,0 kW-O7	403-COVE00932	7495€
Caja JVCF-V 400°/2h 30/14-4,0 kW-O7	403-COVE00933	7831€
Caja JVCF-V 400°/2h 30/14-5,5 kW-O7	403-COVE00934	8278€
Caja JVCF-V 400°/2h 30/14-7,5 kW-O7	403-COVE00935	8598€
Caja JVCF-V 400°/2h 9/4-0,25 kW-O7	403-COVE00885	2066€
Caja JVCF-V 400°/2h 9/4-0,37 kW-O7	403-COVE00886	2094€
Caja JVCF-V 400°/2h 9/4-0,55 kW-O7	403-COVE00887	2191€
Caja JVCF-V 400°/2h 9/4-0,75 kW-O7	403-COVE00888	2194€
Caja JVCF-V 400°/2h 9/4-1,1 kW-O7	403-COVE00889	2303€
Caja JVCF-V 400°/2h 9/4-1,5 kW-O7	403-COVE00890	2380€

## Cajas de ventilación



## JVCA

Caja de Ventilación JVCA 10000 6P-Trif.	403-COVE264N0001	2106€
Caja de Ventilación JVCA 1700 4P-Monof.	403-COVE264N0002	1097€
Caja de Ventilación JVCA 2400 4P-Monof.	403-COVE264N0003	1170€
Caja de Ventilación JVCA 2900 6P-Monof.	403-COVE264N0004	1400€
Caja de Ventilación JVCA 4200 6P-Monof.	403-COVE264N0005	1319€
Caja de Ventilación JVCA 5300 6P-Monof.	403-COVE264N0006	1580€
Caja de Ventilación JVCA 6000 6P-Monof.	403-COVE264N0007	1612€
Caja de Ventilación JVCA 7000 6P-Trif.	403-COVE264N0008	1685€



## JVCE





Caja de Ventilación JVCE 2300	403-COVE265N0001	2341€
Caja de Ventilación JVCE 3600	403-COVE265N0002	2644€
Caja de Ventilación JVCE 4800	403-COVE265N0003	2839€
Caja de Ventilación JVCE 6000	403-COVE265N0004	3019€
Caja de Ventilación JVCE 6700	403-COVE265N0005	3438€





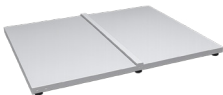





## JVCH

Caja de Ventilación JVCH 2300	403-COVE00760	3480€
Caja de Ventilación JVCH 3600	403-COVE00761	3795€
Caja de Ventilación JVCH 4800	403-COVE00762	3977€
Caja de Ventilación JVCH 6000	403-COVE00763	4178€
Caja de Ventilación JVCH 6700	403-COVE00764	4613€





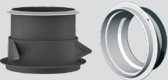
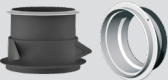

## ACCESORIOS

	PRODUCTO	REF.	DESCRIPCIÓN ARTÍCULO	PVP
	Variador de frecuencia 400V Trifásico 0,75 KW	403-COVE00748	Variador de frecuencia 400V Trifásico 0,75 KW	691€
	Variador de frecuencia 400V Trifásico 1,5 KW	403-COVE00749	Variador de frecuencia 400V Trifásico 1,5 KW	714€
	Variador de frecuencia 400V Trifásico 2,2 KW	403-COVE00750	Variador de frecuencia 400V Trifásico 2,2 KW	761€
	Variador de frecuencia 400V Trifásico 3,7 KW	403-COVE00751	Variador de frecuencia 400V Trifásico 3,7 KW	1040€
	Variador de frecuencia 400V Trifásico 7,5 KW	403-COVE00752	Variador de frecuencia 400V Trifásico 5,5 KW	1296€
	Variador de frecuencia 400V Trifásico 7,5 KW	403-COVE00753	Variador de frecuencia 400V Trifásico 7,5 KW	1576€
	Variador de frecuencia 400V Trifásico 11,0 KW	403-COVE00754	Variador de frecuencia 400V Trifásico 11,0 KW	2057€
	Variador de frecuencia 400V Trifásico 15,0 KW	403-COVE00755	Variador de frecuencia 400V Trifásico 15,0 KW	2398€
	Tejadillo JVC 5/14	403-COVE00808	Tejadillo para caja JVC 5/14	156€
	Tejadillo JVC 7/19	403-COVE00809	Tejadillo para caja JVC 7/19	158€
	Tejadillo JVC 9/25	403-COVE00810	Tejadillo para caja JVC 9/25	167€
	Tejadillo JVC 10/28	403-COVE00811	Tejadillo para caja JVC 10/28	173€
	Tejadillo JVC 12/33	403-COVE00812	Tejadillo para caja JVC 12/33	187€
	Tejadillo JVC 15/39	403-COVE00813	Tejadillo para caja JVC 15/39	201€
	Tejadillo JVC 9/4	403-COVE00814	Tejadillo para caja JVC 9/4	175€
	Tejadillo JVC 10/5	403-COVE00815	Tejadillo para caja JVC 10/5	177€
	Tejadillo JVC 12/6	403-COVE00816	Tejadillo para caja JVC 12/6	190€
	Tejadillo JVC 15/7	403-COVE00817	Tejadillo para caja JVC 15/7	195€
	Tejadillo JVC 18/9	403-COVE00818	Tejadillo para caja JVC 18/9	205€
	Tejadillo JVC 20/10	403-COVE00819	Tejadillo para caja JVC 20/10	221€
	Tejadillo JVC 22/11	403-COVE00820	Tejadillo para caja JVC 22/11	230€
	Tejadillo JVC 25/13	403-COVE00821	Tejadillo para caja JVC 25/13	254€
Tejadillo JVC 30/14	403-COVE00822	Tejadillo para caja JVC 30/14	282€	
	Visera JVCF 9/4	403-COVE00823	Visera impulsión para caja JVCF 9/4	107€
	Visera JVCF 10/5	403-COVE00824	Visera impulsión para caja JVCF 10/5	113€
	Visera JVCF 12/6	403-COVE00825	Visera impulsión para caja JVCF 12/6	117€
	Visera JVCF 15/7	403-COVE00826	Visera impulsión para caja JVCF 15/7	131€
	Visera JVCF 18/9	403-COVE00827	Visera impulsión para caja JVCF 18/9	160€
	Visera JVCF 20/10	403-COVE00828	Visera impulsión para caja JVCF 20/10	171€
	Visera JVCF 22/11	403-COVE00829	Visera impulsión para caja JVCF 22/11	183€
	Visera JVCF 25/13	403-COVE00830	Visera impulsión para caja JVCF 25/13	202€
Visera JVCF 30/14	403-COVE00831	Visera impulsión para caja JVCF 30/14	233€	
	Regulador de velocidad	403-COVE281N0001	Regulador de velocidad REG-3A	155€
		403-COVE281N0002	Regulador de velocidad REG-5A	162€
		403-COVE281N0003	Regulador de velocidad REG-10A	241€
	Potenciometro EC	403-COVE282N0001	Potenciometro para motor EC	137€





# BOCAS DE EXTRACCIÓN/IMPULSIÓN

PRODUCTO	REF.	DESCRIPCIÓN ARTÍCULO	PVP	
	JEH 10/40	403-COVE00214	Boca de extracción higro sin manguito JEH 10/40	62€
	JEH 05/30	403-COVE00743	Boca de extracción higro sin manguito JEH 05/30	70€
	JEH 15/75	403-COVE00744	Boca de extracción higro sin manguito JEH 15/75	89€
	JEH 05/45	403-COVE00745	Boca de extracción higro sin manguito JEH 05/45	62€
	JEH 15/25	403-COVE00746	Boca de extracción higro sin manguito JEH 15/25	70€
	JEH 05/25	403-COVE00747	Boca de extracción higro sin manguito JEH 05/25	70€
	Plenum frontal Ø75	403-COVE00949	Plenum frontal para JRF a Ekkoflex Ø75	72€
	Plenum frontal Ø90	403-COVE00950	Plenum frontal para JRF a Ekkoflex Ø90	77€
	Plenum lateral Ø75	403-COVE00756	Plenum lateral JRF a Ekkoflex Ø75	72€
	Plenum lateral Ø90	403-COVE00757	Plenum lateral JRF a Ekkoflex Ø90	77€
	JRF	403-COVE00742	Boca de extracción/impulsión plana JRF sin plenum	59€
	JTC	403-COVE33N0001	Boca circular PVC con junta JTC 125	30.34€
	JTR	403-COVE35N0001	Boca rectangular PVC con junta JTR 125	26.84€
	JTS	403-COVE2800080	Boca de extracción/impulsión JTS 80 sin manguito	9.27€
	JTS	403-COVE2800125	Boca de extracción/impulsión JTS 125 sin manguito	14.42€
	JE	403-COVE1334N0001	Boca de extracción auto sin manguito JE 15	18.54€
	JE	403-COVE1334N0002	Boca de extracción auto sin manguito JE 30	18.54€
	JE	403-COVE1334N0003	Boca de extracción auto sin manguito JE 45	18.54€
	JE	403-COVE1334N0004	Boca de extracción auto sin manguito JE 60	18.54€
	JE	403-COVE1334N0005	Boca de extracción auto sin manguito JE 90	18.54€
	JEE	403-COVE1334N0006	Boca de extracción/impulsión JEE 80 sin manguito	13.39€
	JEE	403-COVE1334N0007	Boca de extracción/impulsión JEE 125 sin manguito	19.57€
	Manguito pladur JE	403-COVE1334N0011	Manguito pladur para boca JE a Ø80	8.24€
	Manguito pladur JE	403-COVE1334N0008	Manguito pladur para boca JE a Ø100	8.24€
	Manguito pladur JE	403-COVE1334N0009	Manguito pladur para boca JE a Ø125	8.24€
	Manguito JE y JEE	403-COVE1334N0012	Manguito pladur para boca JEE/JTS 80	8.24€
	Manguito JE y JEE	403-COVE1334N0013	Manguito pladur para boca JEE/JTS a Ø80	8.24€
	Manguito JE y JEE	403-COVE1334N0010	Manguito pladur para boca JEE/JTS a Ø125	8.24€
	Manguito pared JE	403-COVE1334N0014	Manguito pared con junta para boca JE a Ø125	7.21€



# REJILLAS

PRODUCTO		REF.	DESCRIPCIÓN ARTÍCULO	PVP
	<b>JGA</b>	403-COVE43N0001	Rejilla de fachada en aluminio Ø160 JGA 160	36.18€
		403-COVE00953	Rejilla de fachada en aluminio Ø200 JGA 200	49.85€
	<b>JGP</b>	403-COVE52N0001	Rejilla de fachada anti-insectos PVC 125 JGP 125	18.67€
		403-COVE53N0001	Rejilla de fachada anti-insectos PVC 150 JGP 150	21.01€
	<b>JG</b>	401-VENTI096N0002	Rejilla autorreg. JG de entrada de aire 22m <sup>3</sup> /h	22.95€
		401-VENTI096N0003	Rejilla autorreg. JG de entrada de aire 30m <sup>3</sup> /h	22.95€
		401-VENTI096N0004	Rejilla autorreg. JG de entrada de aire 45m <sup>3</sup> /h	23.92€
	<b>JGA</b>	401-VENTI097N0001	Rejilla auto JGA ent. aire y ext. acúst. 22m <sup>3</sup> /h	33.34€
		401-VENTI097N0002	Rejilla auto JGA ent. aire y ext. acúst. 30m <sup>3</sup> /h	33.34€
		401-VENTI097N0004	Rejilla auto JGA ent. aire y ext. acúst. 45m <sup>3</sup> /h	34.31€
	<b>JGH</b>	401-VENT00758	Rejilla higo JGH de entrada de aire 5-45 m <sup>3</sup> /h	50€
	<b>JGAH</b>	401-VENT00759	Rejilla higo JGAH ent. aire acústica 5-45 m <sup>3</sup> /h	59€



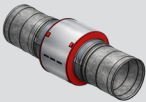

# ATENUADORES ACÚSTICOS

		REF.	DESCRIPCIÓN ARTÍCULO	PVP
	<b>JS-Flex</b>	403-COVE73N0001	Silenciador acústico flexible JS-Flex Ø127	54€
		403-COVE73N0002	Silenciador acústico flexible JS-Flex Ø160	64€
		403-COVE00948	Silenciador acústico flexible JS-Flex Ø203	80€
	<b>JS</b>	401-VENT109306000100	Silenciador circular JS 100-600	111€
		401-VENT109306000125	Silenciador circular JS 125-600	115€
		401-VENT109306000150	Silenciador circular JS 150-600	142€
		401-VENT109306000160	Silenciador circular JS 160-600	145€
		401-VENT109306000180	Silenciador circular JS 180-600	159€
		401-VENT109306000200	Silenciador circular JS 200-600	166€
		401-VENT109306000250	Silenciador circular JS 250-600	204€
		401-VENT109306000300	Silenciador circular JS 300-600	251€
		401-VENT109306000315	Silenciador circular JS 315-600	277€
		401-VENT109303550600	Silenciador circular JS 355-600	313€
		401-VENT109306000400	Silenciador circular JS 400-600	348€
		401-VENT109309000100	Silenciador circular JS 100-900	139€
		401-VENT109309000125	Silenciador circular JS 125-900	152€
		401-VENT109309000150	Silenciador circular JS 150-900	180€
		401-VENT109309000160	Silenciador circular JS 160-900	190€
		401-VENT109309000180	Silenciador circular JS 180-900	207€
		401-VENT109309000200	Silenciador circular JS 200-900	222€
		401-VENT109309000250	Silenciador circular JS 250-900	273€
		401-VENT109309000300	Silenciador circular JS 300-900	334€
		401-VENT109309000315	Silenciador circular JS 315-900	376€
		401-VENT109303550900	Silenciador circular JS 355-900	393€
		401-VENT109309000400	Silenciador circular JS 400-900	489€
			<b>JSN</b>	401-VENT1118N0002
401-VENT1118N0004	Silenciador circular JSN 355-900			897€
401-VENT1118N0006	Silenciador circular JSN 400-900			1061€
401-VENT1118N0008	Silenciador circular JSN 450-900			1171€
401-VENT1118N0010	Silenciador circular JSN 500-900			1278€
401-VENT1118N0012	Silenciador circular JSN 560-900			1555€
401-VENT1118N0014	Silenciador circular JSN 600-900			1679€
401-VENT1118N0001	Silenciador circular JSN 315-1200			1035€
401-VENT1118N0003	Silenciador circular JSN 355-1200			1203€
401-VENT1118N0005	Silenciador circular JSN 400-1200			1371€
401-VENT1118N0007	Silenciador circular JSN 450-1200			1545€
401-VENT1118N0009	Silenciador circular JSN 500-1200			1718€
401-VENT1118N0011	Silenciador circular JSN 560-1200			2177€
401-VENT1118N0013	Silenciador circular JSN 600-1200			2407€
401-VENT1118N0015	Silenciador circular JSN 630-1200			2638€
	<b>JSC</b>	403-COVE6380080	Atenuador acústico de conducto JSC 80	18.73€
		403-COVE6380100	Atenuador acústico de conducto JSC 100	21.86€
		403-COVE6380125	Atenuador acústico de conducto JSC 125	24.98€
	<b>Junta flexible</b>	401-VENT1145N0001	Caja 25ml de junta flex antivibratoria 45/60/45	182€

# REGULACIÓN

PRODUCTO	REF.	DESCRIPCIÓN ARTÍCULO	PVP		
	403-COVE104N0001	Reductor de caudal EkkoFlex Ø75 (Bolsa 10uds)	19.10€		
	403-COVE32140100	Compuerta anti-retorno galvanizada Ø100 con junta	25.46€		
	403-COVE32140125	Compuerta anti-retorno galvanizada Ø125 con junta	27.58€		
	403-COVE32140130	Compuerta anti-retorno galvanizada Ø130 con junta	33.95€		
	403-COVE32140150	Compuerta anti-retorno galvanizada Ø150 con junta	34.97€		
	403-COVE1333N0044	Regulador de caudal JQR 80/15	24.07€		
	403-COVE1333N0045	Regulador de caudal JQR 80/30	24.07€		
	403-COVE1333N0046	Regulador de caudal JQR 80/45	24.07€		
	403-COVE1333N0033	Regulador de caudal JQR 100/15	29.10€		
	403-COVE1333N0034	Regulador de caudal JQR 100/30	29.10€		
	403-COVE1333N0035	Regulador de caudal JQR 100/45	29.10€		
	403-COVE1333N0036	Regulador de caudal JQR 100/60	29.10€		
	403-COVE1333N0037	Regulador de caudal JQR 125/15	33.02€		
	403-COVE1333N0038	Regulador de caudal JQR 125/30	33.02€		
	403-COVE1333N0039	Regulador de caudal JQR 125/45	33.02€		
	403-COVE1333N0040	Regulador de caudal JQR 125/60	33.02€		
	403-COVE1333N0041	Regulador de caudal JQR 150/100	48.99€		
	403-COVE1333N0042	Regulador de caudal JQR 150/120	48.99€		
	403-COVE1333N0043	Regulador de caudal JQR 150/150	48.99€		
		CIV Ø125 a SVCH Ø130	684-SVCH3440130	Manguito intumescente CIV Ø125 a SVCH Ø130	369€
		CIV Ø160 a SVCH Ø150	684-SVCH3440150	Manguito intumescente CIV Ø160 a SVCH Ø150	423€
CIV Ø125 a helicoidal Ø125		000-DRWG3440125	Manguito intumescente CIV Ø125 a helicoidal Ø125	369€	
CIV Ø160 a helicoidal Ø150		000-DRWG3440150	Manguito intumescente CIV Ø160 a helicoidal Ø150	423€	

# SOPORTACIÓN

PRODUCTO	REF.	DESCRIPCIÓN ARTÍCULO	PVP
	665-ZUWA1063DB0080	Abrazadera isofónica M-8 Ø80	4,92€
	665-ZUWA1063DB0100	Abrazadera isofónica M-8 Ø100	5,46€
	665-ZUWA1063DB0110	Abrazadera isofónica M-8 Ø110	5,46€
	665-ZUWA1063DB0125	Abrazadera isofónica M-8 Ø130	6,56€
	665-ZUWA1063DB0130	Abrazadera isofónica M-8 Ø150	6,56€
	665-ZUWA1063DB0150	Abrazadera isofónica M-8 Ø180	11,38€
	AQ4-ZUWA900080	Abrazadera pared regulable galvanizada	18,78 €
	AQ4-ZUWA900100	Abrazadera pared regulable galvanizada	19,71 €
	AQ4-ZUWA900110	Abrazadera pared regulable galvanizada	21,25 €
	AQ4-ZUWA900130	Abrazadera pared regulable galvanizada	21,25 €
	AQ4-ZUWA900150	Abrazadera pared regulable galvanizada	22,20 €
	401-VENT98EMN0001	Soporte AC para abrazadera isofónica	2,81€
	665-ZUWA62DB0080	Abrazadera forjado isofónica galvanizada	18,78 €
	665-ZUWA62DB0100	Abrazadera forjado isofónica galvanizada	19,71 €
	665-ZUWA62DB0125	Abrazadera forjado isofónica galvanizada	21,25 €
	665-ZUWA62DB0130	Abrazadera forjado isofónica galvanizada	21,25 €
	665-ZUWA62DB0150	Abrazadera forjado isofónica galvanizada	22,20 €

# CONDUCTOS PARA VENTILACIÓN

## EKKOFLEX

PRODUCTO	REF.	DESCRIPCIÓN ARTÍCULO	PVP
	Caja de distribución 403-COVE27N0001	Caja de distribución EkkoFlex 125/6X75	188€
	Caja de distribución 403-COVE20N0001	Caja de distribución EkkoFlex 160/6X75	188€
	Codo 90° EkkoFlex 403-COVE920075	Codo 90° EkkoFlex Ø75	31.83€
	Adaptador M-H EkkoFlex 000-DRWG00938	Adaptador M-H EkkoFlex Ø75 a Ø90	9.27€
	Conducto de PVC 403-COVE47N0001	Conducto de PVC Ø125mm de 500 de longitud	10.51€
	Conexión horizontal 403-COVE31N0001	Conexión horizontal EkkoFlex 125/2X75	24.51€
	Conexión vertical corta 403-COVE196N0001	Conexión vertical corta EkkoFlex 125/2X75	23.34€
	Conexión vertical 403-COVE29N0001	Conexión vertical EkkoFlex 125/2X75	30.34€
	Empalme 403-COVE39N0001	Empalme EkkoFlex Ø75mm	4.66€
	Junta 403-COVE48N0001	Junta para EkkoFlex Ø75mm - 5uds	7.01€
	Kit caja de distribución 403-COVE106N0001	Kit caja de distribución EkkoFlex 125/6X75 (Incluidos reductores de caudal)	201€
	Kit caja de distribución 403-COVE105N0001	Kit caja de distribución EkkoFlex 160/6X75 (Incluidos reductores de caudal)	201€
	Kit conexión vertical 403-COVE114N0001	Kit Conexión vertical EkkoFlex 125/2X75	40.84€
	Conducto semirrígido EKKOFLEX 403-COVE406N0001	Rollo 50mts semirrígido EkkoFlex Ø75mm	267€
	403-COVE00485	Rollo 50mts semirrígido EkkoFlex Ø90mm	401€
	Tapa 403-COVE38N0001	Tapa EkkoFlex Ø75mm - 5uds	23.34€
	Cruce EkkoFlex 403-COVE188N0001	Cruce para EkkoFlex Ø75	187€
	Te 90° 403-COVE189N0001	Te 90° Ø125 PVC	15.17€
	Codo 90° 403-COVE190N0001	Codo 90° Ø125 PVC	11.67€
	Caja de distribución 160/8x75 403-COVE155N0001	Caja de distribución vertical EkkoFlex 160/8X75	198€
	Caja de distribución 160/10x75 403-COVE155N0002	Caja de distribución EkkoFlex 160/10X75	339€

## CONDUCTOS FLEXIBLES

PRODUCTO	REF.	DESCRIPCIÓN ARTÍCULO	PVP
 <b>Conducto flexible COMBI JF-PVC</b>	403-COVE71N0001	Conducto flexible COMBI JF-PVC Ø82 (10ml)	23.34€
	403-COVE00947	Conducto flexible COMBI JF-PVC Ø102 (10ml)	26.52€
	403-COVE71N0002	Conducto flexible COMBI JF-PVC Ø127 (10ml)	28.64€
	403-COVE00428	Conducto flexible COMBI JF-PVC Ø140 (10ml)	33.99€
 <b>Conducto flexible JF-ISO</b>	403-COVE75N0001	Conducto flexible aislado JF-ISO Ø160 (10ml)	70€
	403-COVE00946	Conducto flexible aislado JF-ISO Ø203 (10ml)	91€

## ISOLAIR

PRODUCTO	REF.	DESCRIPCIÓN ARTÍCULO	PVP
 <b>Módulo recto Isolair 1.500mm</b>	403-COVE00765	Módulo recto Isolair 1.500mm Ø125	50€
	403-COVE00765	Módulo recto Isolair 1.500mm Ø160	57€
 <b>Codo Isolair 90°</b>	403-COVE00767	Codo Isolair 90° Ø125	22.66€
	403-COVE00768	Codo Isolair 90° Ø160	22.66€
 <b>Codo Isolair 45°</b>	403-COVE00769	Codo Isolair 45° Ø125	28.84€
	403-COVE00770	Codo Isolair 45° Ø160	24.72€
 <b>Manguito Isolair</b>	403-COVE00805	Manguito conexión Isolair Ø125	8.24€
	403-COVE00806	Manguito conexión Isolair Ø160	9.27€

# Ficha Técnica

## SVC-H Campanas

**KKOair**  
by jeremias

Conducto modular metálico de acero galvanizado simple pared, para la extracción de campanas de cocina domésticas.



Ø DISPONIBLES (mm)	Ø 80 a Ø200
MATERIAL	Acero galvanizado/zincado (según diámetro)

### ESPEORES (mm)

0,4- 0,6 (según diámetro)

### SISTEMA DE UNIÓN

Conexión macho-hembra sin **abrazadera de unión**

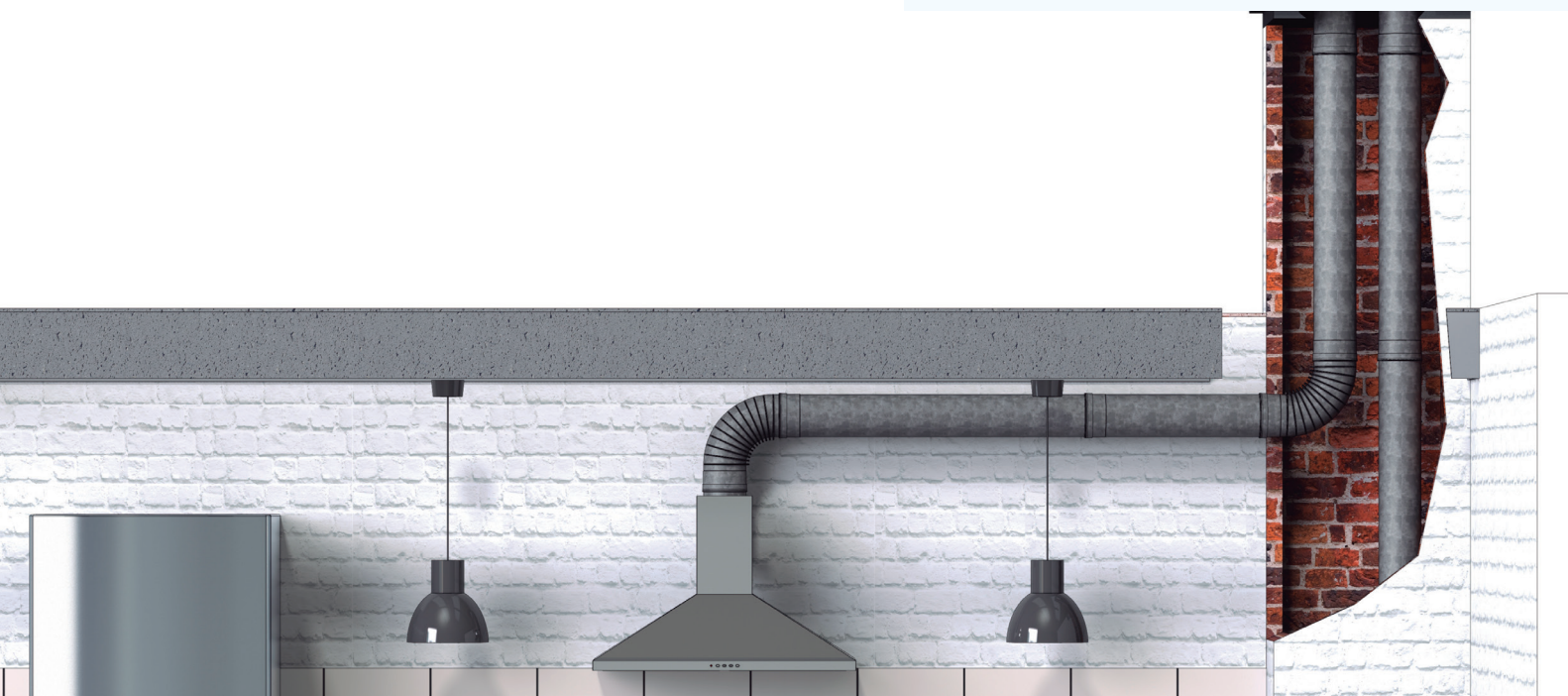

### APLICACIONES

Extracción de campanas domésticas.



### CARACTERÍSTICAS

Cumple con todos los requisitos indicados en CTE  
Garantía de **estanqueidad clase D según norma UNE-EN 12237** sin necesidad de abrazadera de unión  
**Soldadura TIG/LASER** en continuo en todas las piezas  
**Junta incluida.**  
**Conducto cortable.**

### CERTIFICADO

Clase de estanqueidad D según UNE.EN.12237

# Ficha Técnica

## SVC-D

**ekkoair**  
by jeremias

Conducto modular metálico para la extracción de aire viciado e impulsión de aire limpio a la vivienda en doble pared concéntrica sin aislamiento.



Ø DISPONIBLES (mm)    Ø 80 a Ø350

MATERIAL    Pared Interior: Acero Galvanizado  
Pared Intermedio: Acero galvanizado/zincado (según diámetro)

### ESPEORES (mm)

Pared interior: 0,4- 0,6 (según diámetro).  
Pared exterior: 0,4- 0,6 (según diámetro).

### SISTEMA DE UNIÓN

Conexión macho-hembra sin **abrazadera de unión**.

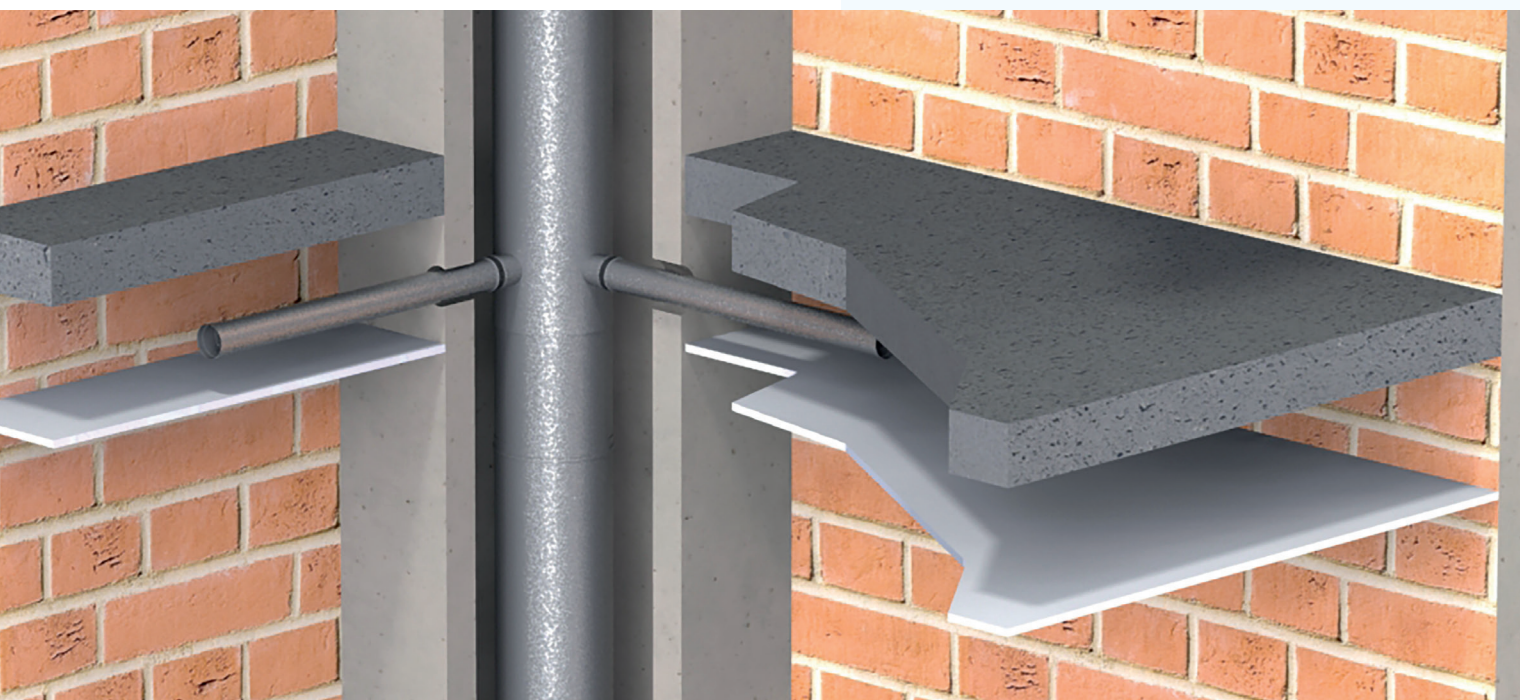

### APLICACIONES

Ventilación mecánica de viviendas.



### CARACTERÍSTICAS

Cumple con todos los requisitos indicados en CTE. Garantía de **estanqueidad clase D según norma UNE-EN 12237** (conexión cónica metal-metal) **sin necesidad de junta** ni abrazadera de unión. **Soldadura TIG/LASER** en continuo en todas las piezas. Instalación con **dos piezas por planta** (Te+regulable).

### CERTIFICADO

Clase de estanqueidad D según UNE.EN.12337

# Ficha Técnica SVC-T

**KKOair**  
by jeremias

Conducto modular metálico para la extracción de aire viciado e impulsión de aire limpio a la vivienda en triple pared con aislamiento.



Ø DISPONIBLES (mm)	Ø 110 a Ø400
MATERIAL	Pared Interior: Acero Galvanizado Pared Intermedio: Acero Galvanizado Pared Exterior: AISI 304

## AISLAMIENTO

Lana de roca rígida de alta densidad (120kg/m<sup>3</sup>)

## ESPESORES (mm)

Pared interior: 0,4- 0,6 (según diámetro)

Aislamiento: 25 mm.

Pared exterior: 0,4- 0,6 (según diámetro)

## SISTEMA DE UNIÓN

Conexión macho-hembra con **abrazadera de unión 2.0**.



## APLICACIONES

Ventilación mecánica de viviendas.



## CARACTERÍSTICAS

Cumple con todos los requisitos indicados en el CTE.  
Garantía de **estanqueidad clase D según norma UNE-EN 12237**.

**Soldadura TIG/LASER** en continuo en todas las piezas.

**Abrazadera de unión 2.0 INCLUIDA.**

**Junta incluida.**

**Conducto cortable.**

## CERTIFICADO

Clase de estanqueidad D según UNE.EN.12337

# Ficha Técnica

## SVC3

ekkoair  
by jeremias

Conducto modular colectivo liso y con soldadura láser para ventilación de viviendas de simple pared.



Ø DISPONIBLES (mm)	Ø 130 a Ø600
MATERIAL	Acero galvanizado / zincado (según diámetros)

### ESPEORES (mm)

0,5 - 0,6 (según diámetro)

### SISTEMA DE UNIÓN

Unión cónica hembra-macho sin **abrazadera de unión**

### CERTIFICADO

Clase de estanqueidad D según UNE.EN.12237

### APLICACIONES

Ventilación mecánica controlada de viviendas.



### CARACTERÍSTICAS

Cumple con todos los requisitos indicados en el CTE.

Garantía de **estanqueidad clase D según norma UNE-EN 12237** (conexión cónica metal-metal) **sin necesidad de junta** ni abrazadera de unión.

**Soldadura TIG/LASER** en continuo en todas las piezas.

Instalación con dos **piezas por planta** (te + regulable).

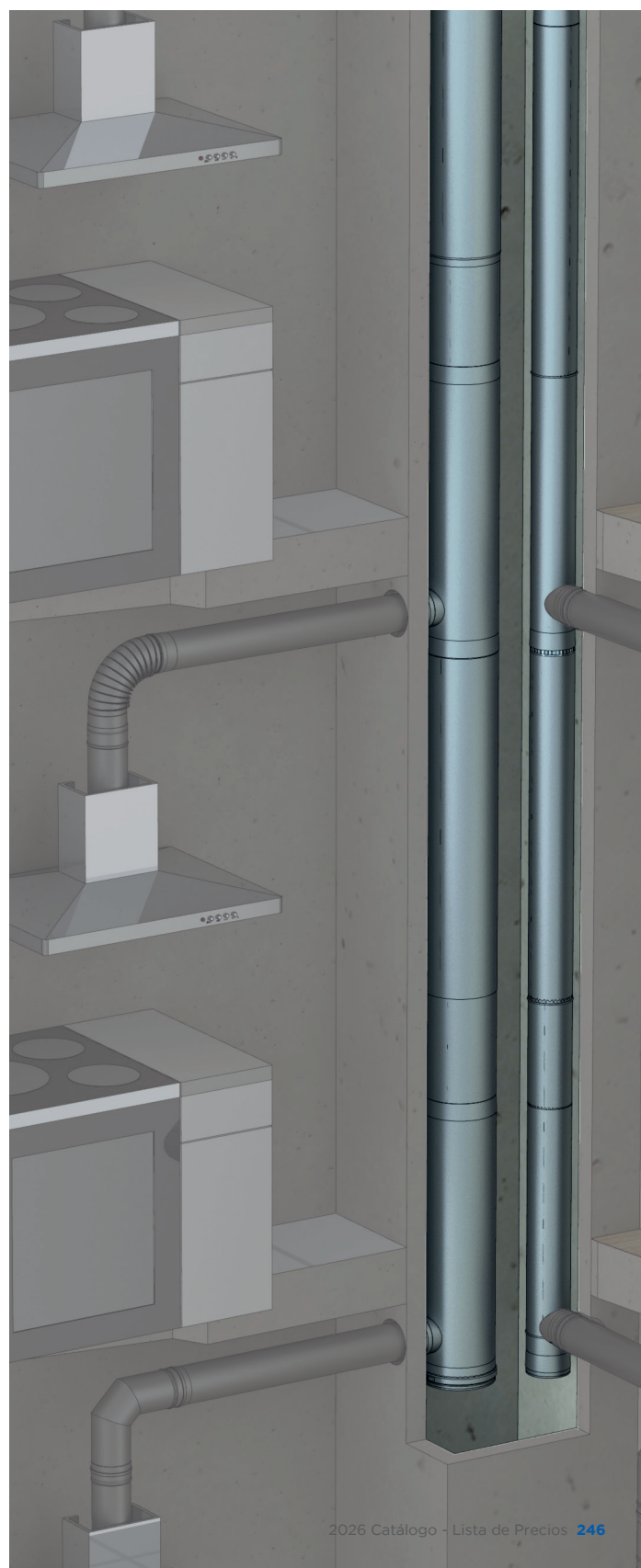

# Ficha Técnica

## SVC3 Canalizado

**ekko**air  
by jeremias

Conducto modular colectivo liso y con soldadura láser por extracción de campanas de cocina doméstica de simple pared.



2000 Pa

Ø DISPONIBLES (mm)	Ø 130 a Ø600
MATERIAL	Acero galvanizado / zincado (según diámetros)

### ESPESORES (mm)

0,5 - 0,6 (según diámetro)

### SISTEMA DE UNIÓN

Unión cónica hembra-macho sin **abrazadera de unión**

### CERTIFICADO

Clase de estanqueidad D según UNE.EN.12237



### APLICACIONES

Extracción de campanas domésticas.



### CARACTERÍSTICAS

Cumple con todos los requisitos indicados en el CTE. Garantía de **estanqueidad clase D según norma UNE-EN 12237** (conexión cónica metal-metal) **sin necesidad de junta** ni abrazadera de unión. **Soldadura TIG/LASER** en continuo en todas las piezas.

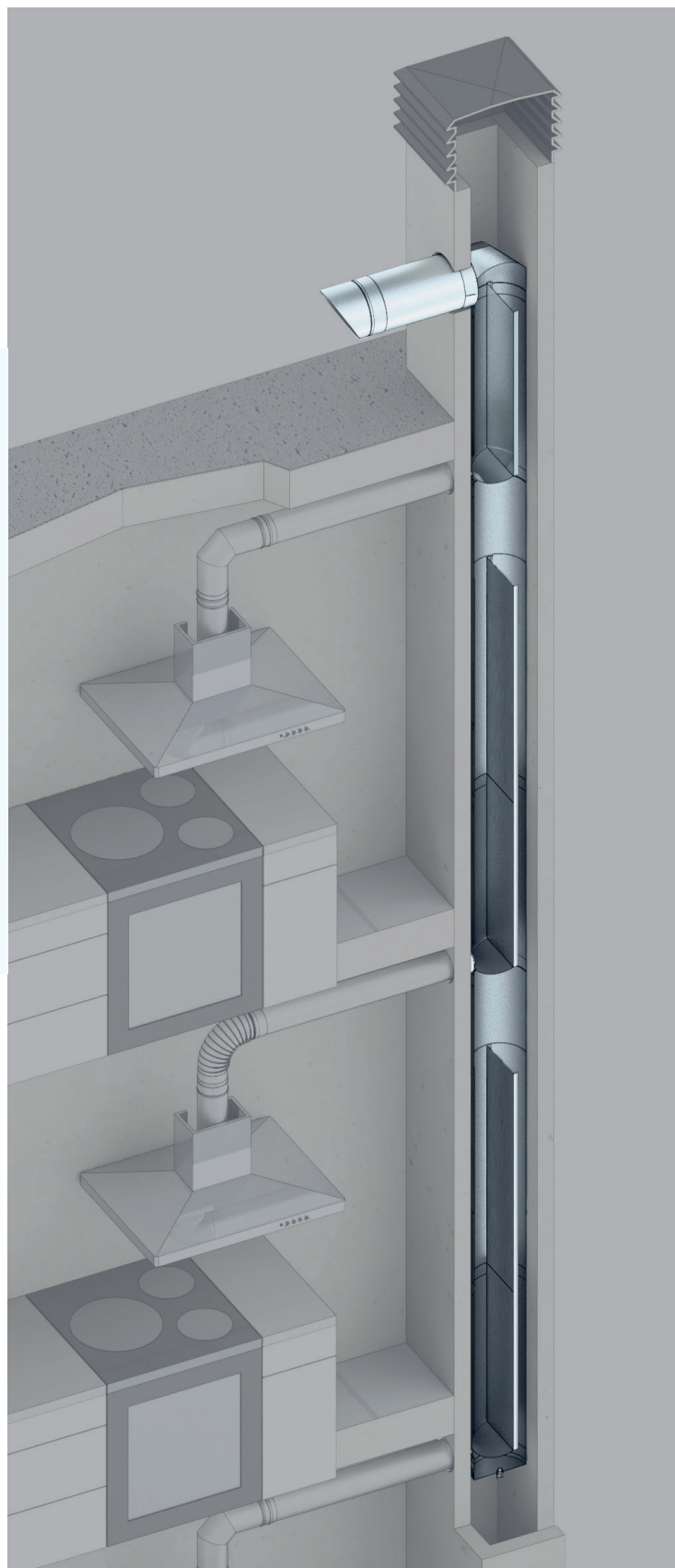

# Ficha Técnica

## SVC4

**ekkoair**  
by jeremias

Conducto modular colectivo liso de acero inoxidable simple pared, para la ventilación de viviendas.



Ø DISPONIBLES (mm)    Ø 130 a Ø600

MATERIAL                    Acero inoxidable AISI 304

### ACABADO EXTERIOR

BA (Brillo)

### ESPEORES (mm)

0,4 - 0,6 (según diámetro)

### SISTEMA DE UNIÓN

Unión cónica hembra-macho con **abrazadera de unión**

### CERTIFICADO

Clase de estanqueidad D según UNE.EN.12237

### APLICACIONES

Ventilación mecánica controlada de viviendas.



### CARACTERÍSTICAS

Cumple con todos los requisitos indicados en el CTE.

Garantía de **estanqueidad clase D según norma UNE-EN 12237 (conexión cónica metal-metal) sin necesidad de junta.**

**Soldadura TIG/LASER** en continuo en todas las piezas

Instalación con **tres piezas por planta** (Te + Módulo recto + Regulable).

Necesidad de abrazadera de unión **NO INCLUIDA** para una correcta conexión entre piezas.



# Ficha Técnica

## SVC4 Canalizado

**ekoair**  
by jeremias

Conducto modular colectivo canalizado de acero inoxidable simple pared, para la extracción de campanas de cocina domésticas.



Ø DISPONIBLES (mm)    Ø 130 a Ø600

MATERIAL                    Acero inoxidable AISI 304

### ACABADO EXTERIOR

BA (Brillo)

### ESPEORES (mm)

0,4 - 0,6 (según diámetro)

### SISTEMA DE UNIÓN

Unión cónica hembra-macho con **abrazadera de unión**

### CERTIFICADO

Clase de estanqueidad D según UNE.EN.12237



### APLICACIONES

Extracción de campanas domésticas



### CARACTERÍSTICAS

Cumple con todos los requisitos indicados en el CTE.

Garantía de **estanqueidad clase D según norma UNE-EN 12237 (conexión cónica metal-metal) sin necesidad de junta.**

**Soldadura TIG/LASER** en continuo en todas las piezas

Instalación con **tres piezas por planta** (Te + Módulo recto + Regulable).

Necesidad de abrazadera de unión **NO INCLUIDA** para una correcta conexión entre piezas.

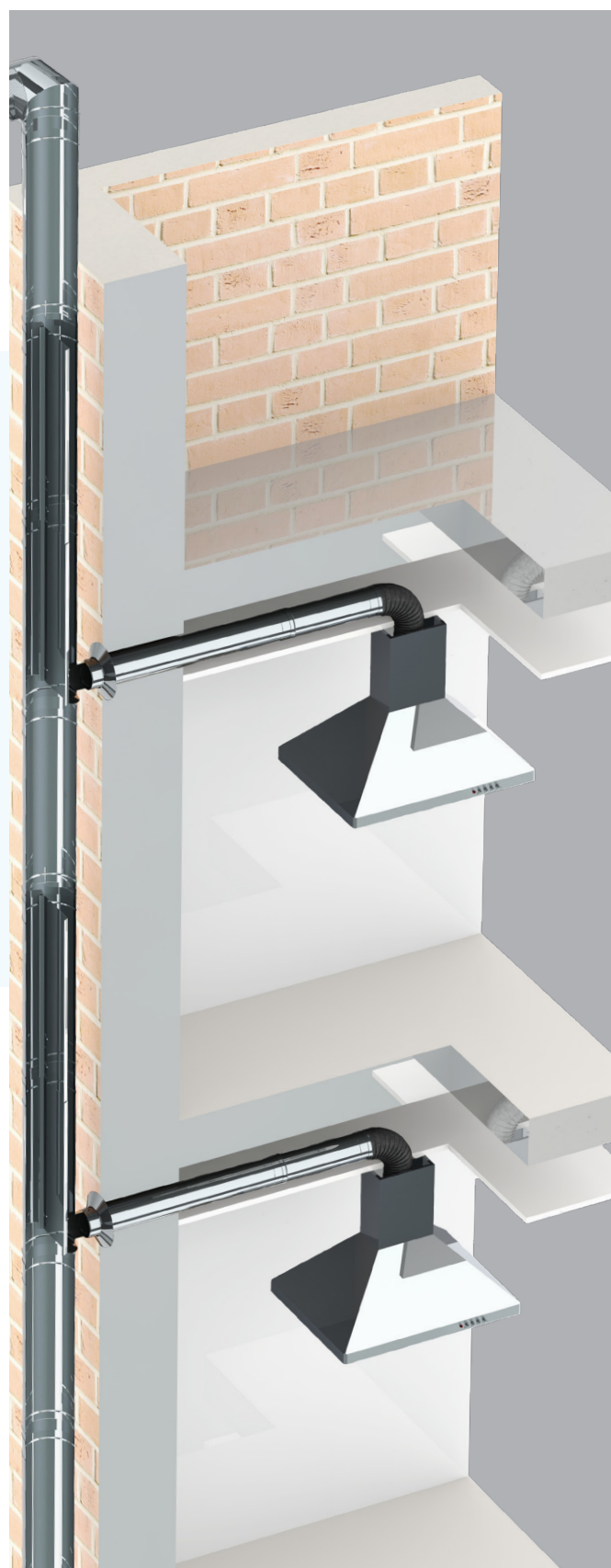

## CONDUCTO SVC-H



Módulo recto 1000mm



Módulo recto 500mm



Módulo recto 500 mm  
deslizante



Codo 45°



Codo 90°

Ø80	684-SVCH130080	13.79€	Ø80	684-SVCH140080	10.34€	Ø130	684-SVCH2790130	12.73€	Ø80	684-SVCH180080	19.91€	Ø80	684-SVCH600080	20.91€
Ø100	684-SVCH130100	14.85€	Ø100	684-SVCH140100	11.14€	Ø150	684-SVCH2790150	14.33€	Ø100	684-SVCH180100	22.08€	Ø100	684-SVCH600100	23.36€
Ø110	684-SVCH130110	15.91€	Ø110	684-SVCH140110	11.94€				Ø110	684-SVCH180110	22.36€	Ø110	684-SVCH600110	23.75€
Ø130	684-SVCH130130	16.97€	Ø130	684-SVCH140130	12.73€				Ø130	684-SVCH180130	23.69€	Ø130	684-SVCH600130	25.36€
Ø150	684-SVCH130150	19.1€	Ø150	684-SVCH140150	14.33€				Ø150	684-SVCH180150	27.58€	Ø150	684-SVCH600150	28.64€
Ø180	684-SVCH130180	22.34€	Ø180	684-SVCH140180	16.76€				Ø180	684-SVCH180180	32.27€	Ø180	684-SVCH600180	33.52€
Ø200	684-SVCH130200	27.19€	Ø200	684-SVCH140200	20.39€				Ø200	684-SVCH180200	39.27€	Ø200	684-SVCH600200	40.78€



Manguito hembra-hembra



Junta tórica para SVC-H



Abrazadera isofónica M-8



Te 90°



Adaptador de máquina a  
SVC-H hembra

Ø80	684-SVCH6130080	7.18€	Ø80	684-SVCHJT0080	0.78€	Ø80	665-ZUWA1063DB0080	4.92€	Ø80	684-SVCH3170080	24.52€	Ø150	684-SVCH39901600150	32.9€
Ø100	684-SVCH6130100	7.67€	Ø100	684-SVCHJT0100	0.78€	Ø100	665-ZUWA1063DB0100	5.46€	Ø100	684-SVCH3170100	26.54€	Ø180	684-SVCH39901600180	34.11€
Ø110	684-SVCH6130110	7.94€	Ø110	684-SVCHJT0110	0.78€	Ø110	665-ZUWA1063DB0110	5.46€	Ø110	684-SVCH3170110	27.25€	Ø200	684-SVCH39901800200	42.76€
Ø130	684-SVCH6130130	8.47€	Ø130	684-SVCHJT0130	1.01€	Ø130	665-ZUWA1063DB0130	6.56€	Ø130	684-SVCH3170130	29.15€			
Ø150	684-SVCH6130150	8.97€	Ø150	684-SVCHJT0150	1.01€	Ø150	665-ZUWA1063DB0150	6.56€	Ø150	684-SVCH3170150	36.54€			
Ø180	684-SVCH6130180	10.5€	Ø180	684-SVCHJT0180	1.01€	Ø180	665-ZUWA1063DB0180	11.38€	Ø180	684-SVCH3170180	42.76€			
Ø200	684-SVCH6130200	12.77€	Ø200	684-SVCHJT0200	1.37€	Ø200	665-ZUWA1063DB0200	14.65€	Ø200	684-SVCH3170200	53€			

## REDUCCIONES

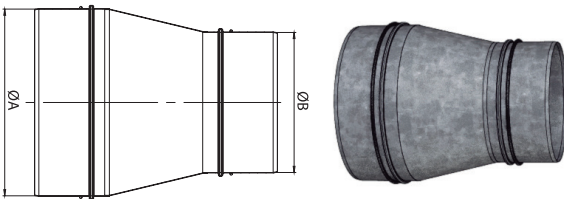

CÓDIGO	Ø A	Ø B	€
684-SVCHRMM01000080	Ø100	Ø80	23.81€
684-SVCHRMM01100080	Ø110	Ø80	24.33€
684-SVCHRMM01300080	Ø130	Ø80	25.73€
684-SVCHRMM01500080	Ø150	Ø80	26.85€
684-SVCHRMM01800080	Ø180	Ø80	26.85€
684-SVCHRMM02000080	Ø200	Ø80	32.67€
684-SVCHRMM01100100	Ø110	Ø100	24.17€
684-SVCHRMM01300100	Ø130	Ø100	25.41€
684-SVCHRMM01500100	Ø150	Ø100	27.3€
684-SVCHRMM01800100	Ø180	Ø100	27.3€

684-SVCHRMM02000100	Ø200	Ø100	33.22€
684-SVCHRMM01300110	Ø130	Ø110	25.32€
684-SVCHRMM01500110	Ø150	Ø110	28.04€
684-SVCHRMM01800110	Ø180	Ø110	28.04€
684-SVCHRMM02000110	Ø200	Ø110	34.11€
684-SVCHRMM01500130	Ø150	Ø130	28.88€
684-SVCHRMM01800130	Ø180	Ø130	28.88€
684-SVCHRMM02000130	Ø200	Ø130	35.14€
684-SVCHRMM01800150	Ø180	Ø150	33.79€
684-SVCHRMM02000150	Ø200	Ø150	41.12€
684-SVCHRMM02000180	Ø200	Ø180	42.76€

# CONDUCTO SVC-D



Módulo recto 1000mm



Módulo recto 500mm



Módulo regulable 1340-2440



Codo 45°



Te conexión Ø80/125

Ø80	681-SVCD130080	71€	Ø80	681-SVCD140080	56€	Ø80	681-SVCD44020080	130€	Ø80	681-SVCD180080	108€	Ø80	681-SVCD43970080	112€
Ø100	681-SVCD130100	78€	Ø100	681-SVCD140100	60€	Ø100	681-SVCD44020100	145€	Ø100	681-SVCD180100	108€	Ø100	681-SVCD43970100	118€
Ø110	681-SVCD130110	85€	Ø110	681-SVCD140110	65€	Ø110	681-SVCD44020110	164€	Ø110	681-SVCD180110	123€	Ø110	681-SVCD43970110	128€
Ø130	681-SVCD130130	93€	Ø130	681-SVCD140130	67€	Ø130	681-SVCD44020130	178€	Ø130	681-SVCD180130	133€	Ø130	681-SVCD43970130	134€
Ø150	681-SVCD130150	101€	Ø150	681-SVCD140150	76€	Ø150	681-SVCD44020150	201€	Ø150	681-SVCD180150	155€	Ø150	681-SVCD43970150	143€
Ø180	681-SVCD130180	116€	Ø180	681-SVCD140180	84€	Ø180	681-SVCD44020180	238€	Ø180	681-SVCD180180	179€	Ø180	681-SVCD43970180	161€
Ø200	681-SVCD130200	129€	Ø200	681-SVCD140200	93€	Ø200	681-SVCD44020200	255€	Ø200	681-SVCD180200	193€	Ø200	681-SVCD43970200	172€
Ø250	681-SVCD130250	155€	Ø250	681-SVCD140250	108€	Ø250	681-SVCD44020250	318€	Ø250	681-SVCD180250	198€	Ø250	681-SVCD43970250	198€
Ø300	681-SVCD130300	166€	Ø300	681-SVCD140300	114€	Ø300	681-SVCD44020300	323€	Ø300	681-SVCD180300	209€	Ø300	681-SVCD43970300	211€
Ø350	681-SVCD130350	177€	Ø350	681-SVCD140350	121€	Ø350	681-SVCD44020350	353€	Ø350	681-SVCD180350	227€	Ø350	v 681-SVCD43970350	222€



Te conexión Ø100/150



Te conexión Ø110/180



Te conexión Ø130/200



Te doble conexión Ø80/125 a 180°



Te doble conexión Ø80/125 a 90°

Ø80	-	-	Ø80	-	-	Ø80	-	-	Ø80	-	-	Ø80	-	-
Ø100	681-SVCD43980100	119€	Ø100	-	-	Ø100	-	-	Ø100	-	-	Ø100	-	-
Ø110	681-SVCD43980110	130€	Ø110	681-SVCD43990110	135€	Ø110	-	-	Ø110	681-SVCD4397D0110	129€	Ø110	-	-
Ø130	681-SVCD43980130	135€	Ø130	681-SVCD43990130	142€	Ø130	681-SVCD44000130	139€	Ø130	681-SVCD4397D0130	135€	Ø130	681-SVCD4397E0130	135€
Ø150	681-SVCD43980150	144€	Ø150	681-SVCD43990150	151€	Ø150	681-SVCD44000150	147€	Ø150	681-SVCD4397D0150	144€	Ø150	681-SVCD4397E0150	144€
Ø180	681-SVCD43980180	163€	Ø180	681-SVCD43990180	168€	Ø180	681-SVCD44000180	166€	Ø180	681-SVCD4397D0180	163€	Ø180	681-SVCD4397E0180	163€
Ø200	681-SVCD43980200	175€	Ø200	681-SVCD43990200	179€	Ø200	681-SVCD44000200	178€	Ø200	681-SVCD4397D0200	173€	Ø200	681-SVCD4397E0200	173€
Ø250	681-SVCD43980250	200€	Ø250	681-SVCD43990250	206€	Ø250	681-SVCD44000250	204€	Ø250	681-SVCD4397D0250	199€	Ø250	681-SVCD4397E0250	199€
Ø300	681-SVCD43980300	212€	Ø300	681-SVCD43990300	217€	Ø300	681-SVCD44000300	215€	Ø300	681-SVCD4397D0300	212€	Ø300	681-SVCD4397E0300	212€
Ø350	681-SVCD43980350	224€	Ø350	681-SVCD43990350	232€	Ø350	681-SVCD44000350	228€	Ø350	681-SVCD4397D0350	225€	Ø350	681-SVCD4397E0350	225€



Te doble conexión Ø100/150 a 180°



Te doble conexión Ø100/150 a 90°



Te doble conexión Ø110/180 a 180°



Te doble conexión Ø110/180 a 90°



Te doble conexión Ø130/200 a 180°

Ø80	-	-	Ø80	-	-	Ø80	-	-	Ø80	-	-	Ø80	-	-
Ø100	-	-	Ø100	-	-	Ø100	-	-	Ø100	-	-	Ø100	-	-
Ø110	-	-	Ø110	-	-	Ø110	-	-	Ø110	-	-	Ø110	-	-
Ø130	681-SVCD4398D0130	139€	Ø110	-	-	Ø110	-	-	Ø110	-	-	Ø110	-	-
Ø150	681-SVCD4398D0150	147€	Ø150	681-SVCD4398E0150	147€	Ø150	681-SVCD4399D0150	155€	Ø110	-	-	Ø110	-	-
Ø180	681-SVCD4398D0180	166€	Ø180	681-SVCD4398E0180	166€	Ø180	681-SVCD4399D0180	172€	Ø180	681-SVCD4399E0180	172€	Ø180	681-SVCD4400D0180	175€
Ø200	681-SVCD4398D0200	178€	Ø200	681-SVCD4398E0200	178€	Ø200	681-SVCD4399D0200	183€	Ø200	681-SVCD4399E0200	183€	Ø200	681-SVCD4400D0200	184€
Ø250	681-SVCD4398D0250	204€	Ø250	681-SVCD4398E0250	204€	Ø250	681-SVCD4399D0250	209€	Ø250	681-SVCD4399E0250	209€	Ø250	681-SVCD4400D0250	211€
Ø300	681-SVCD4398D0300	215€	Ø300	681-SVCD4398E0300	215€	Ø300	681-SVCD4399D0300	221€	Ø300	681-SVCD4399E0300	221€	Ø300	681-SVCD4400D0300	224€
Ø350	681-SVCD4398D0350	232€	Ø350	681-SVCD4398E0350	232€	Ø350	681-SVCD4399D0350	237€	Ø350	681-SVCD4399E0350	237€	Ø350	681-SVCD4400D0350	239€



Te doble conexión  
Ø130/200 a 90°



Te doble conexión Ø100  
simple a 180°



Te doble conexión Ø100  
simple a 90°



Te doble conexión Ø110  
simple a 180°



Te doble conexión Ø110  
simple a 90°

Ø180	681-SVCD4400E0180	175€	Ø80	-	-	Ø80	-	-	Ø80	-	-	Ø80	-	-
Ø200	681-SVCD4400E0200	184€	Ø100	-	-	Ø100	-	-	Ø100	-	-	Ø100	-	-
Ø250	681-SVCD4400E0250	211€	Ø110	-	-	Ø110	-	-	Ø110	-	-	Ø110	-	-
Ø300	681-SVCD4400E0300	224€	Ø130	681-SVCD4398SD0130	121€	Ø130	681-SVCD4398SE0130	121€	Ø130	681-SVCD4399SD0130	125€	Ø130	681-SVCD4399SE0130	125€
Ø350	681-SVCD4400E0350	239€	Ø150	681-SVCD4398SD0150	132€	Ø150	681-SVCD4398SE0150	132€	Ø150	681-SVCD4399SD0150	134€	Ø150	681-SVCD4399SE0150	134€
			Ø180	681-SVCD4398SD0180	147€	Ø180	681-SVCD4398SE0180	147€	Ø180	681-SVCD4399SD0180	151€	Ø180	681-SVCD4399SE0180	151€
			Ø200	681-SVCD4398SD0200	161€	Ø200	681-SVCD4398SE0200	161€	Ø200	681-SVCD4399SD0200	163€	Ø200	681-SVCD4399SE0200	163€
			Ø250	681-SVCD4398SD0250	185€	Ø250	681-SVCD4398SE0250	185€	Ø250	681-SVCD4399SD0250	187€	Ø250	681-SVCD4399SE0250	187€
			Ø300	681-SVCD4398SD0300	199€	Ø300	681-SVCD4398SE0300	199€	Ø300	681-SVCD4399SD0300	201€	Ø300	681-SVCD4399SE0300	201€
			Ø350	681-SVCD4398SD0350	211€	Ø350	681-SVCD4398SE0350	211€	Ø350	681-SVCD4399SD0350	213€	Ø350	681-SVCD4399SE0350	213€



Te doble conexión Ø130  
simple a 180°



Te doble conexión Ø130  
simple a 90°



Te doble conexión Ø80  
simple a 180°



Te doble conexión Ø80  
simple a 90°



Derivación concéntrica  
cortable

Ø150	681-SVCD4400SD0150	135€	Ø80	-	-	Ø100	681-SVCD4397SD0100	106€	Ø100	681-SVCD4397SE0100	106€	Ø80	AXI-SVCD44050080	106€
Ø180	681-SVCD4400SD0180	152€	Ø100	-	-	Ø110	681-SVCD4397SD0110	114€	Ø110	681-SVCD4397SE0110	114€	Ø100	AXI-SVCD44050100	114€
Ø200	681-SVCD4400SD0200	165€	Ø110	-	-	Ø130	681-SVCD4397SD0130	119€	Ø130	681-SVCD4397SE0130	119€	Ø110	AXI-SVCD44050110	125€
Ø250	681-SVCD4400SD0250	190€	Ø110	-	-	Ø150	681-SVCD4397SD0150	130€	Ø150	681-SVCD4397SE0150	130€	Ø130	AXI-SVCD44050130	134€
Ø300	681-SVCD4400SD0300	202€	Ø150	681-SVCD4400SE0150	135€	Ø180	681-SVCD4397SD0180	146€	Ø180	681-SVCD4397SE0180	146€			
Ø350	681-SVCD4400SD0350	214€	Ø180	681-SVCD4400SE0180	152€	Ø200	681-SVCD4397SD0200	160€	Ø200	681-SVCD4397SE0200	160€			
			Ø200	681-SVCD4400SE0200	165€	Ø250	681-SVCD4397SD0250	184€	Ø250	681-SVCD4397SE0250	184€			
			Ø250	681-SVCD4400SE0250	190€	Ø300	681-SVCD4397SD0300	198€	Ø300	681-SVCD4397SE0300	198€			
			Ø300	681-SVCD4400SE0300	202€	Ø350	681-SVCD4397SD0350	209€	Ø350	681-SVCD4397SE0350	209€			
			Ø350	681-SVCD4400SE0350	214€									



Abrazadera forjado  
isofónica galvanizada



Abrazadera isofónica M-8



Collarín antitormenta



Suplemento derivación

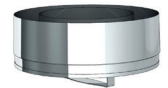

Colector de hollín  
concéntrico

Ø80	665-ZUWA62DB0125	21.25€	Ø80	665-ZUWA1063DB0125	6.56€	Ø80	665-ZUWA3070125	29.27€	Ø80	681-SVCD44070080	46.83€	Ø80	AXI-SVCD21210080	45.31€
Ø100	665-ZUWA62DB0150	22.2€	Ø100	665-ZUWA1063DB0150	6.56€	Ø100	665-ZUWA3070150	34.15€	Ø100	681-SVCD44070100	50€	Ø100	AXI-SVCD21210100	47.48€
Ø110	665-ZUWA62DB0180	23.68€	Ø110	665-ZUWA1063DB0180	11.38€	Ø110	665-ZUWA3070180	40.87€	Ø110	681-SVCD44070110	56€	Ø110	AXI-SVCD21210110	49.92€
Ø130	665-ZUWA62DB0200	24.7€	Ø130	665-ZUWA1063DB0200	14.65€	Ø130	665-ZUWA3070200	47.13€	Ø130	681-SVCD44070130	59€	Ø130	AXI-SVCD21210130	58€
Ø150	665-ZUWA62DB0230	26.15€	Ø150	665-ZUWA1063DB0230	17.9€	Ø150	665-ZUWA3070230	52€				Ø150	AXI-SVCD21210150	62€
Ø180	665-ZUWA62DB0280	28.63€	Ø180	665-ZUWA1063DB0280	19.51€	Ø180	665-ZUWA3070280	71€				Ø180	AXI-SVCD21210180	68€
Ø200	665-ZUWA62DB0300	32.87€	Ø200	665-ZUWA1063DB0300	19.51€	Ø200	665-ZUWA3070300	71€				Ø200	AXI-SVCD21210200	78€
Ø250	665-ZUWA62DB0400	38.4€	Ø250	665-ZUWA1063DB0400	39.04€	Ø250	665-ZUWA3070400	83€				Ø250	AXI-SVCD21210250	93€
Ø300	665-ZUWA62DB0450	46.47€	Ø300	665-ZUWA1063DB0450	44€	Ø300	665-ZUWA3070450	114€				Ø300	AXI-SVCD21210300	106€
Ø350	665-ZUWA62DB0500	57€	Ø350	665-ZUWA1063DB0500	47.13€	Ø350	665-ZUWA3070500	151€				Ø350	AXI-SVCD21210350	119€

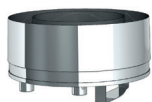

Colector de hollín con doble desagüe

### KIT REMATE INDIVIDUAL

Ø80	AXI-SVCD20500080	68€
Ø100	AXI-SVCD20500100	71€
Ø110	AXI-SVCD20500110	74€
Ø130	AXI-SVCD20500130	81€
Ø150	AXI-SVCD20500150	84€
Ø180	AXI-SVCD20500180	93€
Ø200	AXI-SVCD20500200	101€
Ø250	AXI-SVCD20500250	114€
Ø300	AXI-SVCD20500300	128€
Ø350	AXI-SVCD20500350	142€

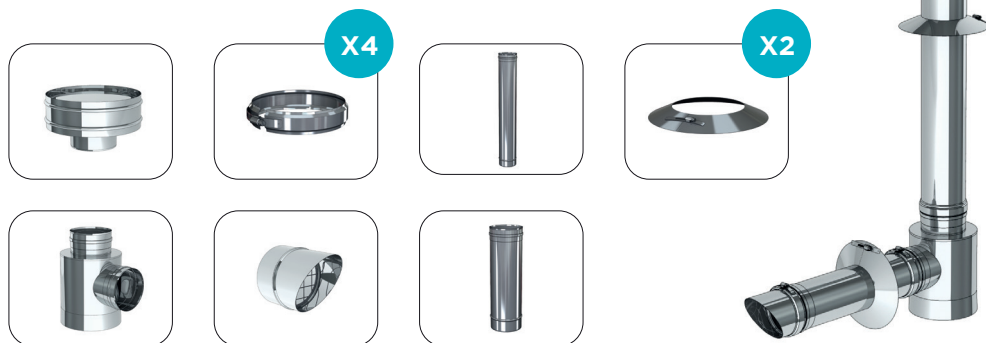

### KIT REMATE COLECTIVO

Ø	CÓDIGO	KIT	€
Ø100	AXI-SVCDKRC0100	Kit remate colectivo	216€
Ø110	AXI-SVCDKRC0110	Kit remate colectivo	234€
Ø130	AXI-SVCDKRC0130	Kit remate colectivo	254€
Ø150	AXI-SVCDKRC0150	Kit remate colectivo	278€
Ø180	AXI-SVCDKRC0180	Kit remate colectivo	333€
Ø200	AXI-SVCDKRC0200	Kit remate colectivo	422€
Ø250	AXI-SVCDKRC0250	Kit remate colectivo	524€
Ø300	AXI-SVCDKRC0300	Kit remate colectivo	606€
Ø350	AXI-SVCDKRC0350	Kit remate colectivo	665€



### KIT SALIDA VERTICAL

Ø	CÓDIGO	KIT	€
Ø100	AXI-SVCDKSV0100	Kit salida vertical	233€
Ø110	AXI-SVCDKSV0110	Kit salida vertical	255€
Ø130	AXI-SVCDKSV0130	Kit salida vertical	274€

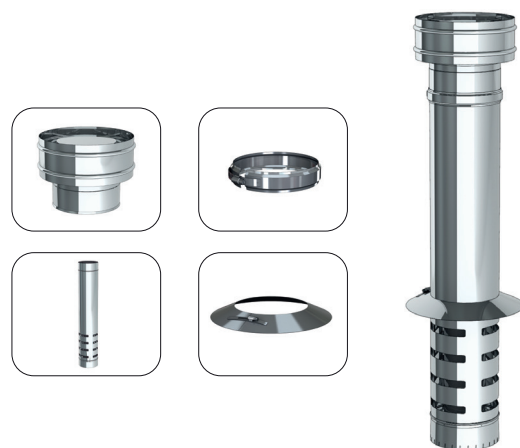

## CONDUCTO SVC-T TRIPLE PARED



Módulo recto 1000mm



Módulo recto 500mm



Módulo recto 250mm



Módulo recto regulable  
580-960mm



Codo 45°

Ø110	686-SVCT130110	216€	Ø110	686-SVCT140110	144€	Ø110	686-SVCT150110	114€	Ø110	686-SVCT5450110	253€	Ø110	686-SVCT180110	136€
Ø130	686-SVCT130130	239€	Ø130	686-SVCT140130	160€	Ø130	686-SVCT150130	123€	Ø150	686-SVCT5450150	305€	Ø130	686-SVCT180130	145€
Ø150	686-SVCT130150	266€	Ø150	686-SVCT140150	176€	Ø150	686-SVCT150150	136€	Ø180	686-SVCT5450180	359€	Ø150	686-SVCT180150	162€
Ø180	686-SVCT130180	319€	Ø180	686-SVCT140180	205€	Ø180	686-SVCT150180	160€	Ø200	686-SVCT5450200	385€	Ø180	686-SVCT180180	208€
Ø200	686-SVCT130200	346€	Ø200	686-SVCT140200	217€	Ø200	686-SVCT150200	169€	Ø250	686-SVCT5450250	449€	Ø200	686-SVCT180200	225€
Ø250	686-SVCT130250	400€	Ø250	686-SVCT140250	245€	Ø250	686-SVCT150250	183€	Ø300	686-SVCT5450300	506€	Ø250	686-SVCT180250	258€
Ø300	686-SVCT130300	449€	Ø300	686-SVCT140300	280€	Ø300	686-SVCT150300	216€	Ø350	686-SVCT5450350	547€	Ø300	686-SVCT180300	293€
Ø350	686-SVCT130350	483€	Ø350	686-SVCT140350	298€	Ø350	686-SVCT150350	232€	Ø400	686-SVCT5450400	645€	Ø350	686-SVCT180350	320€
Ø400	686-SVCT130400	575€	Ø400	686-SVCT140400	353€	Ø400	686-SVCT150400	274€				Ø400	686-SVCT180400	368€



Te 90°



Manguito macho-macho



Derivación a recuperador



Collarín antitormenta



Abrazadera isofónica M-8

Ø110	AZI-SVCT3170110	270€	Ø110	686-SVCT9720110	100€	Ø110	AZI-SVCT44080110	354€	Ø110	665-ZUWA3070230	52€	Ø110	665-ZUWA1063DB0230	17.9€
Ø130	AZI-SVCT3170130	321€	Ø130	686-SVCT9720130	109€	Ø150	AZI-SVCT44080150	424€	Ø130	665-ZUWA3070250	59€	Ø130	665-ZUWA1063DB0250	17.9€
Ø150	AZI-SVCT3170150	356€	Ø150	686-SVCT9720150	119€	Ø180	AZI-SVCT44080180	493€	Ø150	665-ZUWA3070280	71€	Ø150	665-ZUWA1063DB0280	19.51€
Ø180	AZI-SVCT3170180	408€	Ø180	686-SVCT9720180	135€	Ø200	AZI-SVCT44080200	538€	Ø180	665-ZUWA3070330	77€	Ø180	665-ZUWA1063DB0330	32.52€
Ø200	AZI-SVCT3170200	469€	Ø200	686-SVCT9720200	145€	Ø250	AZI-SVCT44080250	850€	Ø200	665-ZUWA3070350	77€	Ø200	665-ZUWA1063DB0350	32.52€
Ø250	AZI-SVCT3170250	711€	Ø250	686-SVCT9720250	151€	Ø300	AZI-SVCT44080300	991€	Ø250	665-ZUWA3070450	114€	Ø250	665-ZUWA1063DB0450	44€
Ø300	AZI-SVCT3170300	952€	Ø300	686-SVCT9720300	185€	Ø350	AZI-SVCT44080350	1109€	Ø300	665-ZUWA3070500	151€	Ø300	665-ZUWA1063DB0500	47.13€
Ø350	AZI-SVCT3170350	891€	Ø350	686-SVCT9720350	200€	Ø400	AZI-SVCT44080400	1254€	Ø350	665-ZUWA3070550	199€	Ø350	665-ZUWA1063DB0550	116€
Ø400	AZI-SVCT3170400	999€	Ø400	686-SVCT9720400	227€				Ø400	665-ZUWA3070615	233€	Ø400	665-ZUWA1063DB0615	147€

## DOBLE PARED



Abrazadera de unión 2.0



Módulo recto 1000mm



Módulo recto 500mm



Módulo recto 250mm

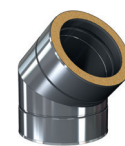

Codo 45°

Ø110	665-ZUWA9890230	19.51€	Ø130	C05-DWECO130130	148€	Ø130	C05-DWECO140130	109€	Ø130	C05-DWECO150130	81€	Ø130	C05-DWECO180130	109€
Ø130	665-ZUWA9890250	26.04€	Ø150	C05-DWECO130150	181€	Ø150	C05-DWECO140150	125€	Ø150	C05-DWECO150150	94€	Ø150	C05-DWECO180150	125€
Ø150	665-ZUWA9890280	29.27€	Ø180	C05-DWECO130180	205€	Ø180	C05-DWECO140180	144€	Ø180	C05-DWECO150180	104€	Ø180	C05-DWECO180180	144€
Ø180	665-ZUWA9890330	34.15€	Ø200	C05-DWECO130200	242€	Ø200	C05-DWECO140200	165€	Ø200	C05-DWECO150200	126€	Ø200	C05-DWECO180200	165€
Ø200	665-ZUWA9890350	34.15€	Ø250	C05-DWECO130250	293€	Ø250	C05-DWECO140250	190€	Ø250	C05-DWECO150250	140€	Ø250	C05-DWECO180250	190€
Ø250	665-ZUWA9890450	48.72€	Ø300	C05-DWECO130300	363€	Ø300	C05-DWECO140300	246€	Ø300	C05-DWECO150300	180€	Ø300	C05-DWECO180300	229€
Ø300	665-ZUWA9890500	54€	Ø350	C05-DWECO130350	454€	Ø350	C05-DWECO140350	308€	Ø350	C05-DWECO150350	240€	Ø350	C05-DWECO180350	312€
Ø350	665-ZUWA9890550	58€	Ø400	C05-DWECO130400	503€	Ø400	C05-DWECO140400	363€	Ø400	C05-DWECO150400	288€	Ø400	C05-DWECO180400	388€
Ø400	665-ZUWA9890615	71€												

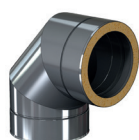

Codo 90°



Junta de silicona  
(T<200°C)

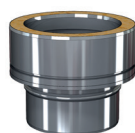

Adaptador simple a doble

Adaptador maquina M-M

Ø130	C05-DWECO600130	152€	Ø130	665-ZUWA260130	4.88€	Ø130	C05-DWECO370130	53€	Ø160	684-SVCH41901600160	14.54€
Ø150	C05-DWECO600150	173€	Ø150	665-ZUWA260150	4.88€	Ø150	C05-DWECO370150	60€	Ø200	684-SVCH41902000200	17.35€
Ø180	C05-DWECO600180	199€	Ø180	665-ZUWA260180	6.52€	Ø180	C05-DWECO370180	72€			
Ø200	C05-DWECO600200	228€	Ø200	665-ZUWA260200	8.15€	Ø200	C05-DWECO370200	84€			
Ø250	C05-DWECO600250	274€	Ø250	665-ZUWA260250	11.38€	Ø250	C05-DWECO370250	102€			
Ø300	C05-DWECO600300	355€	Ø300	665-ZUWA260300	14.65€	Ø300	C05-DWECO370300	132€			
Ø350	C05-DWECO600350	445€	Ø350	665-ZUWA260350	17.9€	Ø350	C05-DWECO370350	163€			
			Ø400	665-ZUWA260400	19.51€	Ø400	C05-DWECO370400	199€			

## AMPLIACIONES

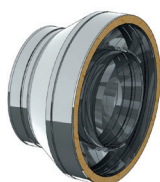

AZI-SVCTA01100130	Ø110	Ø130	229€
AZI-SVCTA01300150	Ø130	Ø150	246€
AZI-SVCTA01250150	Ø125	Ø150	253€
AZI-SVCTA01100150	Ø110	Ø150	254€
AZI-SVCTA01100180	Ø110	Ø180	275€
AZI-SVCTA01300180	Ø130	Ø180	285€
AZI-SVCTA01500180	Ø150	Ø180	293€
AZI-SVCTA01250180	Ø125	Ø180	294€
AZI-SVCTA01100200	Ø110	Ø200	293€
AZI-SVCTA01800200	Ø180	Ø200	295€
AZI-SVCTA01300200	Ø130	Ø200	302€
AZI-SVCTA01500200	Ø150	Ø200	305€
AZI-SVCTA01250200	Ø125	Ø200	311€
AZI-SVCTA01100250	Ø110	Ø250	343€
AZI-SVCTA01300250	Ø130	Ø250	344€
AZI-SVCTA01250250	Ø125	Ø250	354€
AZI-SVCTA01500250	Ø150	Ø250	359€
AZI-SVCTA01800250	Ø180	Ø250	375€
AZI-SVCTA02000250	Ø200	Ø250	385€
AZI-SVCTA01500300	Ø150	Ø300	385€
AZI-SVCTA01800300	Ø180	Ø300	405€
AZI-SVCTA02000300	Ø200	Ø300	419€
AZI-SVCTA02500300	Ø250	Ø300	455€
AZI-SVCTA02000350	Ø200	Ø350	444€
AZI-SVCTA02500350	Ø250	Ø350	490€
AZI-SVCTA03000350	Ø300	Ø350	502€
AZI-SVCTA02500400	Ø250	Ø400	535€
AZI-SVCTA03000400	Ø300	Ø400	569€
AZI-SVCTA03500400	Ø350	Ø400	584€

## REDUCCIONES

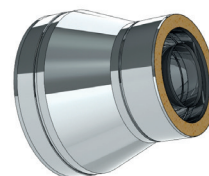

AZI-SVCTR01300110	Ø130	Ø110	229€
AZI-SVCTR01250110	Ø125	Ø110	235€
AZI-SVCTR01500110	Ø150	Ø110	254€
AZI-SVCTR01800110	Ø180	Ø110	275€
AZI-SVCTR02000110	Ø200	Ø110	293€
AZI-SVCTR02500110	Ø250	Ø110	343€
AZI-SVCTR01500130	Ø150	Ø130	246€
AZI-SVCTR01800130	Ø180	Ø130	285€
AZI-SVCTR02000130	Ø200	Ø130	302€
AZI-SVCTR02500130	Ø250	Ø130	344€
AZI-SVCTR01800150	Ø180	Ø150	293€
AZI-SVCTR02000150	Ø200	Ø150	305€
AZI-SVCTR02500150	Ø250	Ø150	359€
AZI-SVCTR03000150	Ø300	Ø150	385€
AZI-SVCTR02000180	Ø200	Ø180	295€
AZI-SVCTR02500180	Ø250	Ø180	375€
AZI-SVCTR03000180	Ø300	Ø180	405€
AZI-SVCTR02500200	Ø250	Ø200	385€
AZI-SVCTR03000200	Ø300	Ø200	419€
AZI-SVCTR03500200	Ø350	Ø200	444€
AZI-SVCTR03000250	Ø300	Ø250	455€
AZI-SVCTR03500250	Ø350	Ø250	490€
AZI-SVCTR04000250	Ø400	Ø250	535€
AZI-SVCTR03500300	Ø350	Ø300	502€
AZI-SVCTR04000300	Ø400	Ø300	569€
AZI-SVCTR04000350	Ø400	Ø350	584€

## CONDUCTO SVC-3



Módulo recto 1250mm



Módulo recto 1000mm



Módulo recto 500mm



Módulo recto 250mm



Módulo recto regulable  
1340-2440mm

Ø130	680-SVC39110130	21.22€	Ø130	680-SVC39090130	16.97€	Ø130	680-SVC39100130	12.73€	Ø130	680-SVC39120130	8.49€	Ø130	680-SVC3540L0130	58€
Ø150	680-SVC39110150	23.88€	Ø150	680-SVC39090150	19.1€	Ø150	680-SVC39100150	14.33€	Ø150	680-SVC39120150	9.55€	Ø150	680-SVC3540L0150	64€
Ø180	680-SVC39110180	34.35€	Ø180	680-SVC39090180	27.82€	Ø180	680-SVC39100180	15.81€	Ø180	680-SVC39120180	9.29€	Ø180	680-SVC3540L0180	73€
Ø200	680-SVC39110200	36.76€	Ø200	680-SVC39090200	30.07€	Ø200	680-SVC39100200	16.91€	Ø200	680-SVC39120200	9.86€	Ø200	680-SVC3540L0200	78€
Ø250	680-SVC39110250	45.84€	Ø250	680-SVC39090250	36.78€	Ø250	680-SVC39100250	20.24€	Ø250	680-SVC39120250	11.53€	Ø250	680-SVC3540L0250	95€
Ø300	680-SVC39110300	58€	Ø300	680-SVC39090300	44.14€	Ø300	680-SVC39100300	27.51€	Ø300	680-SVC39120300	14.24€	Ø300	680-SVC3540L0300	111€
Ø350	680-SVC39110350	63€	Ø350	680-SVC39090350	50€	Ø350	680-SVC39100350	32.02€	Ø350	680-SVC39120350	15.67€	Ø350	680-SVC3540L0350	127€
Ø400	680-SVC39110400	74€	Ø400	680-SVC39090400	59€	Ø400	680-SVC39100400	38.77€	Ø400	680-SVC39120400	17.91€	Ø400	680-SVC3540L0400	145€



Módulo recto 1000mm con  
canalización interior



Módulo recto 1000mm con  
doble canalización int.



Módulo recto reg. 1340-  
2440mm con canaliz. int.



Módulo recto reg. 1340-  
2440mm doble canaliz. int.



Codo 45°

Ø180	680-SVC3130180	43.76€	Ø250	680-SVC39970250	75€	Ø180	680-SVC35420180	104€	Ø250	680-SVC39980250	148€	Ø130	680-SVC3180130	22.96€
Ø200	680-SVC3130200	46.15€	Ø300	680-SVC39970300	85€	Ø200	680-SVC35420200	110€	Ø300	680-SVC39980300	172€	Ø150	680-SVC3180150	25.81€
Ø250	680-SVC3130250	54€	Ø350	680-SVC39970350	95€	Ø250	680-SVC35420250	131€	Ø350	680-SVC39980350	191€	Ø180	680-SVC3180180	27.4€
Ø300	680-SVC3130300	63€	Ø400	680-SVC39970400	107€	Ø300	680-SVC35420300	150€	Ø400	680-SVC39980400	212€	Ø200	680-SVC3180200	28.48€
Ø350	680-SVC3130350	70€				Ø350	680-SVC35420350	168€				Ø250	680-SVC3180250	37.95€
Ø400	680-SVC3130400	79€				Ø400	680-SVC35420400	187€				Ø300	680-SVC3180300	44.71€
												Ø350	680-SVC3180350	52€
												Ø400	680-SVC3180400	56€



Codo 90°



Codo 90° (Hembra EW-  
Eco y Macho SVC3)



Codo 90° (Hembra SVC3 y  
Hembra EW-Eco)

Ø130	680-SVC3600130	35.37€	Ø130	680-SVC360A0130	44.26€	Ø130	680-SVC360B0130	44.26€
Ø150	680-SVC3600150	37.29€	Ø150	680-SVC360A0150	45.29€	Ø150	680-SVC360B0150	45.29€
Ø180	680-SVC3600180	40.55€	Ø180	680-SVC360A0180	51€	Ø180	680-SVC360B0180	51€
Ø200	680-SVC3600200	42.33€	Ø200	680-SVC360A0200	55€	Ø200	680-SVC360B0200	55€
Ø250	680-SVC3600250	47.61€	Ø250	680-SVC360A0250	55€	Ø250	680-SVC360B0250	55€
Ø300	680-SVC3600300	79€	Ø300	680-SVC360A0300	98€	Ø300	680-SVC360B0300	98€
Ø350	680-SVC3600350	93€	Ø350	680-SVC360A0350	108€	Ø350	680-SVC360B0350	108€
Ø400	680-SVC3600400	100€	Ø400	680-SVC360A0400	118€	Ø400	680-SVC360B0400	118€



T90° conex helic.

CÓDIGO	Ø A	Ø B	€
680-SVC314400800130	Ø80	Ø130	43.5€
680-SVC314401000130	Ø100	Ø130	43.5€
680-SVC314401250130	Ø125	Ø130	43.5€
680-SVC314400800150	Ø80	Ø150	46.68€
680-SVC314401000150	Ø100	Ø150	46.68€
680-SVC314401250150	Ø125	Ø150	46.68€
680-SVC314401500150	Ø150	Ø150	46.68€
680-SVC314400800180	Ø80	Ø180	51€
680-SVC314401000180	Ø100	Ø180	51€
680-SVC314401250180	Ø125	Ø180	51€
680-SVC314401500180	Ø150	Ø180	51€
680-SVC314400800200	Ø80	Ø200	55€
680-SVC314401000200	Ø100	Ø200	55€
680-SVC314401250200	Ø125	Ø200	55€
680-SVC314401500200	Ø150	Ø200	55€
680-SVC314400800250	Ø80	Ø250	61€
680-SVC314401000250	Ø100	Ø250	61€
680-SVC314401250250	Ø125	Ø250	61€
680-SVC314401500250	Ø150	Ø250	61€
680-SVC314400800300	Ø80	Ø300	74€
680-SVC314401000300	Ø100	Ø300	74€
680-SVC314401250300	Ø125	Ø300	74€
680-SVC314401500300	Ø150	Ø300	74€
680-SVC314400800350	Ø80	Ø350	79€
680-SVC314401000350	Ø100	Ø350	79€
680-SVC314401250350	Ø125	Ø350	79€
680-SVC314401500350	Ø150	Ø350	79€
680-SVC314400800400	Ø80	Ø400	82€
680-SVC314401000400	Ø100	Ø400	82€
680-SVC314401250400	Ø125	Ø400	82€
680-SVC314401500400	Ø150	Ø400	82€



T90° conex helic. canaliz.

CÓDIGO	Ø A	Ø B	€
680-SVC313201000150	Ø100	Ø150	81€
680-SVC313201000180	Ø100	Ø180	90€
680-SVC313201000200	Ø100	Ø200	95€
680-SVC313201000250	Ø100	Ø250	106€
680-SVC313201000300	Ø100	Ø300	131€
680-SVC313201000350	Ø100	Ø350	138€
680-SVC313201000400	Ø100	Ø400	145€
680-SVC313201250130	Ø125	Ø130	77€
680-SVC313201250150	Ø125	Ø150	81€
680-SVC313201250180	Ø125	Ø180	90€
680-SVC313201250200	Ø125	Ø200	95€
680-SVC313201250250	Ø125	Ø250	106€
680-SVC313201250300	Ø125	Ø300	131€
680-SVC313201250350	Ø125	Ø350	138€
680-SVC313201250400	Ø125	Ø400	145€
680-SVC313201500180	Ø150	Ø180	90€
680-SVC313201500200	Ø150	Ø200	95€
680-SVC313201500250	Ø150	Ø250	106€
680-SVC313201500300	Ø150	Ø300	131€
680-SVC313201500350	Ø150	Ø350	138€
680-SVC313201500400	Ø150	Ø400	145€
680-SVC313200800130	Ø80	Ø130	68€
680-SVC313200800150	Ø80	Ø150	72€
680-SVC313200800180	Ø80	Ø180	90€
680-SVC313200800200	Ø80	Ø200	95€
680-SVC313200800250	Ø80	Ø250	106€
680-SVC313200800300	Ø80	Ø300	131€
680-SVC313200800350	Ø80	Ø350	138€
680-SVC313200800400	Ø80	Ø400	145€



T90° conex PVC

CÓDIGO	Ø A	Ø B	€
680-SVC314701000150	Ø100	Ø150	46.68€
680-SVC314701000180	Ø100	Ø180	51€
680-SVC314701000200	Ø100	Ø200	55€
680-SVC314701000250	Ø100	Ø250	61€
680-SVC314701000300	Ø100	Ø300	74€
680-SVC314701000350	Ø100	Ø350	79€
680-SVC314701000400	Ø100	Ø400	82€
680-SVC314701200130	Ø120	Ø130	43.5€
680-SVC314701200150	Ø120	Ø150	46.68€
680-SVC314701200180	Ø120	Ø180	51€
680-SVC314701200200	Ø120	Ø200	55€
680-SVC314701200250	Ø120	Ø250	61€
680-SVC314701200300	Ø120	Ø300	74€
680-SVC314701200350	Ø120	Ø350	79€
680-SVC314701200400	Ø120	Ø400	82€
680-SVC314701250130	Ø125	Ø130	43.5€
680-SVC314701250150	Ø125	Ø150	46.68€
680-SVC314701250180	Ø125	Ø180	51€
680-SVC314701250200	Ø125	Ø200	55€
680-SVC314701250250	Ø125	Ø250	61€
680-SVC314701250300	Ø125	Ø300	74€
680-SVC314701250350	Ø125	Ø350	79€
680-SVC314701250400	Ø125	Ø400	82€
680-SVC314701500150	Ø150	Ø150	46.68€
680-SVC314701500180	Ø150	Ø180	51€
680-SVC314701500200	Ø150	Ø200	55€
680-SVC314701500250	Ø150	Ø250	61€
680-SVC314701500300	Ø150	Ø300	74€
680-SVC314701500350	Ø150	Ø350	79€
680-SVC314701500400	Ø150	Ø400	82€



T90° conex PVC canaliz.



T90° conex SVC3



T90° conex SVC3 canaliz.

CÓDIGO	Ø A	Ø B	€
680-SVC313501000150	Ø100	Ø150	81€
680-SVC313501000180	Ø100	Ø180	90€
680-SVC313501000200	Ø100	Ø200	95€
680-SVC313501000250	Ø100	Ø250	106€
680-SVC313501000300	Ø100	Ø300	131€
680-SVC313501000350	Ø100	Ø350	138€
680-SVC313501000400	Ø100	Ø400	145€
680-SVC313501200130	Ø120	Ø130	77€
680-SVC313501200150	Ø120	Ø150	81€
680-SVC313501200180	Ø120	Ø180	90€
680-SVC313501200200	Ø120	Ø200	95€
680-SVC313501200250	Ø120	Ø250	106€
680-SVC313501200300	Ø120	Ø300	131€
680-SVC313501200350	Ø120	Ø350	138€
680-SVC313501200400	Ø120	Ø400	145€
680-SVC313501250130	Ø125	Ø130	77€
680-SVC313501250150	Ø125	Ø150	81€
680-SVC313501250180	Ø125	Ø180	90€
680-SVC313501250200	Ø125	Ø200	95€
680-SVC313501250250	Ø125	Ø250	106€
680-SVC313501250300	Ø125	Ø300	131€
680-SVC313501250350	Ø125	Ø350	138€
680-SVC313501250400	Ø125	Ø400	145€
680-SVC313501500180	Ø150	Ø180	90€
680-SVC313501500200	Ø150	Ø200	95€
680-SVC313501500250	Ø150	Ø250	106€
680-SVC313501500300	Ø150	Ø300	131€
680-SVC313501500350	Ø150	Ø350	138€
680-SVC313501500400	Ø150	Ø400	145€

CÓDIGO	Ø A	Ø B	€
680-SVC314501300150	Ø130	Ø150	46.68€
680-SVC314501300180	Ø130	Ø180	51€
680-SVC314501300200	Ø130	Ø200	55€
680-SVC314501300250	Ø130	Ø250	61€
680-SVC314501300300	Ø130	Ø300	74€
680-SVC314501300350	Ø130	Ø350	79€
680-SVC314501300400	Ø130	Ø400	82€
680-SVC314501500150	Ø150	Ø150	46.68€
680-SVC314501500180	Ø150	Ø180	51€
680-SVC314501500200	Ø150	Ø200	55€
680-SVC314501500250	Ø150	Ø250	61€
680-SVC314501500300	Ø150	Ø300	74€
680-SVC314501500350	Ø150	Ø350	79€
680-SVC314501500400	Ø150	Ø400	82€

CÓDIGO	Ø A	Ø B	€
680-SVC313301300180	Ø130	Ø180	90€
680-SVC313301300200	Ø130	Ø200	95€
680-SVC313301300250	Ø130	Ø250	106€
680-SVC313301300300	Ø130	Ø300	131€
680-SVC313301300350	Ø130	Ø350	138€
680-SVC313301300400	Ø130	Ø400	145€
680-SVC313301500180	Ø150	Ø180	90€
680-SVC313301500200	Ø150	Ø200	95€
680-SVC313301500250	Ø150	Ø250	106€
680-SVC313301500300	Ø150	Ø300	131€
680-SVC313301500350	Ø150	Ø350	138€
680-SVC313301500400	Ø150	Ø400	145€



T90° conex SVCH



T90° conex SVCH canaliz.



T90° d. conex. 180° helic.

CÓDIGO	Ø A	Ø B	€
680-SVC314601000150	Ø100	Ø150	46.68€
680-SVC314601000180	Ø100	Ø180	51€
680-SVC314601000200	Ø100	Ø200	55€
680-SVC314601000250	Ø100	Ø250	61€
680-SVC314601000300	Ø100	Ø300	74€
680-SVC314601000350	Ø100	Ø350	79€
680-SVC314601000400	Ø100	Ø400	82€
680-SVC314601100130	Ø110	Ø130	43.5€
680-SVC314601100150	Ø110	Ø150	46.68€
680-SVC314601100180	Ø110	Ø180	51€
680-SVC314601100200	Ø110	Ø200	55€
680-SVC314601100250	Ø110	Ø250	61€
680-SVC314601100300	Ø110	Ø300	74€
680-SVC314601100350	Ø110	Ø350	79€
680-SVC314601100400	Ø110	Ø400	82€
680-SVC314601300130	Ø130	Ø130	43.5€
680-SVC314601300150	Ø130	Ø150	46.68€
680-SVC314601300180	Ø130	Ø180	51€
680-SVC314601300200	Ø130	Ø200	55€
680-SVC314601300250	Ø130	Ø250	61€
680-SVC314601300300	Ø130	Ø300	74€
680-SVC314601300350	Ø130	Ø350	79€
680-SVC314601300400	Ø130	Ø400	82€
680-SVC314601500150	Ø150	Ø150	46.68€
680-SVC314601500180	Ø150	Ø180	51€
680-SVC314601500200	Ø150	Ø200	55€
680-SVC314601500250	Ø150	Ø250	61€
680-SVC314601500300	Ø150	Ø300	74€
680-SVC314601500350	Ø150	Ø350	79€
680-SVC314601500400	Ø150	Ø400	82€
680-SVC314600800130	Ø80	Ø130	43.5€
680-SVC314600800150	Ø80	Ø150	46.68€
680-SVC314600800180	Ø80	Ø180	51€
680-SVC314600800200	Ø80	Ø200	55€
680-SVC314600800250	Ø80	Ø250	61€
680-SVC314600800300	Ø80	Ø300	74€
680-SVC314600800350	Ø80	Ø350	79€
680-SVC314600800400	Ø80	Ø400	82€

CÓDIGO	Ø A	Ø B	€
680-SVC313401000150	Ø100	Ø150	81€
680-SVC313401000180	Ø100	Ø180	90€
680-SVC313401000200	Ø100	Ø200	95€
680-SVC313401000250	Ø100	Ø250	106€
680-SVC313401000300	Ø100	Ø300	131€
680-SVC313401000350	Ø100	Ø350	138€
680-SVC313401000400	Ø100	Ø400	145€
680-SVC313401100130	Ø110	Ø130	77€
680-SVC313401100150	Ø110	Ø150	81€
680-SVC313401100180	Ø110	Ø180	90€
680-SVC313401100200	Ø110	Ø200	95€
680-SVC313401100250	Ø110	Ø250	106€
680-SVC313401100300	Ø110	Ø300	131€
680-SVC313401100350	Ø110	Ø350	138€
680-SVC313401100400	Ø110	Ø400	145€
680-SVC313401300150	Ø130	Ø150	81€
680-SVC313401300180	Ø130	Ø180	90€
680-SVC313401300200	Ø130	Ø200	95€
680-SVC313401300250	Ø130	Ø250	106€
680-SVC313401300300	Ø130	Ø300	131€
680-SVC313401300350	Ø130	Ø350	138€
680-SVC313401300400	Ø130	Ø400	145€
680-SVC313401500180	Ø150	Ø180	90€
680-SVC313401500200	Ø150	Ø200	95€
680-SVC313401500250	Ø150	Ø250	106€
680-SVC313401500300	Ø150	Ø300	131€
680-SVC313401500350	Ø150	Ø350	138€
680-SVC313401500400	Ø150	Ø400	145€
680-SVC313400800130	Ø80	Ø130	78€
680-SVC313400800150	Ø80	Ø150	81€
680-SVC313400800180	Ø80	Ø180	90€
680-SVC313400800200	Ø80	Ø200	95€
680-SVC313400800250	Ø80	Ø250	106€
680-SVC313400800300	Ø80	Ø300	131€
680-SVC313400800350	Ø80	Ø350	138€
680-SVC313400800400	Ø80	Ø400	145€

CÓDIGO	Ø A	Ø B	€
680-SVC314001000150	Ø100	Ø150	55€
680-SVC314001000180	Ø100	Ø180	59€
680-SVC314001000200	Ø100	Ø200	61€
680-SVC314001000250	Ø100	Ø250	71€
680-SVC314001000300	Ø100	Ø300	83€
680-SVC314001000350	Ø100	Ø350	92€
680-SVC314001000400	Ø100	Ø400	95€
680-SVC314001250180	Ø125	Ø180	59€
680-SVC314001250200	Ø125	Ø200	61€
680-SVC314001250250	Ø125	Ø250	71€
680-SVC314001250300	Ø125	Ø300	83€
680-SVC314001250350	Ø125	Ø350	92€
680-SVC314001250400	Ø125	Ø400	95€
680-SVC314001500200	Ø150	Ø200	61€
680-SVC314001500250	Ø150	Ø250	71€
680-SVC314001500300	Ø150	Ø300	83€
680-SVC314001500350	Ø150	Ø350	92€
680-SVC314001500400	Ø150	Ø400	95€
680-SVC314000800130	Ø80	Ø130	52€
680-SVC314000800150	Ø80	Ø150	55€
680-SVC314000800180	Ø80	Ø180	59€
680-SVC314000800200	Ø80	Ø200	61€
680-SVC314000800250	Ø80	Ø250	71€
680-SVC314000800300	Ø80	Ø300	83€
680-SVC314000800350	Ø80	Ø350	92€
680-SVC314000800400	Ø80	Ø400	95€



T90° d. conex. 180° helic. d. canaliz.

CÓDIGO	Ø A	Ø B	€
680-SVC313601000300	Ø100	Ø300	141€
680-SVC313601000350	Ø100	Ø350	158€
680-SVC313601000400	Ø100	Ø400	167€
680-SVC313601250250	Ø125	Ø250	130€
680-SVC313601250300	Ø125	Ø300	141€
680-SVC313601250350	Ø125	Ø350	158€
680-SVC313601250400	Ø125	Ø400	167€
680-SVC313601500250	Ø150	Ø250	130€
680-SVC313601500300	Ø150	Ø300	141€
680-SVC313601500350	Ø150	Ø350	158€
680-SVC313601500400	Ø150	Ø400	167€
680-SVC313600800250	Ø80	Ø250	130€
680-SVC313600800300	Ø80	Ø300	141€
680-SVC313600800350	Ø80	Ø350	158€
680-SVC313600800400	Ø80	Ø400	167€



T90° d. conex. 180° PVC

CÓDIGO	Ø A	Ø B	€
680-SVC314301000150	Ø100	Ø150	55€
680-SVC314301000180	Ø100	Ø180	59€
680-SVC314301000200	Ø100	Ø200	61€
680-SVC314301000250	Ø100	Ø250	71€
680-SVC314301000300	Ø100	Ø300	83€
680-SVC314301000350	Ø100	Ø350	92€
680-SVC314301000400	Ø100	Ø400	95€
680-SVC314301200180	Ø120	Ø180	59€
680-SVC314301200200	Ø120	Ø200	61€
680-SVC314301200250	Ø120	Ø250	71€
680-SVC314301200300	Ø120	Ø300	83€
680-SVC314301200350	Ø120	Ø350	92€
680-SVC314301200400	Ø120	Ø400	95€
680-SVC314301250180	Ø125	Ø180	59€
680-SVC314301250200	Ø125	Ø200	61€
680-SVC314301250250	Ø125	Ø250	71€
680-SVC314301250300	Ø125	Ø300	83€
680-SVC314301250350	Ø125	Ø350	92€
680-SVC314301250400	Ø125	Ø400	95€
680-SVC314301500200	Ø150	Ø200	61€
680-SVC314301500250	Ø150	Ø250	71€
680-SVC314301500300	Ø150	Ø300	83€
680-SVC314301500350	Ø150	Ø350	92€
680-SVC314301500400	Ø150	Ø400	95€



T90° d. conex. 180° PVC d. canaliz.

CÓDIGO	Ø A	Ø B	€
680-SVC313901000300	Ø100	Ø300	141€
680-SVC313901000350	Ø100	Ø350	158€
680-SVC313901000400	Ø100	Ø400	167€
680-SVC313901200250	Ø120	Ø250	130€
680-SVC313901200300	Ø120	Ø300	141€
680-SVC313901200350	Ø120	Ø350	158€
680-SVC313901200400	Ø120	Ø400	167€
680-SVC313901250250	Ø125	Ø250	130€
680-SVC313901250300	Ø125	Ø300	141€
680-SVC313901250350	Ø125	Ø350	158€
680-SVC313901250400	Ø125	Ø400	167€
680-SVC313901500250	Ø150	Ø250	130€
680-SVC313901500300	Ø150	Ø300	141€
680-SVC313901500350	Ø150	Ø350	158€
680-SVC313901500400	Ø150	Ø400	167€



T90° d. conex. 180° SVC3

CÓDIGO	Ø A	Ø B	€
680-SVC314101300200	Ø130	Ø200	61€
680-SVC314101300250	Ø130	Ø250	71€
680-SVC314101300300	Ø130	Ø300	83€
680-SVC314101300350	Ø130	Ø350	92€
680-SVC314101300400	Ø130	Ø400	95€
680-SVC314101500200	Ø150	Ø200	61€
680-SVC314101500250	Ø150	Ø250	71€
680-SVC314101500300	Ø150	Ø300	83€
680-SVC314101500350	Ø150	Ø350	92€
680-SVC314101500400	Ø150	Ø400	95€

T90° d. conex. 180° SVC3  
d. canaliz.

CÓDIGO	Ø A	Ø B	€
680-SVC313701300300	Ø130	Ø300	141€
680-SVC313701300350	Ø130	Ø350	158€
680-SVC313701300400	Ø130	Ø400	167€
680-SVC313701500250	Ø150	Ø250	130€
680-SVC313701500300	Ø150	Ø300	141€
680-SVC313701500350	Ø150	Ø350	158€
680-SVC313701500400	Ø150	Ø400	167€



T90° d. conex. 180° SVCH

CÓDIGO	Ø A	Ø B	€
680-SVC314201000150	Ø100	Ø150	55€
680-SVC314201000180	Ø100	Ø180	59€
680-SVC314201000200	Ø100	Ø200	61€
680-SVC314201000250	Ø100	Ø250	71€
680-SVC314201000300	Ø100	Ø300	83€
680-SVC314201000350	Ø100	Ø350	92€
680-SVC314201000400	Ø100	Ø400	95€
680-SVC314201100150	Ø110	Ø150	55€
680-SVC314201100180	Ø110	Ø180	59€
680-SVC314201100200	Ø110	Ø200	61€
680-SVC314201100250	Ø110	Ø250	71€
680-SVC314201100300	Ø110	Ø300	83€
680-SVC314201100350	Ø110	Ø350	92€
680-SVC314201100400	Ø110	Ø400	95€
680-SVC314201300150	Ø130	Ø150	55€
680-SVC314201300180	Ø130	Ø180	59€
680-SVC314201300200	Ø130	Ø200	61€
680-SVC314201300250	Ø130	Ø250	71€
680-SVC314201300300	Ø130	Ø300	83€
680-SVC314201300350	Ø130	Ø350	92€
680-SVC314201300400	Ø130	Ø400	95€
680-SVC314201500200	Ø150	Ø200	61€
680-SVC314201500250	Ø150	Ø250	71€
680-SVC314201500300	Ø150	Ø300	83€
680-SVC314201500350	Ø150	Ø350	92€
680-SVC314201500400	Ø150	Ø400	95€
680-SVC314200800130	Ø80	Ø130	52€
680-SVC314200800150	Ø80	Ø150	55€
680-SVC314200800180	Ø80	Ø180	59€
680-SVC314200800200	Ø80	Ø200	61€
680-SVC314200800250	Ø80	Ø250	71€
680-SVC314200800300	Ø80	Ø300	83€
680-SVC314200800350	Ø80	Ø350	92€
680-SVC314200800400	Ø80	Ø400	95€



T90° d. conex. 180° SVCH  
d. canaliz.

CÓDIGO	Ø A	Ø B	€
680-SVC313801000300	Ø100	Ø300	141€
680-SVC313801000350	Ø100	Ø350	158€
680-SVC313801000400	Ø100	Ø400	167€
680-SVC313801100250	Ø110	Ø250	130€
680-SVC313801100300	Ø110	Ø300	141€
680-SVC313801100350	Ø110	Ø350	158€
680-SVC313801100400	Ø110	Ø400	167€
680-SVC313801300250	Ø130	Ø250	130€
680-SVC313801300300	Ø130	Ø300	141€
680-SVC313801300350	Ø130	Ø350	158€
680-SVC313801300400	Ø130	Ø400	167€
680-SVC313801500250	Ø150	Ø250	130€
680-SVC313801500300	Ø150	Ø300	141€
680-SVC313801500350	Ø150	Ø350	158€
680-SVC313801500400	Ø150	Ø400	167€
680-SVC313800800250	Ø80	Ø250	130€
680-SVC313800800300	Ø80	Ø300	141€
680-SVC313800800350	Ø80	Ø350	158€
680-SVC313800800400	Ø80	Ø400	167€



T90° d. conex. 90° helic.

CÓDIGO	Ø A	Ø B	€
680-SVC312801000200	Ø100	Ø200	61€
680-SVC312801000250	Ø100	Ø250	71€
680-SVC312801000300	Ø100	Ø300	83€
680-SVC312801000350	Ø100	Ø350	92€
680-SVC312801000400	Ø100	Ø400	95€
680-SVC312801250250	Ø125	Ø250	71€
680-SVC312801250300	Ø125	Ø300	83€
680-SVC312801250350	Ø125	Ø350	92€
680-SVC312801250400	Ø125	Ø400	95€
680-SVC312801500250	Ø150	Ø250	71€
680-SVC312801500300	Ø150	Ø300	83€
680-SVC312801500350	Ø150	Ø350	92€
680-SVC312801500400	Ø150	Ø400	95€
680-SVC312800800150	Ø80	Ø150	55€
680-SVC312800800180	Ø80	Ø180	59€
680-SVC312800800200	Ø80	Ø200	61€
680-SVC312800800250	Ø80	Ø250	71€
680-SVC312800800300	Ø80	Ø300	83€
680-SVC312800800350	Ø80	Ø350	92€
680-SVC312800800400	Ø80	Ø400	95€



T90° conex SVC3 canaliz.

CÓDIGO	Ø A	Ø B	€
680-SVC313301300180	Ø130	Ø180	90€
680-SVC313301300200	Ø130	Ø200	95€
680-SVC313301300250	Ø130	Ø250	106€
680-SVC313301300300	Ø130	Ø300	131€
680-SVC313301300350	Ø130	Ø350	138€
680-SVC313301300400	Ø130	Ø400	145€
680-SVC313301500180	Ø150	Ø180	90€
680-SVC313301500200	Ø150	Ø200	95€
680-SVC313301500250	Ø150	Ø250	106€
680-SVC313301500300	Ø150	Ø300	131€
680-SVC313301500350	Ø150	Ø350	138€
680-SVC313301500400	Ø150	Ø400	145€



Adaptador a silenciador  
H-H



Adaptador a extractor H-H



Collarín antitormenta

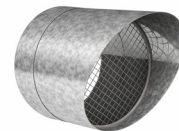

Terminal horizontal con  
rejilla

Ø150	680-SVC3109401500150	12.09€	Ø150	680-SVC3109501500150	12.09€	Ø130	665-ZUWA3070130	29.27€	Ø130	680-SVC35320130	60€
Ø150	680-SVC3109401800150	24.5€	Ø150	680-SVC3109501250150	23.47€	Ø150	665-ZUWA3070150	34.15€	Ø150	680-SVC35320150	76€
Ø200	680-SVC3109401800200	25.46€	Ø200	680-SVC3109502000200	12.98€	Ø180	665-ZUWA3070180	40.87€	Ø180	680-SVC35320180	92€
Ø200	680-SVC3109402000200	14.64€	Ø200	680-SVC3109502500200	26.74€	Ø200	665-ZUWA3070200	47.13€	Ø200	680-SVC35320200	102€
Ø200	680-SVC3109402500200	26.74€	Ø200	680-SVC3109503150200	28.01€	Ø250	665-ZUWA3070250	59€	Ø250	680-SVC35320250	130€
Ø250	680-SVC3109402500250	15.44€	Ø250	680-SVC3109502500250	15.44€	Ø300	665-ZUWA3070300	71€	Ø300	680-SVC35320300	151€
Ø250	680-SVC3109403000250	28.64€	Ø250	680-SVC3109501600250	25.86€	Ø350	665-ZUWA3070350	77€	Ø350	680-SVC35320350	167€
			Ø250	680-SVC3109502000250	26.74€	Ø400	665-ZUWA3070400	83€	Ø400	680-SVC35320400	187€
			Ø250	680-SVC3109503150250	28.96€						
			Ø300	680-SVC3109503150300	16.32€						



T90° d. conex. 90° SVC3

CÓDIGO	Ø A	Ø B	€
680-SVC312901300300	Ø130	Ø300	83€
680-SVC312901300350	Ø130	Ø350	92€
680-SVC312901300400	Ø130	Ø400	95€
680-SVC312901500250	Ø150	Ø250	71€
680-SVC312901500300	Ø150	Ø300	83€
680-SVC312901500350	Ø150	Ø350	92€
680-SVC312901500400	Ø150	Ø400	95€



T90° d. conex. 90° SVCH

CÓDIGO	Ø A	Ø B	€
680-SVC313001000200	Ø100	Ø200	61€
680-SVC313001000250	Ø100	Ø250	71€
680-SVC313001000300	Ø100	Ø300	83€
680-SVC313001000350	Ø100	Ø350	92€
680-SVC313001000400	Ø100	Ø400	95€
680-SVC313001100200	Ø110	Ø200	61€
680-SVC313001100250	Ø110	Ø250	71€
680-SVC313001100300	Ø110	Ø300	83€
680-SVC313001100350	Ø110	Ø350	92€
680-SVC313001100400	Ø110	Ø400	95€
680-SVC313001300250	Ø130	Ø250	71€
680-SVC313001300300	Ø130	Ø300	83€
680-SVC313001300350	Ø130	Ø350	92€
680-SVC313001300400	Ø130	Ø400	95€
680-SVC313001500250	Ø150	Ø250	71€
680-SVC313001500300	Ø150	Ø300	83€
680-SVC313001500350	Ø150	Ø350	92€
680-SVC313001500400	Ø150	Ø400	95€
680-SVC313000800150	Ø80	Ø150	55€
680-SVC313000800180	Ø80	Ø180	59€
680-SVC313000800200	Ø80	Ø200	61€
680-SVC313000800250	Ø80	Ø250	71€
680-SVC313000800300	Ø80	Ø300	83€
680-SVC313000800350	Ø80	Ø350	92€
680-SVC313000800400	Ø80	Ø400	95€



Terminal antiviento galva



Terminal antilluvia galva



Tapa inferior



Tapa inferior con desagüe



Manguito hembra-hembra

Ø130	680-SVC3980130	109€	Ø130	680-SVC3970130	78€	Ø130	680-SVC3940130	29.16€	Ø130	680-SVC3950130	38.57€	Ø130	680-SVC36130130	8.47€
Ø150	680-SVC3980150	137€	Ø150	680-SVC3970150	96€	Ø150	680-SVC3940150	29.16€	Ø150	680-SVC3950150	43.02€	Ø150	680-SVC36130150	8.97€
Ø180	680-SVC3980180	164€	Ø180	680-SVC3970180	116€	Ø180	680-SVC3940180	30.69€	Ø180	680-SVC3950180	45.98€	Ø180	680-SVC36130180	9.29€
Ø200	680-SVC3980200	190€	Ø200	680-SVC3970200	133€	Ø200	680-SVC3940200	36.85€	Ø200	680-SVC3950200	50€	Ø200	680-SVC36130200	9.86€
Ø250	680-SVC3980250	240€	Ø250	680-SVC3970250	165€	Ø250	680-SVC3940250	48.96€	Ø250	680-SVC3950250	63€	Ø250	680-SVC36130250	11.53€
Ø300	680-SVC3980300	285€	Ø300	680-SVC3970300	199€	Ø300	680-SVC3940300	62€	Ø300	680-SVC3950300	79€	Ø300	680-SVC36130300	14.24€
Ø350	680-SVC3980350	346€	Ø350	680-SVC3970350	216€	Ø350	680-SVC3940350	81€	Ø350	680-SVC3950350	98€	Ø350	680-SVC36130350	15.67€
Ø400	680-SVC3980400	380€	Ø400	680-SVC3970400	240€	Ø400	680-SVC3940400	123€	Ø400	680-SVC3950400	164€	Ø400	680-SVC36130400	17.91€



Colector-Adaptador con desagüe



Manguito de unión  
(Hembra EW-Eco y  
Hembra SVC3)



Manguito de unión  
(Hembra EW-Eco y Macho  
SVC3)

CÓDIGO	Ø A	Ø B	€
680-SVC3442601000200	Ø100	Ø200	134€
680-SVC3442601000250	Ø100	Ø250	155€
680-SVC3442601000300	Ø100	Ø300	174€
680-SVC3442601000350	Ø100	Ø350	186€
680-SVC3442601000400	Ø100	Ø400	208€
680-SVC3442601250180	Ø125	Ø180	135€
680-SVC3442601250200	Ø125	Ø200	141€
680-SVC3442601250250	Ø125	Ø250	164€
680-SVC3442601250300	Ø125	Ø300	180€
680-SVC3442601250350	Ø125	Ø350	197€
680-SVC3442601250400	Ø125	Ø400	213€
680-SVC3442600800180	Ø80	Ø180	122€
680-SVC3442600800200	Ø80	Ø200	129€
680-SVC3442600800250	Ø80	Ø250	150€
680-SVC3442600800300	Ø80	Ø300	170€
680-SVC3442600800350	Ø80	Ø350	182€
680-SVC3442600800400	Ø80	Ø400	204€

Ø130	680-SVC396H0130	10.17€	Ø130	680-SVC3960130	10.17€
Ø150	680-SVC396H0150	12.7€	Ø150	680-SVC3960150	12.7€
Ø180	680-SVC396H0180	13.61€	Ø180	680-SVC3960180	13.61€
Ø200	680-SVC396H0200	15.55€	Ø200	680-SVC3960200	15.55€
Ø250	680-SVC396H0250	20.54€	Ø250	680-SVC3960250	20.54€
Ø300	680-SVC396H0300	24.32€	Ø300	680-SVC3960300	24.32€
Ø350	680-SVC396H0350	29.12€	Ø350	680-SVC3960350	29.12€
Ø400	680-SVC396H0400	29.73€	Ø400	680-SVC3960400	29.73€



Abrazadera forjado isofónica galvanizada



Abrazadera isofónica M-8



Abrazadera pared regulable galvanizada



Abrazadera vientos



Base de abrazadera distanciadora

Ø130	665-ZUWA62DB0130	21.25€	Ø130	665-ZUWA1063DB0130	6.56€	Ø130	AQ4-ZUWA900130	21.25€	Ø130	AQ4-ZUWA420130	9.11€	Ø130	AQ4-ZUWA14620130	35.4€
Ø150	665-ZUWA62DB0150	22.2€	Ø150	665-ZUWA1063DB0150	6.56€	Ø150	AQ4-ZUWA900150	22.2€	Ø150	AQ4-ZUWA420150	11.72€	Ø150	AQ4-ZUWA14620150	37.83€
Ø180	665-ZUWA62DB0180	23.68€	Ø180	665-ZUWA1063DB0180	11.38€	Ø180	AQ4-ZUWA900180	23.68€	Ø180	AQ4-ZUWA420180	16.92€	Ø180	AQ4-ZUWA14620180	40.29€
Ø200	665-ZUWA62DB0200	24.7€	Ø200	665-ZUWA1063DB0200	14.65€	Ø200	AQ4-ZUWA900200	24.7€	Ø200	AQ4-ZUWA420200	20.83€	Ø200	AQ4-ZUWA14620200	44.14€
Ø250	665-ZUWA62DB0250	27.19€	Ø250	665-ZUWA1063DB0250	17.9€	Ø250	AQ4-ZUWA900250	27.19€	Ø250	AQ4-ZUWA420250	23.41€	Ø250	AQ4-ZUWA14620250	77€
Ø300	665-ZUWA62DB0300	32.87€	Ø300	665-ZUWA1063DB0300	19.51€	Ø300	AQ4-ZUWA900300	32.87€	Ø300	AQ4-ZUWA420300	27.32€	Ø300	AQ4-ZUWA14620300	107€
Ø350	665-ZUWA62DB0350	35.62€	Ø350	665-ZUWA1063DB0350	32.52€	Ø350	AQ4-ZUWA900350	35.62€	Ø350	AQ4-ZUWA420350	29.94€	Ø350	AQ4-ZUWA14620350	144€
Ø400	665-ZUWA62DB0400	38.4€	Ø400	665-ZUWA1063DB0400	39.04€	Ø400	AQ4-ZUWA900400	38.4€	Ø400	AQ4-ZUWA420400	32.69€	Ø400	AQ4-ZUWA14620400	186€



Alas distanciadoras A



Alas distanciadoras B



Alas distanciadoras C



Alas distanciadoras D

Ø130	AQ4-ZUWA1462A	37.71€	Ø130	AQ4-ZUWA1462B	52€	Ø130	AQ4-ZUWA1462C	66	Ø130	AQ4-ZUWA1462D	82€
Ø150	AQ4-ZUWA1462A	37.71€	Ø150	AQ4-ZUWA1462B	52€	Ø150	AQ4-ZUWA1462C	66	Ø150	AQ4-ZUWA1462D	82€
Ø180	AQ4-ZUWA1462A	37.71€	Ø180	AQ4-ZUWA1462B	52€	Ø180	AQ4-ZUWA1462C	66	Ø180	AQ4-ZUWA1462D	82€
Ø200	AQ4-ZUWA1462A	37.71€	Ø200	AQ4-ZUWA1462B	52€	Ø200	AQ4-ZUWA1462C	66	Ø200	AQ4-ZUWA1462D	82€
Ø250	AQ4-ZUWA1462A	37.71€	Ø250	AQ4-ZUWA1462B	52€	Ø250	AQ4-ZUWA1462C	66	Ø250	AQ4-ZUWA1462D	82€
Ø300	AQ4-ZUWA1462A	37.71€	Ø300	AQ4-ZUWA1462B	52€	Ø300	AQ4-ZUWA1462C	66	Ø300	AQ4-ZUWA1462D	82€
Ø350	AQ4-ZUWA1462A	37.71€	Ø350	AQ4-ZUWA1462B	52€	Ø350	AQ4-ZUWA1462C	66	Ø350	AQ4-ZUWA1462D	82€
Ø400	AQ4-ZUWA1462A	37.71€	Ø400	AQ4-ZUWA1462B	52€	Ø400	AQ4-ZUWA1462C	66	Ø400	AQ4-ZUWA1462D	82€

## CONDUCTO SVC-4



Módulo recto 1000mm



Módulo recto 500mm



Módulo recto 1000mm con canalización interior



Módulo recto 1000mm con doble canalización int.



Módulo recto regulable 860-1420mm

Ø180	685-SVC49090180	76€	Ø180	685-SVC49100180	44.25€	Ø180	685-SVC4130180	117€	Ø250	685-SVC49970250	213€	Ø180	685-SVC45400180	173€
Ø200	685-SVC49090200	82€	Ø200	685-SVC49100200	50€	Ø200	685-SVC4130200	129€	Ø300	685-SVC49970300	242€	Ø200	685-SVC45400200	184€
Ø250	685-SVC49090250	101€	Ø250	685-SVC49100250	60€	Ø250	685-SVC4130250	151€	Ø350	685-SVC49970350	291€	Ø250	685-SVC45400250	224€
Ø300	685-SVC49090300	117€	Ø300	685-SVC49100300	71€	Ø300	685-SVC4130300	176€	Ø400	685-SVC49970400	327€	Ø300	685-SVC45400300	259€
Ø350	685-SVC49090350	156€	Ø350	685-SVC49100350	93€	Ø350	685-SVC4130350	220€				Ø350	685-SVC45400350	334€
Ø400	685-SVC49090400	178€	Ø400	685-SVC49100400	101€	Ø400	685-SVC4130400	245€				Ø400	685-SVC45400400	375€



Módulo recto reg. 860-1420mm con canaliz. int.



Módulo recto reg. 860-1420mm con canaliz. int. 90°



Codo 45°



Codo 90°



Te 90° conexión Ø130mm

Ø180	685-SVC4542L0180	194€	Ø250	685-SVC443610250	318€	Ø180	685-SVC4180180	47.3€	Ø180	685-SVC4600180	72€	Ø180	685-SVC4902H0180	129€
Ø200	685-SVC4542L0200	213€	Ø300	685-SVC443610300	364€	Ø200	685-SVC4180200	54€	Ø200	685-SVC4600200	85€	Ø200	685-SVC4902H0200	141€
Ø250	685-SVC4542L0250	252€	Ø350	685-SVC443610350	453€	Ø250	685-SVC4180250	74€	Ø250	685-SVC4600250	96€	Ø250	685-SVC4902H0250	172€
Ø300	685-SVC4542L0300	287€	Ø400	685-SVC443610400	502€	Ø300	685-SVC4180300	82€	Ø300	685-SVC4600300	148€	Ø300	685-SVC4902H0300	198€
Ø350	685-SVC4542L0350	369€				Ø350	685-SVC4180350	107€	Ø350	685-SVC4600350	196€	Ø350	685-SVC4902H0350	229€
Ø400	685-SVC4542L0400	415€				Ø400	685-SVC4180400	117€	Ø400	685-SVC4600400	214€	Ø400	685-SVC4902H0400	261€



Te 90° conexión doble Ø130mm a 180°



Te 90° conexión Ø130mm con canalización interior



Te 90° conex. doble Ø130 a 180° doble canalización

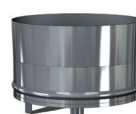

Tapa inferior con desagüe

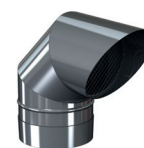

Terminal a 93° con rejilla

Ø180	685-SVC4899H0180	158€	Ø180	685-SVC43170180	163€	Ø250	685-SVC4584H0250	263€	Ø180	685-SVC4950180	137€	Ø180	685-SVC443600180	119€
Ø200	685-SVC4899H0200	169€	Ø200	685-SVC43170200	177€	Ø300	685-SVC4584H0300	295€	Ø200	685-SVC4950200	146€	Ø200	685-SVC443600200	139€
Ø250	685-SVC4899H0250	198€	Ø250	685-SVC43170250	210€	Ø350	685-SVC4584H0350	344€	Ø250	685-SVC4950250	174€	Ø250	685-SVC443600250	161€
Ø300	685-SVC4899H0300	228€	Ø300	685-SVC43170300	239€	Ø400	685-SVC4584H0400	376€	Ø300	685-SVC4950300	201€	Ø300	685-SVC443600300	182€
Ø350	685-SVC4899H0350	263€	Ø350	685-SVC43170350	271€				Ø350	685-SVC4950350	228€	Ø350	685-SVC443600350	232€
Ø400	685-SVC4899H0400	296€	Ø400	685-SVC43170400	304€				Ø400	685-SVC4950400	256€	Ø400	685-SVC443600400	256€
			Ø180	685-SVC4317H0180	158€									
			Ø200	685-SVC4317H0200	172€									
			Ø250	685-SVC4317H0250	204€									
			Ø300	685-SVC4317H0300	232€									
			Ø350	685-SVC4317H0350	263€									
			Ø400	685-SVC4317H0400	295€									

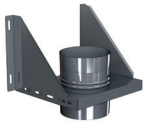

Soporte de carga regulable

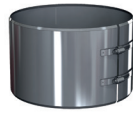

Abrazadera de unión EWKL



Base de abrazadera distanciadora



Alas distanciadoras A



Alas distanciadoras B

Ø180	685-SVC43790180	108€	Ø180	665-ZUWA45KL0180	30€	Ø180	665-ZUWA14620180	52€	Ø180	665-ZUWA1462A	47.13€	Ø180	665-ZUWA1462B	65€
Ø200	685-SVC43790200	125€	Ø200	665-ZUWA45KL0200	33.16€	Ø200	665-ZUWA14620200	58€	Ø200	665-ZUWA1462A	47.13€	Ø200	665-ZUWA1462B	65€
Ø250	685-SVC43790250	156€	Ø250	665-ZUWA45KL0250	47.3€	Ø250	665-ZUWA14620250	100€	Ø250	665-ZUWA1462A	47.13€	Ø250	665-ZUWA1462B	65€
Ø300	685-SVC43790300	185€	Ø300	665-ZUWA45KL0300	57€	Ø300	665-ZUWA14620300	138€	Ø300	665-ZUWA1462A	47.13€	Ø300	665-ZUWA1462B	65€
Ø350	685-SVC43790350	205€	Ø350	665-ZUWA45KL0350	64€	Ø350	665-ZUWA14620350	185€	Ø350	665-ZUWA1462A	47.13€	Ø350	665-ZUWA1462B	65€
Ø400	685-SVC43790400	227€	Ø400	665-ZUWA45KL0400	82€	Ø400	665-ZUWA14620400	241€	Ø400	665-ZUWA1462A	47.13€	Ø400	665-ZUWA1462B	65€



Alas distanciadoras C



Alas distanciadoras D



Abrazadera fijación pared regulable 50-80mm



Abrazadera de soporte



Abrazadera con doble pértiga telescópica L=2000mm

Ø180	665-ZUWA1462C	81€	Ø180	665-ZUWA1462D	104€	Ø180	665-ZUWA5560180	39.04€	Ø180	665-ZUWA8580180	145€	Ø180	665-ZUWA1910180	156€
Ø200	665-ZUWA1462C	81€	Ø200	665-ZUWA1462D	104€	Ø200	665-ZUWA5560200	45.58€	Ø200	665-ZUWA8580200	145€	Ø200	665-ZUWA1910200	173€
Ø250	665-ZUWA1462C	81€	Ø250	665-ZUWA1462D	104€	Ø250	665-ZUWA5560250	61€	Ø250	665-ZUWA8580250	185€	Ø250	665-ZUWA1910250	196€
Ø300	665-ZUWA1462C	81€	Ø300	665-ZUWA1462D	104€	Ø300	665-ZUWA5560300	64€	Ø300	665-ZUWA8580300	203€	Ø300	665-ZUWA1910300	233€
Ø350	665-ZUWA1462C	81€	Ø350	665-ZUWA1462D	104€	Ø350	665-ZUWA5560350	67€	Ø350	665-ZUWA8580350	221€	Ø350	665-ZUWA1910350	249€
Ø400	665-ZUWA1462C	81€	Ø400	665-ZUWA1462D	104€	Ø400	665-ZUWA5560400	88€	Ø400	665-ZUWA8580400	270€	Ø400	665-ZUWA1910400	272€



Abrazadera vientos



Collarín antitormenta



Abrazadera para amarre por tornillo



Pasamuros

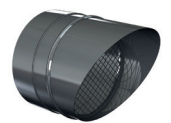

Terminal horizontal con rejilla

Ø180	665-ZUWA420180	21.16€	Ø180	665-ZUWA3070180	40.87€	Ø180	665-ZUWA10630180	39.04€	Ø180	665-ZUWA9870180	52€	Ø180	685-SVC45320180	59€
Ø200	665-ZUWA420200	26.04€	Ø200	665-ZUWA3070200	47.13€	Ø200	665-ZUWA10630200	42.42€	Ø200	665-ZUWA9870200	52€	Ø200	685-SVC45320200	64€
Ø250	665-ZUWA420250	29.27€	Ø250	665-ZUWA3070250	59€	Ø250	665-ZUWA10630250	50€	Ø250	665-ZUWA9870250	65€	Ø250	685-SVC45320250	83€
Ø300	665-ZUWA420300	34.15€	Ø300	665-ZUWA3070300	71€	Ø300	665-ZUWA10630300	65€	Ø300	665-ZUWA9870300	83€	Ø300	685-SVC45320300	104€
Ø350	665-ZUWA420350	37.43€	Ø350	665-ZUWA3070350	77€	Ø350	665-ZUWA10630350	74€	Ø350	665-ZUWA9870350	95€	Ø350	685-SVC45320350	129€
Ø400	665-ZUWA420400	40.87€	Ø400	665-ZUWA3070400	83€	Ø400	665-ZUWA10630400	84€	Ø400	665-ZUWA9870400	121€	Ø400	685-SVC45320400	144€



Te 90° con. doble Ø125mm a 90° doble canal. int.

Te 90° con. doble Ø130mm a 90° doble canal. int.

Te 90° conex. doble Ø125 a 180° doble canalización

Te 90° conexión doble Ø125mm a 180°

Te 90° conexión Ø125mm

Ø250	685-SVC443620250	271€	Ø250	685-SVC44362H0250	271€	Ø250	685-SVC45840250	271€	Ø180	685-SVC48990180	163€	Ø180	685-SVC49020180	133€
Ø300	685-SVC443620300	304€	Ø300	685-SVC44362H0300	304€	Ø300	685-SVC45840300	304€	Ø200	685-SVC48990200	174€	Ø200	685-SVC49020200	145€
Ø350	685-SVC443620350	354€	Ø350	685-SVC44362H0350	354€	Ø350	685-SVC45840350	354€	Ø250	685-SVC48990250	204€	Ø250	685-SVC49020250	177€
Ø400	685-SVC443620400	387€	Ø400	685-SVC44362H0400	387€	Ø400	685-SVC45840400	387€	Ø300	685-SVC48990300	235€	Ø300	685-SVC49020300	204€
									Ø350	685-SVC48990350	271€	Ø350	685-SVC49020350	236€
									Ø400	685-SVC48990400	305€	Ø400	685-SVC49020400	269€



Te 90° doble conexión a 90° EW-ECO Ø130

Te 90° doble conexión a 90° Ø125

Módulo recto reg. 860-1420mm doble canaliz. int.

Módulo recto 250mm

Módulo recto 1000mm con doble canaliz. int. a 90°

Ø250	685-SVC41469H0250	204€	Ø250	685-SVC41469O250	204€	Ø250	685-SVC4998L0250	309€	Ø180	685-SVC49120180	30.9€	Ø250	685-SVC443590250	219€
Ø300	685-SVC41469H0300	235€	Ø300	685-SVC41469O300	235€	Ø300	685-SVC4998L0300	353€	Ø200	685-SVC49120200	34.15€	Ø300	685-SVC443590300	249€
Ø350	685-SVC41469H0350	271€	Ø350	685-SVC41469O350	271€	Ø350	685-SVC4998L0350	440€	Ø250	685-SVC49120250	39.04€	Ø350	685-SVC443590350	300€
Ø400	685-SVC41469H0400	305€	Ø400	685-SVC41469O400	305€	Ø400	685-SVC4998L0400	487€	Ø300	685-SVC49120300	47.13€	Ø400	685-SVC443590400	337€
									Ø350	685-SVC49120350	59€			
									Ø400	685-SVC49120400	64€			



# BAJANTES DE ROPA Y RSU

Instalaciones  
de traslado por  
gravedad de ropa y  
residuos ordinarios

# 269

# ¿Qué es el sistema Clean Duct Pro?

## MÁS QUE UN CONDUCTO...

Clean Duct Pro es un sistema de Bajantes de Ropa y Residuos Sólidos Urbanos (RSU) fabricado en acero inoxidable y utilizado en edificios para la recogida de ropa sucia y residuos.



**Transporta** la ropa sucia de manera eficiente.



**Evita el trasiego en carros** por montacargas y ascensores.



**Optimiza el tiempo** de los empleados.



**Garantiza una mayor higiene** en el entorno.



Cuenta con compuertas de acceso que cumplen con requisitos de **resistencia al fuego y seguridad**.

## NOVEDAD



### SyncDuct



Ofrece la posibilidad de instalar un sistema de **conexión inalámbrico** con enclavamiento eléctrico incluido.



# Sistema Clean Duct Pro



## ASPIRADOR ESTÁTICO

Terminales que permiten la correcta ventilación de todo el sistema eliminando posibles olores que puedan provocar los residuos que transcurren por el conducto. Incluye una toma de agua con racor y una compuerta para limpieza.

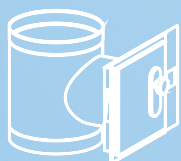

## COMPUERTA DE VERTIDO

Registros de acceso al conducto vertical de, dispuestos en cada planta para permitir la introducción y evacuación del material hacia el sistema de bajantes. Con resistencia al fuego EI60.



## CODO 15°

Leve desviación del conducto necesaria para evitar los ruidos producidos por una velocidad excesiva en la caída de los residuos.



## CIERRE CONTRAPESADO

Cierre mecánico que frena la caída de los elementos que discurren por el conducto para la seguridad de los usuarios y del propio sistema.



## CLEAN DUCT PRO



Módulo recto 1000mm



Módulo recto 500mm



Módulo recto 250mm



Módulo recto regulable  
560-920mm

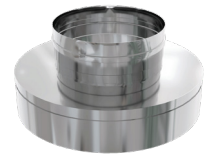

Reducción a EW-ECO  
Ø200

Ø450	AH3-EWEC130450	276€	Ø450	AH3-EWEC140450	190€	Ø450	AH3-EWEC150450	114€	Ø450	AH3-EWEC5450450	479€	Ø450	AH3-EWEC3370450	436€
Ø500	AH3-EWEC130500	353€	Ø500	AH3-EWEC140500	239€	Ø500	AH3-EWEC150500	156€	Ø500	AH3-EWEC5450500	535€	Ø500	AH3-EWEC3370500	558€
Ø550	AH3-EWEC130550	483€	Ø550	AH3-EWEC140550	277€	Ø550	AH3-EWEC150550	177€	Ø550	AH3-EWEC5450550	588€	Ø550	AH3-EWEC3370550	763€
Ø600	AH3-EWEC130600	512€	Ø600	AH3-EWEC140600	293€	Ø600	AH3-EWEC150600	197€	Ø600	AH3-EWEC5450600	645€	Ø600	AH3-EWEC3370600	810€
Ø650	AH3-EWEC130650	547€	Ø650	AH3-EWEC140650	311€	Ø650	AH3-EWEC150650	206€	Ø650	AH3-EWEC5450650	686€	Ø650	AH3-EWEC3370650	864€
Ø700	AH3-EWEC130700	680€	Ø700	AH3-EWEC140700	383€	Ø700	AH3-EWEC150700	256€	Ø700	AH3-EWEC5450700	852€	Ø700	AH3-EWEC3370700	1073€
Ø750	AH3-EWEC130750	708€	Ø750	AH3-EWEC140750	403€	Ø750	AH3-EWEC150750	268€	Ø750	AH3-EWEC5450750	893€	Ø750	AH3-EWEC3370750	1118€



Soporte de carga bajantes



Te de entrada bajantes  
boca Ø300



Te de entrada bajantes  
boca Ø350



Te de entrada bajantes  
boca Ø400



Te entrada bajantes boca  
corta Ø300

Ø450	AH3-EWEC3330450	503€	Ø450	AH3-EWEC9490450	832€	Ø450	AH3-EWEC3540450	903€	Ø450	AH3-EWEC3060450	969€	Ø450	AH3-EWEC3260450	769€
Ø500	AH3-EWEC3330500	707€	Ø500	AH3-EWEC9490500	1085€	Ø500	AH3-EWEC3540500	1156€	Ø500	AH3-EWEC3060500	1223€	Ø500	AH3-EWEC3260500	1002€
Ø550	AH3-EWEC3330550	1022€	Ø550	AH3-EWEC9490550	1591€	Ø550	AH3-EWEC3540550	1662€	Ø550	AH3-EWEC3060550	1729€	Ø550	AH3-EWEC3260550	1472€
Ø600	AH3-EWEC3330600	1069€	Ø600	AH3-EWEC9490600	1636€	Ø600	AH3-EWEC3540600	1707€	Ø600	AH3-EWEC3060600	1774€	Ø600	AH3-EWEC3260600	1514€
Ø650	AH3-EWEC3330650	1134€	Ø650	AH3-EWEC9490650	1748€	Ø650	AH3-EWEC3540650	1819€	Ø650	AH3-EWEC3060650	1886€	Ø650	AH3-EWEC3260650	1617€
Ø700	AH3-EWEC3330700	1405€	Ø700	AH3-EWEC9490700	2171€	Ø700	AH3-EWEC3540700	2242€	Ø700	AH3-EWEC3060700	2309€	Ø700	AH3-EWEC3260700	2009€
Ø750	AH3-EWEC3330750	1473€	Ø750	AH3-EWEC9490750	2262€	Ø750	AH3-EWEC3540750	2333€	Ø750	AH3-EWEC3060750	2400€	Ø750	AH3-EWEC3260750	2092€



Te entrada bajantes boca  
corta Ø350



Te entrada bajantes boca  
corta Ø400



Puerta bajante EI60 con  
enclavamiento  
400x400mm



Puerta bajante EI60  
400x400mm



Módulo de inspección con  
conexión para manguera

Ø450	AH3-EWEC3550450	836€	Ø450	AH3-EWEC3560450	896€	000-DRWG1395N0001	2273€	Ø0	000-DRWG1394N0001	1066€	Ø200	670-EWEC3740200	244€
Ø500	AH3-EWEC3550500	1069€	Ø500	AH3-EWEC3560500	1130€								
Ø550	AH3-EWEC3550550	1539€	Ø550	AH3-EWEC3560550	1599€								
Ø600	AH3-EWEC3550600	1581€	Ø600	AH3-EWEC3560600	1641€								
Ø650	AH3-EWEC3550650	1684€	Ø650	AH3-EWEC3560650	1744€								
Ø700	AH3-EWEC3550700	2075€	Ø700	AH3-EWEC3560700	2135€								
Ø750	AH3-EWEC3550750	2159€	Ø750	AH3-EWEC3560750	2220€								



Adaptador puerta bajante

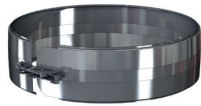

Abrazadera de unión 2.0



Módulo recto 1000mm

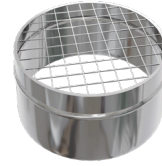

Terminal salida libre con rejilla 24x24mm



Terminal GAS light

Ø300	AH3-EWEC13900300	138€	Ø450	665-ZUWA9890450	48.72€	Ø200	670-EWEC130200	80€	Ø200	670-EWEC130200	80€	Ø200	670-EWEC43500200	274€
Ø350	AH3-EWEC13900350	164€	Ø500	665-ZUWA9890500	54€									
Ø400	AH3-EWEC13900400	192€	Ø550	665-ZUWA9890550	58€									
			Ø600	665-ZUWA9890600	66€									
			Ø650	665-ZUWA9890650	73€									
			Ø700	665-ZUWA9890700	84€									
			Ø750	665-ZUWA9890750	100€									



Abrazadera fijación pared fija



Kit cierre contrapesado + abrazadera pared

Ø450	665-ZUWA556F0450	118€	Ø450	AH3-EWEC3360450	2155€
Ø500	665-ZUWA556F0500	123€	Ø500	AH3-EWEC3360500	2235€
Ø550	665-ZUWA556F0550	155€	Ø550	AH3-EWEC3360550	2348€
Ø600	665-ZUWA556F0600	185€	Ø600	AH3-EWEC3360600	2464€
Ø650	665-ZUWA556F0650	203€	Ø650	AH3-EWEC3360650	2573€
Ø700	665-ZUWA556F0700	264€	Ø700	AH3-EWEC3360700	2734€
Ø750	665-ZUWA556F0750	321€	Ø750	AH3-EWEC3360750	2899€



Codo 15° soldado



Codo 45° soldado

Ø450	AH3-EWEC3340450	396€	Ø450	AH3-EWEC1990450	396€
Ø500	AH3-EWEC3340500	555€	Ø500	AH3-EWEC1990500	555€
Ø550	AH3-EWEC3340550	724€	Ø550	AH3-EWEC1990550	724€
Ø600	AH3-EWEC3340600	746€	Ø600	AH3-EWEC1990600	746€
Ø650	AH3-EWEC3340650	797€	Ø650	AH3-EWEC1990650	797€
Ø700	AH3-EWEC3340700	990€	Ø700	AH3-EWEC1990700	990€
Ø750	AH3-EWEC3340750	1031€	Ø750	AH3-EWEC1990750	1031€





Sistema

**Clean Duct**

Home

**Soluciones para  
viviendas unifamiliares**

# Sistema Clean Duct Home

Conducto modular para el traslado por gravedad de ropa y RSU fabricada en acero inoxidable.



## MATERIAL

Acero Inoxidable.

## ACABADO EXTERIOR

Brillante

Colores RAL (según diámetro, consultar precios)

## ESPEORES (mm)

1 mm

## DIÁMETROS DISPONIBLES (mm)

Ø250 mm, Ø285 mm, Ø300 mm

## SISTEMA DE UNIÓN

Conexión macho-hembra con abrazadera de unión sencilla



## APLICACIONES

Bajantes de ropa.  
Bajantes de RSU.



## CARACTERÍSTICAS

**Soldadura TIG/LÁSER** en continuo en todas las piezas.  
Abrazadera de unión **NO INCLUIDA**.  
Posibilidad de **corte de módulos rectos a medida en obra**.

# VARIANTES

**VARIANTE 1**

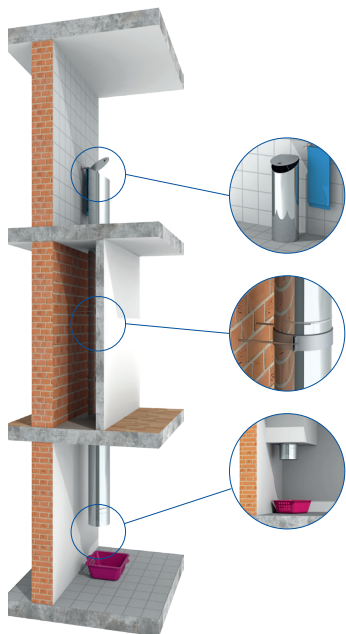

Bajante de ropa con boca de entrada con puerta superior y tubo de recepción con salida libre y bordeado de seguridad en la sala de lavandería.

**2 VARIANTE 2**



Bajante de ropa doméstica con boca de entrada con puerta lateral, puerta adicional en el entrepiso y tubo de recepción con puerta de cierre automático en la sala de lavandería.

**3 VARIANTE 3**

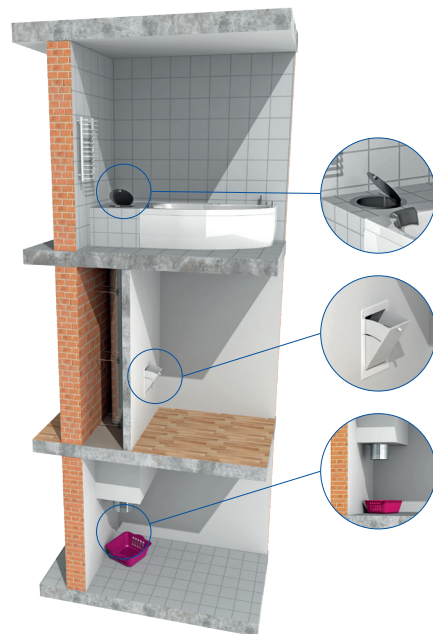

Bajante de ropa doméstica con boca de entrada superior redonda, puerta rectangular integrada con cerradura en el entrepiso y tubo de recepción abierto con bordeado de seguridad en la sala de lavandería.

# ELEMENTOS



Puerta vertical oval con asa H=980mm



Terminal apertura superior H=980mm puerta abatible



Terminal de apertura superior H=980mm

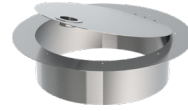

Puerta abatible horizontal redonda



Puerta 340x450mm con cierre lateral - inox

Ø250	412-JERE1458Z0250	1161€	Ø250	412-JERE1750250	678€	Ø250	412-JERE1463Z0250	644€	Ø250	412-JERE1760250	343€	412-JERE54N0001	1316€	
Ø285	412-JERE1458Z0285	1245€	Ø285	412-JERE1750285	759€	Ø285	412-JERE1463Z0285	735€	Ø285	412-JERE1760285	355€			
Ø300	412-JERE1458Z0300	1283€	Ø300	412-JERE1750300	797€	Ø300	412-JERE1463Z0300	827€	Ø300	412-JERE1760300	365€			



Puerta 340x450mm con cierre lateral - blanca



Puerta abatible 340x450 L100mm en blanco



Puerta abatible 340x450 L100mm



Tapa de cierre con asa



Tapa de cierre autodisparante

412-JERE1459ZN0001	1316€	412-JERE177N0001	1272€	412-JERE178N0001	1272€	Ø250	412-JERE2940250	81€	Ø250	412-JERE2920250	308€
						Ø285	412-JERE2940285	81€	Ø285	412-JERE2920285	308€
						Ø300	412-JERE2940300	81€	Ø300	412-JERE2920300	308€



Módulo recto con tapa de autocierre L=323mm



Módulo recto 980mm con puerta para ropa



Soporte de pared incl. varilla roscada M10

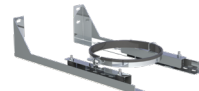

Soporte de carga isofónico



Módulo recto 1000mm

Ø250	412-JERE1461Z0250	354€	Ø250	412-JERE1460Z0250	238€	Ø250	412-JERE2930250	76€	Ø250	412-JERE1462Z0250	122€	Ø250	412-JERE130250	138€
Ø285	412-JERE1461Z0285	374€	Ø285	412-JERE1460Z0285	263€	Ø285	412-JERE2930285	76€	Ø285	412-JERE1462Z0285	135€	Ø285	412-JERE130280	169€
Ø300	412-JERE1461Z0300	381€	Ø300	412-JERE1460Z0300	279€	Ø300	412-JERE2930300	76€	Ø300	412-JERE1462Z0300	147€	Ø300	412-JERE130300	176€



Módulo recto 500mm



Codo 45°

Ø250	412-JERE140250	76€	Ø250	412-JERE180250	119€
Ø285	412-JERE140285	85€	Ø285	412-JERE180285	133€
Ø300	412-JERE140300	91€	Ø300	412-JERE180300	145€





# Herramientas Inteligentes Jeremias

281

# Herramientas inteligentes Jeremias

Jeremias dispone de herramientas de apoyo a ingenieros, prescriptores, arquitectos, personal técnico... En su esfuerzo de innovar y facilitar al cliente los cálculos de instalación y presentación de informes ha desarrollado una serie de programas dependiendo del sistema y el producto.



## ¡Jeremias, el primer fabricante de chimeneas en BIM!

JEREMIAS es el único fabricante de chimeneas que ha conseguido el nivel BIM2 con sus familias de productos.

No solo disponemos de una biblioteca de productos, sino que debido a la complejidad del diseño de nuestro tipo de producto (por el gran número de piezas en cada instalación) hemos desarrollado un plug-in específicamente diseñado para facilitar el desarrollo de proyectos de chimeneas en el entorno de Autodesk Revit.

JEREMIAS refuerza así su vocación por desarrollar las mejores herramientas para facilitar el trabajo a ingenieros y diseñadores de instalaciones en todo lo relacionado con proyectos que incluyan nuestra tipología de producto.

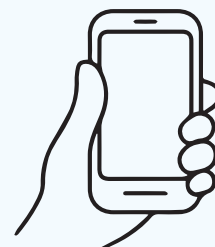

BIM

# VentBOM

El primer y único fabricante de chimeneas de Europa que ofrece a sus clientes un software de diseño de instalaciones específico y gratuito.



**JEREMIAS presenta su nuevo software de diseño VENTBOM, compuesto de una interfaz 3D via web mediante la cual el usuario puede diseñar de una manera extremadamente rápida e intuitiva las instalaciones de chimeneas modulares y conductos resistentes al fuego. El propio software incluye automáticamente los accesorios necesarios según el tipo de instalación y sus normativas aplicables (módulos de inspección, elementos de soporte, abrazaderas de fijación, terminales, etc.), dando también la posibilidad de personalizar completamente todo el despiece de la instalación.**

**Obteniendo de manera automática la oferta con el despiece completo y el esquema técnico detallado de la instalación.**

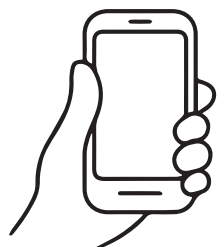

VentBOM

**REGÍSTRATE**

# Easy-calc 6.1

powered by JEREMIAS

JEREMIAS presenta su nueva versión de software de cálculo de chimeneas EASY CALC 6.1.

La nueva aplicación de Jeremias permite, de forma rápida y sencilla, calcular la sección de la chimenea en una instalación de evacuación de humos, cumpliendo con la norma europea de cálculo vigente EN 13384 partes 1 y 2.

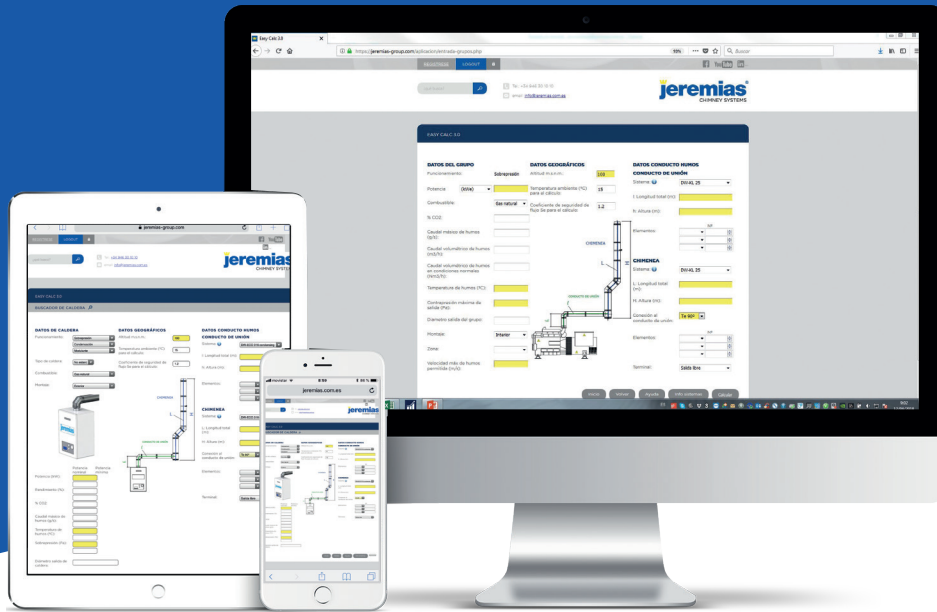

[Enlace al programa](#)



## ✓ ACCESIBILIDAD TOTAL VÍA WEB

Al ser una plataforma de cálculo online incluida en la página web de Jeremias está accesible desde cualquier equipo con conexión a Internet (**PC, portátil, Tablet, móvil...**), sin necesidad de ningún tipo de instalación previa. Además de esta manera se garantiza trabajar siempre con la última versión del software.



## ✓ BASE DE DATOS DE CALDERAS

Es el único software de cálculo comercial que dispone de una base de datos de calderas con todos sus datos técnicos, lo que facilita el cálculo y da garantías de que los datos introducidos son correctos.



## ✓ PLATAFORMA DE GESTIÓN DE PROYECTOS PERSONALIZADA

Al trabajar con usuario y contraseña se da la posibilidad de tener una base de datos de proyectos personalizada para poder acceder a los proyectos hechos en cualquier momento. Dentro de cada proyecto se pueden guardar revisiones cuando haya modificaciones y tener accesibles todas las revisiones anteriores.



## ✓ EXPORTACIÓN DE DATOS A PRESTO

Desde la página de resultados de cálculo se puede exportar -simplemente arrastrando al presupuesto de Presto- la información del proyecto, facilitando así el trabajo de creación de presupuestos.



## ✓ INFORMACIÓN TÉCNICA DE TODOS LOS SISTEMAS

Dentro del software se pueden consultar las fichas técnicas y especificaciones de todos los sistemas de chimeneas disponibles. Además dentro de la zona de descargas de la propia web se puede obtener toda la información de nuestros productos y soluciones.

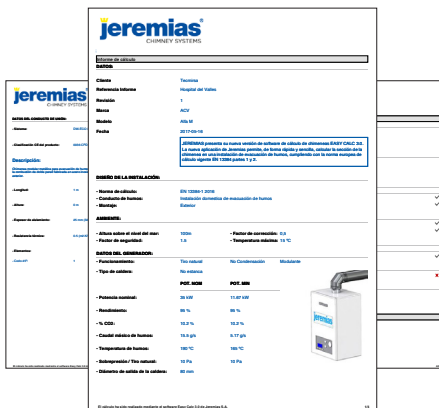

## ✓ INFORMES DE CÁLCULO PERSONALIZADOS EN PDF

Se generan informes de cálculo en PDF para su inclusión en la memoria de los proyectos o en ofertas comerciales. Estos informes se pueden personalizar incluyendo textos explicativos y archivos de imagen como logos, etc.



## ✓ COMPARTIR CÁLCULOS ENTRE USUARIOS

Se ofrece la posibilidad de enviar el cálculo realizado vía mail. De esta forma se facilita la comunicación técnica entre usuarios, así como las posibles consultas con nuestro departamento técnico.

## CÓMO USAR NUESTRO SOFTWARE DE CÁLCULO **EASY-CALC 6.1**

Descubra nuestro software de cálculo Easy-Calc 6.1 a través de nuestra sencilla aplicación que encontrará en la web [www.jeremias.es](http://www.jeremias.es) en el menú SOFTWARE.

<https://easycalc.jeremias-group.com/registro.php>



## GENERAL

La venta y entrega está sujeta a las siguientes condiciones. Cualquier acuerdo colateral, diferencias y seguros requeridos deberán ser confirmados en documento escrito.

Para la formalización expresa de cualquier pedido, es preciso haber recibido en Jeremias dicho pedido por escrito o en su defecto recibir del cliente la confirmación del mismo a través de la firma y sello del documento oficializado como pedido en Jeremias.

Las condiciones de compra del cliente no son objeto de acuerdo incluso en el caso de no oposición expresa a las mismas.

En caso de acuerdo ocasional de condiciones especiales para un pedido en particular, se indicaran en el pedido en cuestión.

En el caso de precisar un pedido de material con diseño y fabricación de piezas especiales, estas deberán de ir acompañadas de un plano o dibujo realizado por el cliente, o en su defecto se requerirá la firma y sello del cliente en señal de conformidad en el plano diseñado por Jeremias.

Estas piezas especiales no serán, en ningún caso, susceptibles de anulación o devolución una vez confirmadas por el cliente.

Las condiciones de pago y entrega son de obligado cumplimiento para todos los contratos debido a las presentes y futuras relaciones comerciales establecidas.



## PRECIOS Y CONDICIONES

Los precios publicados en esta tarifa son precios indicativos para mercancía puesta en fábrica, que sustituyen y anulan todos los anteriormente publicados, y no constituyen oferta alguna por parte de JEREMIAS España, S.A.U.

Los precios en factura serán los que estén en vigor a la fecha de la entrega del material.

Impuestos no incluidos en los precios publicados en la tarifa.

El precio y pago serán concretados en cada caso por las partes y confirmados por escrito.



## TRANSPORTE

JEREMIAS España, S.A.U. no emitirá cargos logísticos a expediciones de importe neto superior a 1.000€ en península y 2.500€ en Canarias, Baleares, Ceuta, Melilla y Portugal.

En el caso de que el importe del pedido fuera inferior a lo arriba detallado, el cliente deberá informar a JEREMIAS España, S.A.U. la agencia de transporte susceptible de su interés para la realización del envío y se remitirá el material a portes debidos o se cargarán en factura. En su defecto JEREMIAS España, S.A.U. se reserva el derecho a enviar los pedidos por su agencia habitual incluyendo en la factura del cliente los portes de dicha expedición.

Si la entrega del material debe realizarse en una obra en concreto, será el cliente quien deberá tomar las medidas oportunas a fin de garantizar la correcta recepción de la mercancía y la óptima y rápida localización del lugar de entrega de cara al transportista.

En caso de producirse estancias prolongadas del material en las naves del operador logístico y/o inmovilización de vehículos, los costes derivados deberán ser asumidos por el cliente.



## RESERVA DE LA PROPIEDAD

La entrega de material se realiza con las siguientes reservas:

Toda la mercancía servida al cliente o dirección de envío requerida, es propiedad exclusiva de JEREMIAS España, S.A.U. hasta que no haya sido cobrada en su totalidad, acorde a la factura emitida.

La reserva de la propiedad es un seguro de cara a las facturas en curso. En caso de incumplimiento de pago por parte del cliente en las condiciones de pago acordadas, JEREMIAS España, S.A.U. tendrá el derecho de suspender las entregas pendientes, así como anular los pedidos en curso de dicho cliente.



## RESERVA DE DOMINIO

La venta de los bienes se realiza con reserva de dominio a favor de Jeremias España S.A. hasta el pago íntegro de su precio en las condiciones establecidas. En caso contrario, el vendedor tendrá derecho a retirar el material adquirido en cualquier momento. La aceptación de ofertas por el cliente supone la entrada en vigor de la misma con carácter de contrato, con las consiguientes obligaciones para con Jeremias España S.A.U. y para con el cliente aceptante.



## ENVÍO Y PELIGRO DE TRANSICIÓN

Se recomienda al cliente la comprobación del perfecto estado de los precintos, embalajes y material al retirar el pedido del transportista. En caso de anomalía alguna se deberá remitir notificación escrita a JEREMIAS España, S.A.U. en el **plazo máximo de 24 horas** desde la recepción del material, así como notificarlo en el albarán del transportista, o al menos firmarlo con reservas. A partir de este plazo, JEREMIAS España, S.A.U. no se responsabilizará de posibles incidencias futuras.

Las reclamaciones por falta de material serán únicamente aceptadas a trámite cuando se notifiquen por escrito a JEREMIAS España, S.A.U. en el plazo máximo de 24 horas desde la recepción del material.

No se admiten devoluciones de las piezas especiales fabricadas bajo pedido. Todas las reclamaciones susceptibles de cambio, reparación de material o devolución deberán ser obligatoriamente tramitadas por escrito mediante solicitud previa. El documento de aprobación de JEREMIAS España, S.A.U. debidamente firmado y sellado por el cliente en señal de conformidad, se acompañará de copias de factura y albarán del envío original.

Sin este documento oficial firmado y sellado por JEREMIAS, ninguna devolución será susceptible de ejecución.

Solo se aceptarán aquellas devoluciones remitidas a portes pagados.

Cuando una devolución es aprobada en firme, JEREMIAS España, S.A.U. efectuará el abono de dicho material en las condiciones en las que se cobró, deduciendo del mismo un porcentaje no inferior al 20% en concepto de manipulación, chequeo e inspección del material, control de calidad y recuperación sobre el valor neto del producto.



## GARANTÍA

Todos los artículos JEREMIAS España, S.A.U. están totalmente garantizados contra defectos de material o fabricación. La garantía cubre el cambio o reparación de las piezas defectuosas, así como los portes que se originen, siempre y cuando los defectos no sean causados por un uso anormal.

JEREMIAS España, S.A.U. no se responsabiliza del incumplimiento de entregas en los supuestos de caso fortuito o de fuerza mayor, tales como inundaciones, incendios, huelgas totales o parciales, etc.

Las cantidades preparadas para ser entregadas en el momento de producirse el supuesto caso fortuito o de fuerza mayor, deberán ser aceptadas por el cliente.

\*Garantía EKKOAIR: Condiciones específicas, ver anexo



## DAÑOS TRIVIALES

JEREMIAS no admite responsabilidades por daños triviales.



## PLAZOS DE ENTREGA

Los plazos de entrega son de carácter exclusivamente orientativo y JEREMIAS España, S.A.U. no se hará responsable de los daños o perjuicios derivados de posibles retrasos.

Y en ningún caso, un retraso en la entrega puede suponer una penalización para JEREMIAS España S.A.



## FABRICACIÓN ACORDE A INSTRUCCIONES DEL CLIENTE

JEREMIAS no asume responsabilidad alguna ni ofrece garantías de funcionamiento para productos fabricados bajo orden y diseño del cliente.

El cliente siempre exonerará a JEREMIAS España, S.A.U. ante reclamaciones declaradas por terceros como consecuencia de posibles daños causados por dichos productos, incluyendo esta responsabilidad de producto, siendo excepción el caso en el que el daño haya sido causado por JEREMIAS España, S.A.U. con negligencia o intento de ello.



## L.O.P.D.

Los datos personales suministrados por el cliente se mantendrán con máxima confidencialidad en los archivos de JEREMIAS España, S.A.U. conforme a la RGD 2018, referente a la protección de datos personales.

Para la corrección y/o validación de sus datos podrá contactar con nosotros a través de [info@jeremias.com.es](mailto:info@jeremias.com.es)



## JURISDICCIÓN

JEREMIAS España, S.A.U. y sus clientes se someterán expresamente a la Jurisdicción de los Tribunales y Juzgados de Bilbao, con renuncia a cualquier otro fuero o jurisdicción.

# jeremias

**Esta tarifa anula y sustituye a las anteriores.**

JEREMIAS se reserva el derecho a modificar la información contenida en este documento sin previo aviso.

**Los precios indicados en Tarifa no incluyen IVA.**

**GENERAL**

Adicionalmente a la garantía reglamentaria, Jeremias ofrece a distribuidores y compañías especializadas esta garantía de fabricante en lo que respecta a producto Jeremias (no aplicable a producto comprados a terceros). Es válida independientemente de cualquier provisión de responsabilidad obligatoria, por ejemplo como está establecido en la legislación de responsabilidad de producto, en casos de actuación dolosa, negligencia grave, lesión a la vida, daño corporal o salud por parte de Jeremias o sus agentes. Para la presente garantía de fabricante, serán considerados como distribuidores y compañías especializadas cualquier entidad legal que ha adquirido un producto para revenderlo o instalarlo a terceras partes persiguiendo su ocupación comercial o autoempleo profesional.

**GARANTÍA**

Es aplicable a productos jeremias comprados por una compañía especializada desde 01/01/2015 (recibo de compra) siempre que se demuestre que han sido instalados de una forma apropiada. Jeremias garantiza que sus productos han sido producidos a partir de materiales resistentes a la corrosión. Es indicativo en este sentido el estado del arte en el momento en que ha sido fabricado el producto. Las reclamaciones de compensación por pérdidas provocadas dentro de la responsabilidad del producto sólo alcanzarán lo indicado en las disposiciones obligatorias reglamentarias. Esta garantía es válida para un periodo no mayor de 25 años desde la fecha de compra del producto, pero inferior a 25 años y 3 meses desde la fecha de fabricación cuando la pérdida se deba a un fallo del material. El plazo de garantía no se ampliará en ningún caso, especialmente en caso de reparación o reemplazo del producto. El plazo de garantía no comenzará de cero en esos casos. Para mas información consultar el documento de garantías completo en jeremias.es

**NOTIFICACIÓN DEL DEFECTO**

La compañía especializada puede encargarse por sí misma de la ejecución de los derechos de la garantía contra Jeremias presentando una notificación escrita dentro del periodo de garantía. En este sentido hay una condición previa de que la empresa especializada notifique a Jeremias el defecto dentro de los dos meses siguientes al conocimiento del mismo. Incumbe a la empresa especializada el probar que la garantía no ha expirado (por ejemplo proporcionando el recibo de compra y una copia del informe de instalación realizado por su cliente final). Cuando sea necesario, Jeremias tiene derecho a especificar la fecha de producción como la fecha de comienzo del periodo de garantía.

**PRESTACIONES EN CASO DE GARANTÍA**

Jeremias es libre de decidir si repara el producto, lo sustituye o reembolsa el precio de compra. Normalmente, la compañía especializada, acordándolo previamente con Jeremias, reparará el fallo del producto por sus propios medios o encargará la reparación in situ a otra organización especialista. En este caso, la garantía cubre el suministro gratuito de los recambios necesarios. Si Jeremias accede por escrito a llevar a cabo la reparación, Jeremias tendrá que soportar los costes asociados con los repuestos, instalación y su propia mano de obra, y adicionalmente con cualquier coste proveniente del suministro o entrega del producto. El cliente final deberá proporcionar acceso al producto dañado. En caso de sustitución, el producto antiguo será reemplazado gratuitamente por un nuevo producto del mismo tipo, calidad y modelo. Si el producto en cuestión está obsoleto en el momento de la reclamación, Jeremias tendrá derecho a suministrar un producto similar adecuado para la aplicación. Todo transporte y entrega a y desde Jeremias y a y desde otro distribuidor, cada retirada y reinstalación del producto o cualquier otra medida especial podrá sólo realizarse con el previo consentimiento de Jeremias. Si Jeremias da consentimiento a la medida propuesta, Jeremias soportará los costes asociados a la implementación. Si no hubiese consentimiento en contra, la compañía especializada efectuará la recogida del nuevo producto en el distribuidor de Jeremias más cercano. Si Jeremias consiente a reembolsar el precio de compra y esta decisión está confirmada por escrito, el usuario devolverá el producto a Jeremias y Jeremias reembolsará el precio de compra.

**CONDICIONES Y EXCLUSIONES**

Es condición para la validez de esta garantía que el producto haya sido instalado de manera profesional y siguiendo las instrucciones de manejo/instalación y la tecnología aplicable (p.ej. por un especialista del negocio o por una compañía técnica autorizada) y el cumplimiento de las instrucciones operativas y el uso de los productos Jeremias acorde a las instrucciones técnicas, manuales de servicio y los certificados de producto suministrados por Jeremias. Estas condiciones incluyen, pero no están limitadas a, la aceptación del sistema por un deshollinador y el llevar a cabo un mantenimiento regular y trabajo de inspección, según se indica en la reglamentación vigente.

Instrucciones de montaje, instrucciones de uso e instrucciones de servicio son adjuntadas con todo producto y están disponibles en [www.Jeremias.com.es](http://www.Jeremias.com.es).

La garantía NO cubre reclamaciones por:

- Desgaste de piezas por el uso normal, p.ej. juntas.
- Trabajos de pintura.
- Partes móviles, como pueden ser compensadores, reguladores de tiro, estabilizadores, puertas de inspección, etc.
- Tubo flexible.
- Aislamiento.
- Consumibles, p.ej. granulados.
- Mercancía suministrada por otros productores.
- Desviaciones menores de la calidad esperada de los productos Jeremias que no tengan efecto en el valor práctico del producto.
- Defectos del producto causados durante la instalación, transporte y ensayo del artículo comprado
- Muestras de producto, etc.

La garantía NO será válida en caso de:

- Incumplimientos con el montaje, instrucciones de servicio y las instrucciones de uso suministradas o las disponibles para referencia en [www.Jeremias.com.es](http://www.Jeremias.com.es).
- Montaje, mantenimiento, reparación o servicio por personal no cualificado.
- Daño en el producto causado por el comprador, instalador o terceras partes.
- Daño debido al desgaste normal por el uso o daños intencionados. En caso de negligencia, será cargada una negligencia contributiva por mutuo acuerdo.
- Instalación o puesta en marcha inadecuadas.
- Mantenimiento inapropiado.
- Productos que no han sido o no están siendo usados en concordancia con el fin previsto.
- Daño debido a fuerza mayor o desastre natural, en particular, pero no exclusivamente, en el caso de daño causado por inundación, fuego o helada.

**EXCLUSIONES DE LA GARANTÍA:**

Si un defecto en el producto no es cubierto por esta garantía, los costes incurridos en el envío y transporte del producto serán pagados por la compañía especialista/distribuidor. Adicionalmente, la compañía especialista correrá con los gastos incluidos los costes de mano de obra resultantes del examen del producto así como los costes de desmantelamiento y reinstalación del producto. Si la compañía especialista/distribuidor es notificada de que no hay fundamento en la reclamación de garantía, entonces la compañía especialista deberá pagar los costes resultantes de los trabajos de reparación solicitadas así como los costes de los repuestos y mano de obra.

Si el defecto en el producto no era evidente cuando fue suministrado, Jeremias decidirá a su criterio y caso a caso si debería ser subsanado como muestra de buena voluntad. En este caso, la compañía especialista/distribuidor no está legalmente autorizado a reclamar la rectificación del defecto.

**DERECHOS LEGALES**

El usuario disfruta de derechos legales adicionales a los de la garantía. Estos derechos legales, en ciertas circunstancias, más favorables para los derechos de la compañía especialista/distribuidor no están restringidos por la garantía. La garantía tampoco afecta a los derechos del usuario contra la compañía especialista/distribuidor.

**PRECAUCIONES PREVIAS AL MONTAJE**

**¡IMPORTANTE!**

Hay que asegurarse absolutamente de que el aire ambiente y el aire de combustión no están contaminados por hidrocarburos clorados. Posibles fuentes de hidrocarburos clorados incluyen:



Fuentes industriales	
Limpieza química	Tricloroetileno, tetracloroetileno, hidrocarburos fluorados
Baños desengrasantes	Percloroetileno, tricloroetileno, cloruro de metileno
Tiendas de pintura	Tricloroetileno
Machinas refrigerantes	Cloruro de metileno, triclorofluorometano, diclorodifluorometano
Fuentes domésticas	
Agentes de limpieza y desengrasantes (detergentes, sprays de cabello)	Percloroetileno, Cloroformo metílico, Tricloroetileno, Cloruro de metileno, Tetraclorocarbonato, Ácido clorhídrico
Otros	
Disolventes	Diversos hidrocarburos clorados
Sprays y aerosoles	Hidrocarburos clorados y fluorados

Si se está quemando madera, asegurarse de que sólo se está quemando madera natural que no ha sido pintada ni conservada en ninguna manera. Asegurarse de que la madera natural ha sido almacenada al menos por 2-3 años y que no se excede de un grado de humedad residual del 20%. Se deben observar además las instrucciones de montaje y manejo y requerimientos del fabricante del calefactor.

- No se deben quemar aglomerados, desperdicios domésticos, etc.
- Es esencial que los componentes no entren en contacto con ningún metal ferrítico o metales de calidad inferior.
- Se deben manejar las piezas con el mayor de los cuidados, esto significará:
- Encontrar un lugar adecuado de almacenaje.
- Almacenar los componentes en una superficie plana y no inclinada o al menos de una manera que no pueden caer.
- Desembalar el material inmediatamente antes del montaje.
- Proteger el material en todo momento de chispas y suciedad.

**LUGAR DE EJECUCIÓN, JURISDICCIÓN Y LEY APLICABLE**

Esta garantía está sujeta a la legislación española en vigor en exclusión al tratado de las Naciones Unidas concerniente a contratos para la venta internacional de bienes (CISG) del 11 Abril 1980. El lugar de actuación de las obligaciones provenientes de esta garantía es Amorebieta - Bizkaia - España. Hasta donde sea legalmente permisible, el lugar de jurisdicción son los juzgados de Durango, subsidiariamente Bilbao, subsidiariamente País Vasco y subsidiariamente Madrid.

**Garantía**  
 COMO EMPRESA ESPECIALIZADA TE AVALAMOS CON  
**25 AÑOS**  
 EN NUESTROS SISTEMAS DE CONDUCTOS DE EVACUACIÓN (FABRICADOS EN ACERO INOXIDABLE)  
 Ver condiciones generales de garantía adjuntas.  
 Jeremias 25 Years Garantía

# ANEXO:

## CONDICIONES DE GARANTÍA APLICABLE AL PRODUCTO EKKOAIR

### GARANTÍA

Todos los artículos Jeremias están totalmente garantizados contra defectos de material, diseño, y fabricación.

La garantía cubre el cambio o la reparación de las piezas defectuosas, así como, los costes asociados que se originen, según lo previsto en las presentes Condiciones Generales.

En caso de reparación o reemplazo de una parte del producto, la garantía solo se aplicará a aquellas partes en las que se haya intervenido específicamente, dejando excluidos los elementos que no reciban algún tipo de tratamiento. Queda a la sola discreción de Jeremias si reparar o sustituir el producto o reembolsar el precio de compra. Jeremias y la compañía especializada acordarán si se encargará Jeremias con sus propios medios o ajenos la reparación del producto, de acuerdo con el Incoterm aplicable.

El periodo de garantía será de 6 meses desde que se lleve a cabo el servicio de reparación o sustitución en la pieza cubierta por la garantía.

En caso de que el producto esté cubierto por la garantía, la misma cubre el suministro gratuito de los recambios necesarios. Por el contrario, no cubre el coste de la instalación y la mano de obra, ni daños derivados de estas operaciones. El cliente final deberá proporcionar acceso al producto dañado.

En caso de sustitución, el producto antiguo será reemplazado gratuitamente por un nuevo producto del mismo tipo, calidad y modelo. Si el producto en cuestión estuviera obsoleto en el momento de la reclamación, Jeremias se compromete a suministrar un producto similar.

Se hace expresamente constar que Jeremias no asume la responsabilidad derivada de que el producto sirva para el uso pretendido por el cliente o cliente final.

### GARANTÍA LEGAL:

Es aplicable a todos los productos Jeremias.

De acuerdo con la normativa en vigor, todos los productos cuentan con una garantía de 3 años desde la fecha de entrega.

### PROCEDIMIENTO DE NOTIFICACIÓN:

Para ejercer los derechos bajo la garantía, la compañía especialista/distribuidor deberá comunicar con suficiente detalle a Jeremias el defecto comprometiéndose a:

- Notificar a Jeremias la falta de conformidad dentro de un plazo razonable, no superior a 2 semanas desde que tuviera conocimiento del defecto.
- Presentar el comprobante de compra (factura) y, en su caso, la documentación relacionada con el producto defectuoso.

### CONDICIONES PARA LA APLICACIÓN:

Es condición indispensable para la validez de la garantía que el producto haya sido instalado adecuadamente y siguiendo las instrucciones de manejo/instalación y la tecnología aplicable y el cumplimiento de las instrucciones operativas y el uso de los productos Jeremias acorde a las instrucciones técnicas, manuales de servicio y los certificados de producto suministrados por Jeremias.

Estas condiciones incluyen el llevar a cabo un mantenimiento periódico preventivo y correctivo, según se indica en la documentación.

Las instrucciones de montaje, uso y servicio son aplicables a todo producto y están disponibles en [www.jeremias.es](http://www.jeremias.es).

### EXCLUSIONES:

Quedan excluidos de la garantía los siguientes supuestos:

- Piezas de desgaste.
- Trabajos de pintura.
- Consumibles, p.ej. filtros.
- Daños eléctricos derivados de una incorrecta protección.
- Incumplimiento de las condiciones mínimas de almacenaje.
- Desviaciones menores de la calidad esperada de los productos Jeremias que no tengan efecto en el valor práctico del producto.
- Defectos del producto causados durante la instalación, transporte y ensayo del producto.
- Condiciones ambientales inapropiadas o aislamiento.
- Supuestos de fuerza mayor.
- No abono del precio.

Asimismo, la garantía no cubre los siguientes supuestos:

- Incumplimientos con el montaje, instrucciones de servicio y las instrucciones de uso suministradas o las disponibles para referencia en [www.jeremias.es](http://www.jeremias.es).
- Montaje, mantenimiento, reparación, alteración o servicio por personal no autorizado.
- Daño en el producto causado por el comprador, instalador o terceras partes.
- Daño debido al desgaste normal por el uso o daños intencionados.
- En cualquier otro caso de negligencia.
- Instalación o puesta en marcha inadecuadas.
- Mantenimiento insuficiente o incorrecto o la utilización de piezas no originales o autorizadas.
- Productos que no han sido o no están siendo usados en concordancia con el fin previsto.

- Daño debido a fuerza mayor o desastre natural, en particular, pero no exclusivamente, en el caso de daño causado por inundación, fuego o helada.
- Si el producto se instala y/o utiliza en un país distinto al acordado en el pedido.

Asimismo, Jeremias no cubre los daños indirectos que pudieran producirse en la aplicación de la garantía (tales como lucro cesante o pérdida de beneficios, penalizaciones por retraso, etc.).

Si un defecto en el producto no queda cubierto por esta garantía, los costes incurridos por Jeremias, incluidos los costes de mano de obra resultantes del examen del producto, así como, los costes de desmontaje y reinstalación del producto deberán ser asumidos por la compañía especialista/distribuidor/cliente.

Si la compañía especialista/distribuidor/cliente es notificada por Jeremias de que no hay fundamento o causa por parte de Jeremias en la reclamación de garantía, la compañía especialista/distribuidor/cliente deberá sufragar los costes resultantes de los trabajos de inspección y reparación solicitados, así como, los costes de los repuestos y mano de obra resultantes.

Si el defecto en el producto no era evidente cuando fue suministrado, Jeremias decidirá a su solo criterio y caso a caso si corregirlo o no. En este caso, la compañía especialista/distribuidor/cliente no estará legalmente autorizada a reclamar la rectificación del defecto.

Jeremias garantiza que sus productos han sido fabricados a partir de materiales resistentes a la corrosión.

### LUGAR DE EJECUCIÓN, JURISDICCIÓN Y LEY APLICABLE

Esta garantía está sujeta a la legislación española en vigor en cada momento, excluyéndose el tratado de las Naciones Unidas concerniente a contratos para la venta internacional de bienes (CISG) del 11 de abril de 1980. El lugar de actuación de las obligaciones provenientes de esta garantía es Iurreta - Bizkaia - España. Hasta donde sea legalmente permisible, el lugar de jurisdicción son los juzgados de Durango, subsidiariamente Bilbao, subsidiariamente País Vasco y subsidiariamente Madrid.

**ekkoair**  
by jeremias

En **JEREMIAS** somos especialistas en grandes proyectos.

La experiencia de más de 45 años de dedicación al desarrollo de importantes proyectos, tanto a nivel nacional como internacional, nos otorga una ventaja frente a nuestros competidores a la hora de desarrollar cualquier proyecto de estas características.

**Hospitales** H. Monte Príncipe (Madrid), Clínica Belén (Madrid), H. Urduliz (Vizcaya), Hospital Monte Príncipe (Madrid), H. Fuenlabrada (Madrid), H. Gil Casares (Santiago de Compostela), H. Quirúrgico (Santiago de Compostela), H. Provincial (Santiago de Compostela), H. Dominguez (Pontevedra), H. Poniente (El Ejido), H. transfronterer de Puigcerda (Girona), H. San Juan de Dios (Pamplona), H. de Burgos; H. de Cruces (Vizcaya), H. de Mieres (Asturias), MD Anderson Center (Madrid), H. de Santa Maria (Lisboa), H. Centro Materno Infantil (Oporto), H. de Cabra (Córdoba), H. del sur Tenerife , H. de LLiria (Valencia), H. Clinic (Barcelona), H. Alcalá de Henares (Madrid), H. Infanta Margarita de Cabra (Córdoba), H. Imed (Valencia), H. La Fe (Valencia) **Edificios emblemáticos** Nuevo San Mamés (Bilbao), Estadio Wanda Metropolitano (Madrid), Torre Iberdrola (Bilbao), Congreso de los Diputados (Madrid), Estadio Santiago Bernabéu (Madrid), Sede central de Abengoa (Sevilla), Basque Culinary Center (San Sebastián), Reina Sofía (Madrid), Mutua Madrileña - Edificio Pirámide (Madrid), Teatre Nacional de Catalunya, Wold Trade Center (Zaragoza), Sede BBVA Tres Cantos (Madrid) , Cava Mas Tinell (Villafraña del Penedés), Fundación Botín (Santander), Edificio Tabakalera. (San Sebastian) **Centros Comerciales** Centro Comercial Marineda City (A Coruña), C.C. Colmenar Viejo (Madrid), C.C. La Albufera (Madrid), C.C. Parque Ferrol (Ferrol), C.C. Castellana 200 (Madrid), C.C. Planetocio Collado Villalba (Madrid), Mercat dels Encants (Barcelona), Corte Inglés Córdoba, Corte Inglés Zaragoza, C.C. Porto Venecia (Zaragoza), C.C. Bandeira (Vigo), Bricor (Badajoz), Platea (Madrid), C.C. Las Glorias (Barcelona), Progreso 414 Urban Market Espacio Gourmet (Vigo) **Hoteles** Hotel Único (Madrid), H. Blue (La Coruña), H. galgos Meliá (Madrid), H. Olivia Balme (Barcelona), H. Villa Mandy Adeje (Tenerife), H. Timanfaya Yaiza (Lanzarote), H. H10 (Tenerife), Ibiza Gran Hotel (Ibiza), H. Sole. (La Pobra de Segur), Poshtel Bilbao - Premium Hostel (Bilbao), H. Pompaelo (Pamplona), H. Barceló Sants (Barcelona) **Universidades** IBIS Instituto de Biomedicina (Sevilla), U. Virgen del Rocío (Sevilla), U. Santiago de Compostela, UNED (Ourense), Residencia universidad Rey Juan Carlos (Madrid), District-heating U. Camilo Jose Cela (Madrid), Filmoteca TVE Pozuelo de Alarcón (Madrid), U. de Deusto (Bilbao), IES Las Rozas (Madrid) **Infraestructuras** Aeropuerto de Santiago de Compostela Aeropuerto de Alicante, Aeropuerto de El Prat (Barcelona), Aeropuerto de Málaga, Base Aérea de Torrejón de Ardoz, Aeropuerto Madrid T1, Estación del Ave (Logroño), Túneles del AVE (Barcelona), Túnel beiramar (Vigo), Cocheras metro (Sopelana), Nuevos Talleres Renfe (Valladolid) Ecoenergía zona franca (Barcelona), Grupos electrógenos Interxion España (Madrid) **Otros** Centro de Alto Rendimiento (Pontevedra), Residencia cantera Real Madrid (Madrid), Cogeneración Riudellots de la Selva (Gerona), District-heating Fira Gran Via (Barcelona), Centro penitenciario Archidona (Málaga), APC Europe (Albacete), Edif. Mapfre Majadahonda (Madrid), Fabrica de "El Pozo" (Murcia), Fabrica Volkswagen (Pamplona), CPD Telefónica Alcalá de Henares (Madrid), CPD Telefónica (Rubi), CPD Inditex (Arteixo), Fabrica Campofrio (Soria), Fábrica de BIMBO (Madrid), Piscina Salto del Caballo (Toledo), Panadería Maspalomas (Gran Canaria), Restaurante Edificio Iberia (Madrid), Restaurante Tatel (Madrid), Restaurante Jubany - Nando Jubany (Barcelona), Restaurante La Poma (Barcelona), Restaurante Leka (Barcelona), Restaurante Barlovento (Coruña), Restaurante Fire Capitano (Coruña), Gasthof (Coruña), Restaurante Lluerna (Santa Coloma de Gramenet) ...



